

# Blind Navigation System by using RFID and Digital Compass Technology

A.M Kassim, T. Yasuno, C. X. Zhi, J.J.S.W. Lun, A.Z. Shukor

The University of Tokushima  
2-1 Minamijyousanjima-cho,  
Tokushima 770-8506, JAPAN

anuar@utem.edu.my / anuar@ee.tokushima-u.ac.jp

## Abstract

This paper describe the RFID technology which is applied to guide the visually impaired person at indoor and outdoor environment. In order to provide an efficient and user-friendly navigation tools, it is proposed to design and develop a navigation device using RFID network with the digital compass to guide visually impaired person walking properly via audio navigation. The idea of positioning and localization with digital compass and direction guiding through voice commands is implemented in this design. The study focuses on the calibration of the compass and relocates the visually impaired person back to the normal route if they are out of the direction. Data analysis will be done during the evaluation of the navigation device and assessment will be made improve the performance of the device. This project is beneficial to visually impaired person because the navigation device designed with voice commands will helps them to have a better, safer and comfortable travel.

## 1 Introduction

In early 2010, the Organization of the United Nations (UN) has been released the statistic that people with disabilities (PWDs) in the world are ten percent of the total population. Therefore, 80 percent of the disabled are located in developing countries from the calculated number. In addition, instead of Malaysia has a population of about 28 million people, the number of disabled persons in Malaysia is estimated at 2.8 million people. However, the numbers of people with disabilities which are registered with the Social Welfare Department of Malaysia are only about 380 thousand people which are 12 percent of the estimated population of the disabled in this country [1]. This total number does not reflect to the real situation of disabled people in this country because the disabilities person are not freely travel by themselves.

The disabled should be given priority, but in the context of Malaysia, disabled people are not advanced, but often ignored. Malaysia has signed the Convention on the Rights of Disabled Association of the United Nations, but the rights of disabled persons are not

granted equally. The convention guarantees that the disabled enjoy equal opportunities with those efforts as well as full and effective participation in society in all aspects of life - accessibility, mobility, health, education, employment, rehabilitation and participation in the political, economic and socio-cultural. The disable person can be categorized in some classes such as deaf, blind, physically disability and etc.

However, almost of disabilities who always involved in great danger is visually impaired person. They usually rely on a cane or guide dog to assist them in reaching desired destination safely. However, this method is beneficial if only if the path to the destination is already familiar or known. It becomes difficult once the destination is new especially the environment is not designed for blind people. It is very hard for them to travel independently from one to another destination without the proper navigation tools. Therefore, the advanced technology developed by researcher benefits the visually impaired people to travel independently.

The design challenges for the blind navigation device are real-time guidance, portability, power limitations, appropriate interface, and continuous availability, no dependence on infrastructure, low cost solution and minimal training [2]. There are several designs to help visually impaired people to achieve self-independence traveling at indoor environment. Location technology such as Radio frequency identification (RFID), Infrared Data Association (IrDA), Bluetooth or Wi-Fi has been developed to help them travel during indoors with contextual information or sound navigation.

In addition, the usage of Global Positioning System (GPS) device also can help to guide the visually impaired person in an outdoor environment. Since GPS cannot function properly in indoor spaces, other researchers present the solution by using Infrared Data Association (IrDA) technology which works as sensors to determine the indoor location. The Drishti system is the combination of GPS for outdoor navigation and ultrasonic sensor for indoor navigation. One of the problems about GPS is the error with the measurement taken especially inside the tall buildings [3].

Furthermore, BLI-NAV a blind navigation system designed which consists of GPS receiver and path detector. Both devices used to detect user's location

and determine the shortest route to destination. Voice command is given throughout the travel. Path algorithm is used to determine the shortest distance from start point to end point together with path detector. Moreover, user is able to avoid obstacles while traveling [4]. This system gave the better results in real time performance and improves the efficiency of blind travel at indoor environment.

On the other hand, Pocket-PC based Electronic Travel Aid (ETA) proposed to help visually impaired person to travel at indoor environments. Pocket-PC will alert the user when near the obstacles through warning audio [5]. An ultrasonic navigation device for visually impaired people is designed. The micro-controller built in device can guide the user in which route should be taken through speech output. Besides, the device helps to reduce navigation difficulties and obstacles detection using ultrasounds and vibrators. Ultrasonic range sensor is used to detect surrounding obstacles and electronic compass is used for direction navigation purpose. Stereoscopic sonar system is also used to detect nearest obstacles and it sends back feedback to tell user about the current location [6] ~ [11].

In, addition, Blind Assistant Navigation System that can help visually impaired people navigates independently at indoor environment also developed [12]. The system provides the localization by using wireless mesh network. The server will do the path planning which then communicates using wireless with the portable mobile unit. The visually impaired person can give commands and receive response from the server via audio signals using headset with microphone. The proposed RFID technology in order to design the navigation system by providing information about their surroundings also developed [13] ~ [16]. The system uses the RFID tag reader that installed on the white cane to read the tags that are installed on the tactile paving.

Besides, INSIGHT is the indoor navigation system to assist the visually impaired person to travel inside the buildings. The system used RFID with Bluetooth technology to locate the user inside the buildings. The personal digital assistant (PDA) such as mobile device used to interact with INSIGHT server and provide navigation information through voice commands. The zone that user walked will be monitored by the system. The system will notify the user if user travels the wrong direction. The RFID network can help to determine the shortest distance from current location to the destination. Besides the system can help to find the way back if they lost their direction and recalculate the new path [17].

In this paper, the blind navigation device is designed and developed for visually impaired people to navigate from one place to another place independently for indoor and outdoor environment. The transformation of the conventional white cane to blind navigation device which consists of RFID detector, digital compass and voice module system. In order to provide an efficient and user-friendly navigation tools, this paper proposed to design and develop a naviga-

tion device using RFID network with the digital compass to guide visually impaired person walking properly via audio navigation. The idea of positioning and localization with digital compass and direction guiding through voice commands is implemented in this design. The study focuses on the calibration of the compass and relocates the visually impaired person back to the normal route if they are out of the direction. Data analysis will be done during the evaluation of the navigation device and assessment will be made improve the performance of the device.

## 2 Blind Navigation System

### 2.1 Developed Navigation system for Blind

In order to developed the navigation system which is benefit to the visually impaired person, the total system such as path planning system, RFID detection system, obstacle detection system is needed. However, in this paper, the developed navigation system is only one part of total navigation system which not including path planning system, obstacle avoidance system, and localization system and etc. Here, the developed system are focused on RFID detection system and digital compass which is used to guide the right way for visually impaired person when travel alone. Figure 1 illustrated the system configuration of one part of navigation system which including the RFID detection system and digital compass.

In the developed navigation system, there are some components is used such as RFID reader, micro-controller, voice module, Braille keypad and etc. A micro-controller functions as integrated circuit that contains the memory and programming is used to communicate with hardware. The type of micro-controller which is used in this project is ARDUINO Pro Mini. The selection of this micro controller because of the compact size, light and enough input/output (I/O) port to develop the navigation device. Besides, the RFID detection module (MiFare High Frequency 13.56 MHz) consists of RFID tag reader and tags play important role for the blind navigation.

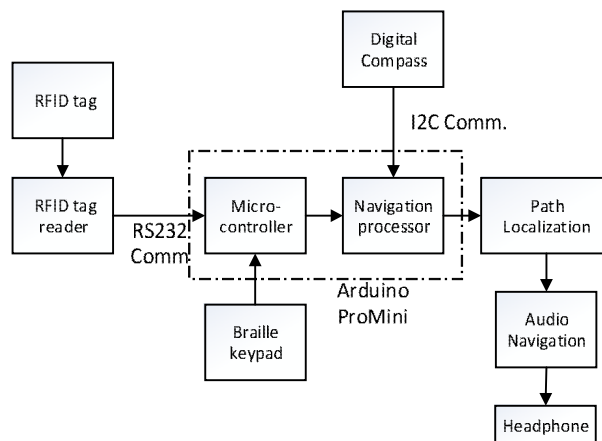

Fig.1 System overview of the blind navigation device

Figure 2 shows the RFID detection system consists of RFID tag reader and RFID tags. The RFID

tag reader is directly connected to ARDUINO micro-controller. The RFID tag reader is activated when the ARDUINO micro-controller is powered on. The RFID tag reader is installed at the bottom of the electronic cane in order to detect the RFID tag easily which are installed on the tactile paving. Each RFID tags contained the stored information of location and surrounding environment like obstacles, place name, building name and etc. The RFID tag reader will read the code of the tags and the code encryption will be done by the programming inside the micro-controller. The information of the places which the RFID tag have been mounted will be prepared as a library inside the micro-controller.

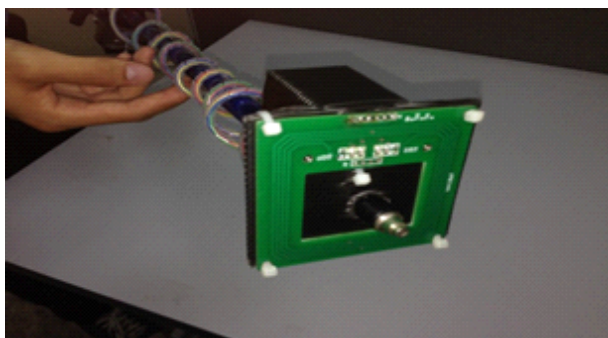

Fig. 2 RFID Tag Reader

In order to navigate to the desired location, the user will set the desired destination at start point after detecting the nearest RFID tag. RFID tag reader is activated to read the tag. Each RFID tag has its own identification code and the code is transferred to ARDUINO micro-controller through RS232 for identification code encryption. After that, the controller system proceeds to the navigation processing. The information extracted will be then reprocessing and converted into voice commands. Then, the users will receive the commands on how to travel their path and the information about the surrounding environment. The voice module (WTV020) is used in order to play the voice commands and inform the users which the direction that they should be taken and turn when the corner. The voice command which is played are pre-programmed inside the voice module.

In addition, the digital compass (HMC6352) is used because it can provide the high degree heading resolution and accurate in determining the direction. If the user travels out from the path, the navigation system will determine the direction heading and gives alert to user. Once the direction is correct, user can continue their travel by the aid of sound navigation. Figure 3 shows the illustration of the developed electronic cane which will be used in this research. A conventional white cane is transformed to the electronic cane in order to attached all the developed system. At the end point of the white cane, a wheel is mounted in order to make the developed RFID reader easily detected the RFID tags and the user no need to raise and swing the white cane while travel.

### 3 Proposed Control System for Navigation System

#### 3.1 System flow chart

Figure 4 shows the process flow chart of the designed and developed navigation device. In order to used the developed navigation device, the RFID tag reader will be initialized respectively. Once the tag reader has been initialized, the tag reader will be activated. The tag reader will determine the user's starting point once the user tap the RFID tag reader to the nearest RFID tag around them. If the RFID tag reader failed to do read the tag even RFID tag are already in the detection range, the device will go back to the tag reader activation process by initialize the RFID tag reader first. On the other hand, if the next RFID tags are successfully detected, the ARDUINO micro-controller will carry out the encryption of the tag identity.

Them once the RFID tag is detected, the user can determine where he or she wants to go by input the desired location through developed Braille keyboard or voice recognition device. Figure 5 shows the modified keypad with Braille Code. This Braille writing system is attached and connected on the top the 4 x 4 numeric keypad. It is special modified for key in the destination with the combination alphabet "T, A, N, D, S, U, R, M, P, L, F, O, K, E, L, #" which can be inputted as desired destination such as TANDAS, PLATFORM, ATM and etc. All the desired destination have been pre-programmed in the library of the micro-controller. The users need to key in the destination on the modified keypad with the Braille code and the device will start to give the guidance to the visually impaired people through headphone.

After the identity encryption process is succeed, the device process to path localization will lead to user's desired destination guided by voice commands which will be given through headphone. In case the user travels at the wrong path, the process will proceed to route processing subroutine. In the route processing subroutine, digital compass is activated by initialize the serial communication from the ARDUINO main board. The magneto sensor inside the digital compass will measure the angle deviation and recalculate the correct heading direction. If there is no more angle deviation, the user can continue his or her travel through voice commands until reach the destination and vice-versa.

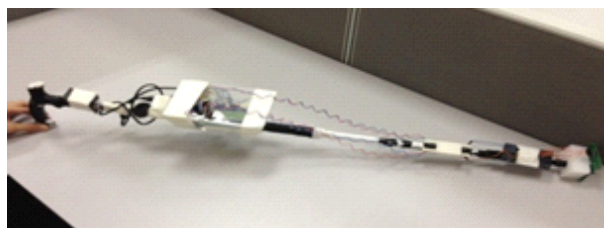

Fig. 3 Electronic Cane

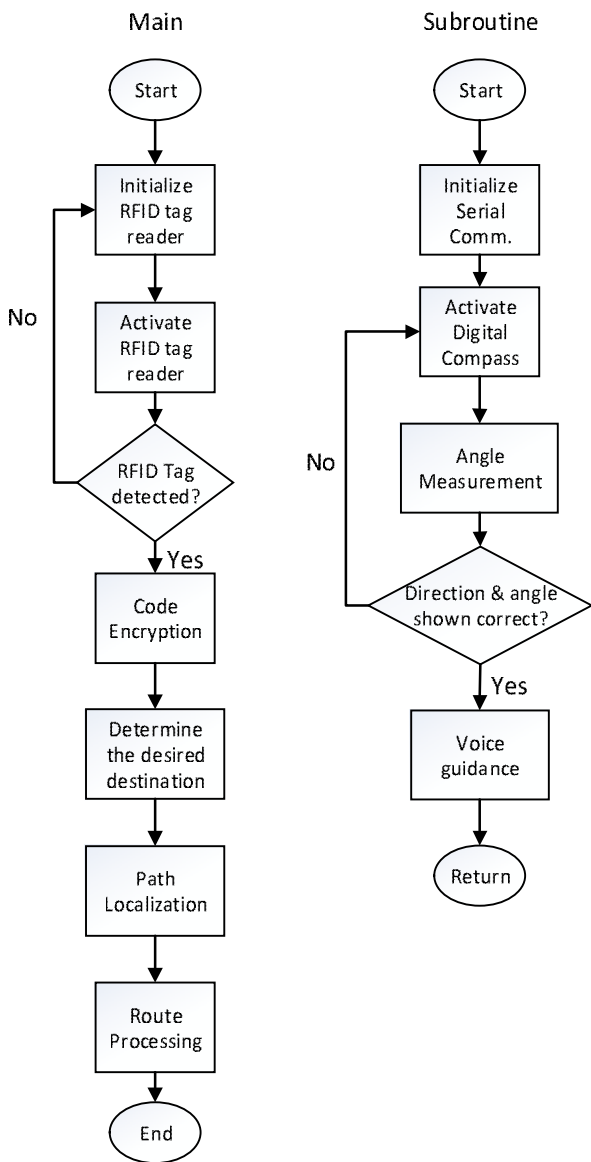

Fig. 4 Process Flow Chart

### 3.2 Experimental Setup

In order to optimize the functionality of the blind navigation device for guiding the visually impaired people in the correct direction throughout the travel, the experiment setup to evaluate the accuracy of the digital compass is set. Figure 6 shows the digital compass setup and the reference compass, respectively. The digital compass is connected to the ARDUINO micro-controller to obtain the analog signal and convert it back to the digital signal by using the onboard analog Digital Converter (ADC). The digital signal will be displayed on the serial monitor of ARDUINO and then the digital compass can be tuned. The digital compass is fixed at the certain point where the RFID tag has been mounted to ensure the digital compass is always pointing at the North. The compass which inside the IPHONE is used as the reference compass in order to make comparison when calibrate the digital compass.

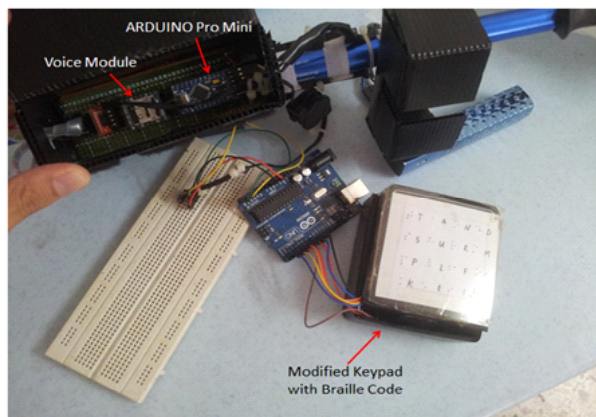

Fig. 5 The modified keypad using Braille character

## 4 Experimental Results

### 4.1 Performances of Compass Technology in Navigation System

Table 1 shows the compass accuracy test results when the digital compass is pointing to North. From the table, the compass reading clearly shows that the resolution of the digital compass is high and able to produce the compass reading in two significant values. The repeatability test is carried out about 20 times to prove that the results are valid to be used in the navigation device. Besides, the accuracy test for the digital compass have been done 20 times at different places and different time. In the result also shows that the relative error is getting smaller and close to the desired North degree because of the digital compass output are getting stable. This implies that the digital compass is suitable to use for blind navigation to provide accurate heading direction.

Note : North direction point to  $0^\circ$  or  $360^\circ$   
 Mean of 20 times Repeatability =  $358.27^\circ$   
 Mean of Percent Relative Error =  $0.4805\%$

Figure 7 shows the percent relative error % of the

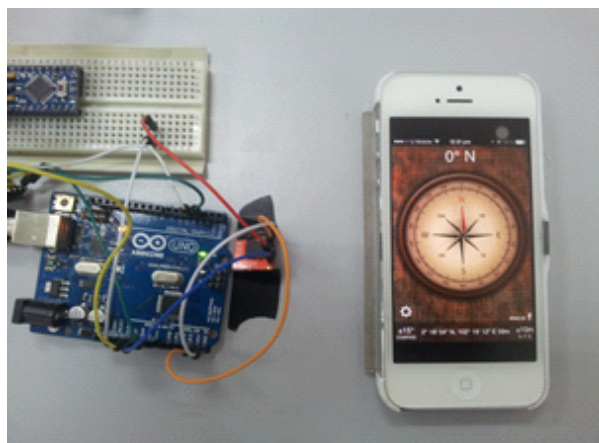

Fig. 6 Digital compass setup and the reference compass

Table 1 Compass Accuracy Test Results

Times	Pointing to North	Degrees North	Relative Error	Percent Relative Error
1	Yes	356.30	3.70	1.0278
2	Yes	356.40	3.60	1.0000
3	Yes	356.30	3.70	1.0278
4	Yes	355.70	4.30	1.1944
5	Yes	358.20	1.80	0.5000
6	Yes	357.80	2.20	0.6111
7	Yes	357.70	2.30	0.6389
8	Yes	357.80	2.20	0.6111
9	Yes	358.20	1.80	0.5000
10	Yes	357.90	2.10	0.5833
11	Yes	359.20	0.80	0.2222
12	Yes	359.30	0.70	0.1944
13	Yes	359.20	0.80	0.2222
14	Yes	359.30	0.70	0.1944
15	Yes	359.30	0.70	0.1944
16	Yes	359.20	0.80	0.2222
17	Yes	359.20	0.80	0.2222
18	Yes	359.60	0.40	0.1111
19	Yes	359.40	0.60	0.1666
20	Yes	359.40	0.60	0.1666

readings obtained from the digital compass when it is pointing to the North. The maximum peak of the percent relative error is 1.1944%. The average percent relative error is 0.4805%. The graph shows the percent relative error is decreasing gradually towards the end and becomes nearly constant between the 11 and 17 times of trials. This implies that the relative error is getting smaller and the readings are very close to the  $360^\circ$  when the digital compass points to the North. The data obtained is said to have high reliability. Besides, the digital compass has very high sensitivity and able produce significant value at tenth decimal places.

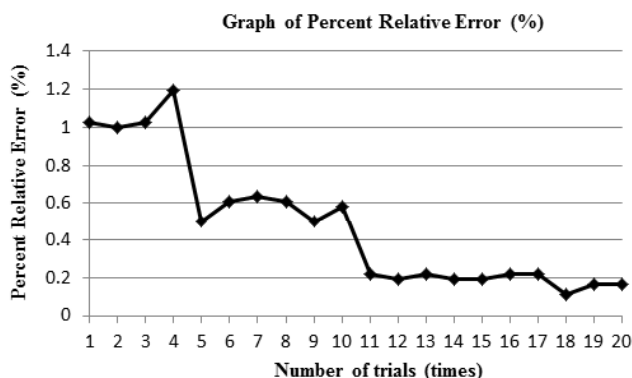

Fig. 7 Percent Relative Error of Digital Compass pointing to North

#### 4.2 Performance of navigation system in field test

From the table which shown the validity of the digital compass which can be used inside the developed navigation system, the developed navigation system is evaluated for its performance at the real field by using the RFID tag that have been installed on tactile paving. The navigation device built with digital com-

pass for direction guidance and voice module able to inform user about the direction. Figure 8 shows the illustration of the developed navigation device when go forward towards North direction at the starting point and 90 degree junction. The digital compass will able to detect the error if the user travels out of the direction and the misdirection lead to the wrong path. Thus, the voice module will inform the user, "WARNING!" repeatedly and alert user from taking the wrong path. The navigation proceeds until the user turn over and travel on the right direction.

Here, the traveling time which is consumed to finished the route is measured. The travel distance which is needed to be done is 240 cm. There are two subjects which have been tested at the field which are human and robot. RFID tag reader are attached at the bottom of the robot in order to easily detect the RFID tag. Then, RFID tag reader read the tags first and at the same time the ARDUINO micro-controller will synchronize with the digital compass for route processing. For experiment by using a robot, the comand are given to the DC motor in order to go straight or turn. However, for human, the voice module will inform the user how to turn at the corner, e.g. "90 degree Turn Left" or "90 degree Turn Right". Through this experiment, the high accuracy of the digital compass is able to give direction fast and precise. The average traveling time which is recorded for robot is 32 sec while for human is 47 second.

From this result, the difference which can be related is the size of the subject. The robot which is used are wheeled robot which sized 20cm in diameter. However, the human subject which are tested in this experiment are 170 cm in height and the position of human is 40 cm behind the end of the electronic cane. Therefore, the human subject is quite difficult to turn when the voice command is given the turning command. Meanwhile, the robot is easily to turn because the robot can turn at the same axis when the command which are given to the DC motor, respectively.

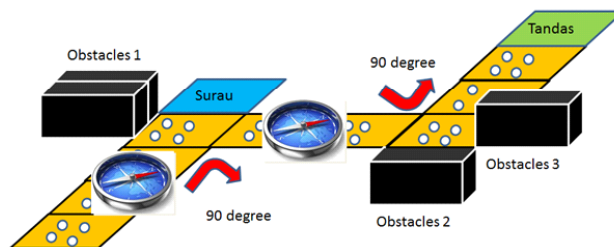

Fig. 8 Illustration of the field test layout

## 5 CONCLUSION

In this paper, the experimental study of the developed navigation device is studied and evaluated.

The digital compass which is used is able to provide accurate direction which help to guide the visually impaired during traveling independently. The RFID detection system is beneficial to the visually impaired person since the visually impaired people are provided the feedback information about the current location and the surrounding obstacles. Besides, the performance evaluation for the human and robot subject also have successfully done.

In the future, the implementation of the shortest path algorithm can be applied on the blind navigation device with RFID technology. The design of the blind navigation device can have improvement in terms of weight and sustainability design concept. Then, the blind navigation device with RFID technology supported with shortest path algorithm will be conducted to ensure them to have a better and comfortable travel at indoor environment.

### Acknowledgement

*This research was supported by grant from University Technical Malaysia Melaka award no.PJP/2013/FKE (9C)/S01184 and also technically support by the member from The University of Tokushima, Japan.*

### References

- [1] WHO secretariat (2012), "WHO — Visual Impairment and Blindness." 2012.
- [2] E. Wise et al., "Indoor Navigation for the Blind and Vision Impaired: Where are we and where are we going?," in Indoor Positioning and Indoor Navigation (IPIN), 2012 International Conference on, 2012, pp. 1–7.
- [3] M. Sarfraz and S. A. J. Rizvi, "Indoor Navigational Aid System for the Visually Impaired," in Geometric Modeling and Imaging, 2007. GMAI '07, 2007, pp. 127–132.
- [4] S. S. Santhosh, T. Sasiprabha, and R. Jeberson, (2012) "BLI-NAV embedded navigation system for blind people," Recent Advances in Space Technology Services and Climate Change (RSTSCC) 2010, pp. 277–282.
- [5] M. H. Choudhury, D. Aguerrevere, and A. B. Barreto, (2004) "A Pocket-PC Based Navigational Aid for Blind Individuals," 2004 IEEE Symposium on Virtual Environments, Human-Computer Interfaces and Measurement Systems (VECIMS), pp. 43–48
- [6] M. Bousbia-Salah, A. Redjati, M. Fezari, and M. Bettayeb, (2007) "An ultrasonic navigation system for blind people," 2007 IEEE International Conference on Signal Processing and Communications ICSPC, pp. 1003–1006.
- [7] A.M Kassim and M.S Jamri and M.S.M Aras and M.Z.A Rashid (2012) "Design and Development of Vibration Method for Vehicle Reverse System (VRS)" Journal of Procedia Engineering, 41, pp. 1114-1120.
- [8] A.M Kassim, M.S Jamri, M.S.M Aras, M.Z.A Rashid, MR Yaacob (2012) "Design and development of obstacle detection and warning device for above abdomen level" 2012 12th International Conference on Control, Automation and Systems (ICCAS), pp. 410–413
- [9] A.M Kassim, Jamaluddin, M.H. ; Yaacob, M.R. ; Anwar, N.S.N. ; Sani, Z.M. ; Noordin, A. (2011) "Design and development of MY 2 nd EYE for visually impaired person" 2011 IEEE Symposium on Industrial Electronics and Applications (ISIEA), pp. 700–703
- [10] A.M. Kassim, H. I Jaafar, M.A. Azam, N. Abas, T.Yasuno (2013), "Performances study of distance measurement sensor with different object materials and properties" 3rd IEEE International Conference on System Engineering and Technology (ICSET), pp. 281-284
- [11] M.R Yaacob, N.S.N Anwar, A.M Kassim (2012) "Effect of Glittering and Reflective Objects of Different Colors to the Output Voltage-Distance Characteristics of Sharp GP2D120 IR" ACEEE International Journal on Electrical and Power Engineering, 3 (2). pp. 6-10.
- [12] M. Shamsi, M. Al-Qutayri, and J. Jeedella, (2011) "Blind assistant navigation system," 2011 1st Middle East Conference on Biomedical Engineering (MECBME), pp. 163–166.
- [13] S. Chumkamon, P. Tuvaphanthaphiphat, and P.Keeratiwintakorn, (2008) "A blind navigation system using RFID for indoor environments," 5th International Conference on Electrical Engineering/ Electronics, Computer, Telecommunications and Information Technology. vol. 2, pp. 765–768.
- [14] A.M. Kassim, H. I Jaafar, M.A. Azam, N. Abas, T.Yasuno (2013), "Design and Development of Navigation System by using RFID Technology" 3rd IEEE International Conference on System Engineering and Technology (ICSET), pp. 258–262
- [15] A.M Kassim, A.Z Shukor, C.X Zhi, T Yasuno (2013) "Exploratory Study on Navigation System for Visually Impaired Person" Australian Journal of Basic & Applied Sciences, 7 (14) pp. 211–217
- [16] A.M Kassim, A.Z Shukor, C.X Zhi, T Yasuno (2013) "Performance Study of Developed SMART EYE for Visually Impaired Person" Australian Journal of Basic & Applied Sciences, 7 (14) pp. 633–639
- [17] A. Ganz, S. R. Gandhi, C. Wilson, and G. Mullett, "INSIGHT: RFID and Bluetooth enabled automated space for the blind and visually impaired," 2010 Annual International Conference of the IEEE Engineering in Medicine and Biology Society (EMBC), pp. 331–334.