



DIFFERENTIAL EVOLUTION TECHNIQUE OF HEPWM FOR THREE-PHASE VOLTAGE SOURCE INVERTER

Azziddin M. Razali, Norazelina Kamisman, Jurifa Mat Lazi and Norhazilina Bahari

Department of Power Electronics and Drives, Faculty of Electrical Engineering, Universiti Teknikal Malaysia Melaka, Malaysia

E-Mail: azziddin@utem.edu.my

ABSTRACT

This paper presents the execution of Differential Evolution (DE) algorithm in order to understand the principle operation of Harmonic Elimination Pulse-Width Modulation (HEPWM) switching technique. HEPWM utilizing the DE technique is proposed to eliminate low frequency harmonic components of three-phase inverter output voltage. Explanation of DE algorithm execution is given and the best approach of mutation strategy used in DE has been investigated. Switching angles of HEPWM are calculated offline by using the DE technique. Subsequently, the calculated switching angles are used to operate the three-phase voltage source inverter. Computation of DE algorithm and simulation of voltage source inverter using the calculated switching angles are carried out by using Matlab/Simulink software package. Simulation results show the effectiveness of proposed DE technique in eliminating the low order harmonic components of output voltage for three-phase voltage source inverter.

Keywords: differential evolution, harmonic elimination pulse width modulation, switching technique, voltage source inverter.

INTRODUCTION

The Harmonic Elimination Pulse Width Modulation (HEPWM) switching technique has gained a lot of interest from many researchers due to its ability in generating low Total Harmonic Distortion (THD) of output voltage for single phase and three-phase inverter. HEPWM provides direct control of the output harmonics by utilizing a few arrangements of switching angles to eliminate undesirable harmonic components. HEPWM appears likely to be best suited for medium and high power application due to its predominant harmonic performances (Amjad, Salam, and Saif, 2015; Debnath and Ray, 2012; Moeed Amjad and Salam, 2014; Mohd Rashid, Hiendro, and Anwari, 2012). The first harmonic frequency of HEPWM is almost half compared to Sinusoidal Pulse Width Modulation (SPWM) for the same switching frequency. Accordingly, the HEPWM technique will reduce the switching losses of inverter (Amjad *et al.*, 2015; Moeed Amjad & Salam, 2014).

There are a few computational strategies for HEPWM proposed by researchers. Computational strategies for the HEPWM can be divided into two categories, namely the calculus and the optimization based techniques. Calculation using Newton Raphson method is normally employed in calculus based technique (Amjad *et al.*, 2015; Bahari, Salam, and Taufik, 2010; Debnath and Ray, 2012; Moeed Amjad and Salam, 2014; Mohd Rashid *et al.*, 2012). It gives accurate result of switching angles when the initial angle values are chosen closed to global minima. Failing in guessing the suitable initial angles will lead to the non-convergence calculation result. Walsh method is also falling under the calculus based technique. It needs proper initial guessing angle values (Tsornng-Juu, O'Connell, and Hoft, 1997).

Walsh utilizes a linear equation of the Pulse Width Modulation (PWM) switching waveform which in contrast with the Newton Raphson method that employs a nonlinear equation to calculate the switching angles of

HEPWM. The optimization technique of soft computing provides significant advantage because the technique does not need any initial guess value in calculating the switching angles. In this way, this strategy will reduce the chances of non-convergence problem during the calculation process. Genetic Algorithm (GA), Particle Swarm Optimization (PSO) and Differential Evolution (DE) are a few examples of soft computing techniques (Amjad *et al.*, 2015; Debnath & Ray, 2012).

Differential Evolution (DE) algorithm is a population based search strategy presented in (Patel and Hoft, 1973, 1974). The DE technique is easy to perform and comprises an efficient evolutionary algorithm. The DE has superior advantages because of its capability to deal with non-differentiable, non-linear and multi modal objective function. Basic operation of DE is similar with GA but the mutation operation of DE is significantly different with GA (Qin, Huang, and Suganthan, 2009; Storn, 1996; Youyun and Hongqin, 2009). Performance of DE is depending on the mutation operation which is the most important strategy in DE algorithm (Mohd Rashid *et al.*, 2012).

HARMONIC ELIMINATION PULSE WIDTH MODULATION (HEPWM)

The HEPWM switching technique will eliminate the odd number of harmonic components from the inverter output line voltage. The quarter wave symmetry of output voltage waveform is utilized in DE algorithm to reduce the computational effort during calculation process.

All the triplen harmonics from line to line voltage are cancelled in the three-phase system. Only the non-triplen and odd harmonic number exist (Amjad *et al.*, 2015). Figure-1 shows the generalized output voltage waveform of the three-phase inverter. The falling edge transition is determined by the odd switching angles (α_1 , α_3 and so on). The rising edge transition is determined by the even switching angles (α_2 , α_4 and so on).

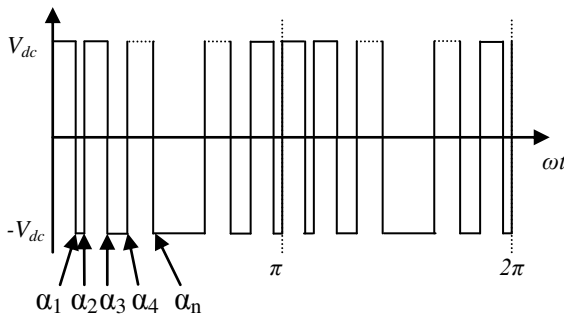

Figure-1. Generalized HEPWM quarter-wave symmetric waveform.

$$A_n = \frac{4}{n\pi} [-1 - 2 \sum_{k=1}^N (-1)^k \cos(n\alpha_k)], n \text{ is odd} \quad (1)$$

A generalized Fourier series of the n th harmonic is given as above, where the α_k is the k th switching angle, n is the harmonic order and N is number of switching angle per quarter-cycle. The number of harmonics eliminated depending on N switching angle per-quarter cycle. By solving N switching angle from equation 1, $(N-1)$ harmonic will be eliminated from the waveform. The equation needs to be equated to zero for any $(N-1)$ harmonics and to determine the value of fundamental, $NP1$. The equations to solve N switching angles $\alpha_1, \alpha_2, \dots, \alpha_N$ are as follows:

$$\begin{aligned} f_1(\alpha) &= \frac{4}{n\pi} \left[-1 - 2 \sum_{k=1}^N (-1)^k \cos(n\alpha_k) \right] - M = \varepsilon_1 \\ f_2(\alpha) &= \frac{4}{n\pi} \left[-1 - 2 \sum_{k=1}^N (-1)^k \cos(n\alpha_k) \right] = \varepsilon_2 \\ f_N(\alpha) &= \frac{4}{n\pi} [-1 - 2 \sum_{k=1}^N (-1)^k \cos(n\alpha_k)] = \varepsilon_N \end{aligned} \quad (2)$$

Where the variable ε to ε_N are normalized magnitudes (with respect to the fundamental) of the harmonic to be eliminated. $M=V_1/V_{dc}$ is the modulation index. V_1 is the amplitude of the fundamental component and V_{dc} is the DC input voltage.

The objective function constructed for optimization is defined by:

$$f(\alpha_1, \alpha_2, \alpha_3, \dots, \alpha_N) = \varepsilon_1^2 + \varepsilon_2^2 + \varepsilon_3^2 + \dots + \varepsilon_N^2 \quad (3)$$

The solution must satisfy the following constraint:

$$0 < \alpha_1 < \alpha_2 < \alpha_3 \dots < \alpha_N < \pi/2 \quad (4)$$

DIFFERENTIAL EVOLUTION TECHNIQUE APPLIED TO HEPWM

DE use mainly operational search and selection of mutations as a mechanism for directing the search towards prospective areas in the search space (Qin *et al.*, 2009). Target vector for each generation is a current population individual. Mutant vector produced after the target vector has through the mutation operation by adding the weighted difference between two chosen vectors. Trial vector is generated after the crossover operation by mixing the mutant vector with the target vector. In the next generation, the trial vector will replace the target vector, if the trial vector yields a lower objective function value than a target vector. The process repeats for each generation to reach the stopping condition (Youyun & Hongqin, 2009).

The following steps are the implementation of DE to determine the switching angles. Figure-2 shows the basic flow of the DE algorithms. Parameters for DE need to be set first; which is population size (NP), mutation factor (F), crossover rate (CR), boundary constraints and maximum generation as stopping criteria. The next steps are as follows:

(1) Initialization of the population

DE begins the optimization process by initializing the population. The initialization is expressed by:

$$x_j(i) = x_{jL} + rand_j(x_{jH} + x_{jL}) \quad (5)$$

Where $x_j(i)$ is the initial population and x_{jH} and x_{jL} are the upper and lower bound. Equation x is for j^{th} switching angle and $rand_j$ is a random number between 0 and 1.

(2) Evaluation of the initial population

The fitness value of each switching angle of the population is considered based on equation (3). The process will stop if the last value is kept when the fitness value fulfills the specified criteria or else the target vector passed to mutation process.

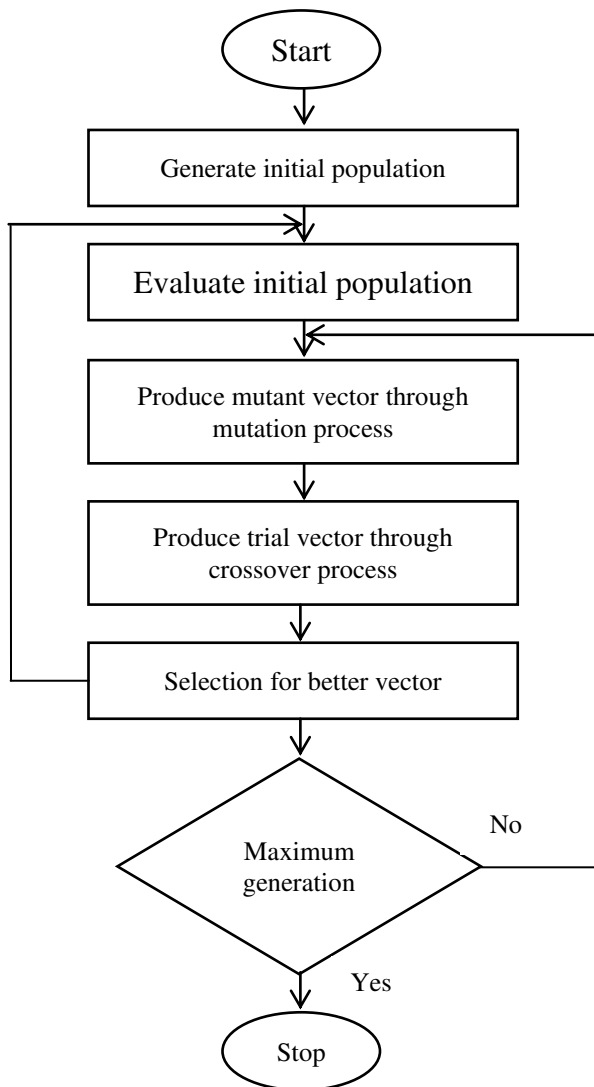

Figure-2. DE algorithm flowchart.

(3) Mutation operation

The mutation operation produces the mutant vector by perturb two random vectors in current population. Mutation factor F , which is valued between 0 and 1, controls the perturbation and improve the convergence. There are several mutation strategy described as follows:

a) DE/rand/1:

For each individual $x_{i,G}$ where $i=1,2,\dots, NP$, the perturb individual $v_{i,G+1}$ is produced by the following equation :

$$v_{i,G+1} = x_{r1,G} + F(x_{r2,G} - x_{r3,G}) \quad (6)$$

Where $r_1, r_2, r_3 \in [0, NP - 1]$, mutually different integer.

The r_1, r_2 , and r_3 are randomly chosen and different with running index i . The scale factor F is real and constant between 0 and 2, that control the amplification of the differential variation $(x_{r2,G} - x_{r3,G})$. as

randomly chosen vector and one weighted difference vector for the perturbation.

DE/best/1:

This strategy works as strategy DE/rand/1 but it uses difference equations to produce $v_{i,G+1}$ as follows:

$$v_{i,G+1} = x_{best,G} + F(x_{r2,G} - x_{r3,G}) \quad (7)$$

The best performance individual of the current population is chosen to be perturbed.

b) DE/best/2:

This strategy uses difference individual for perturbation based on the following equation:

$$v_{i,G+1} = x_{best,G} + F(x_{r1,G} + x_{r2,G} - x_{r3,G} - x_{r4,G}) \quad (8)$$

Where $r_1, r_2, r_3, r_4 \in [0, NP - 1]$, mutually different integer. The r_1, r_2, r_3 and r_4 are randomly chosen and different with running index i .

c) DE/rand-to-best/1:

This strategy uses two different individuals, which is one is the best performing individual and the other one is randomly chosen based on following:

$$v_{i,G+1} = x_{i,G} + \lambda(x_{best,G} - x_{i,G}) + F(x_{r2,G} - x_{r3,G}) \quad (9)$$

Where λ controls the greediness of this strategy. Normally $\lambda = F$ to reduce the control variable.

d) DE/rand/2:

This strategy generates $v_{i,G+1}$ using the following equation:

$$v_{i,G+1} = x_{r1,G} + F(x_{r2,G} - x_{r3,G}) + F(x_{r4,G} - x_{r5,G}) \quad (10)$$

Where $r_1, r_2, r_3, r_4, r_5 \in [0, NP - 1]$, mutually different integer. The r_1, r_2, r_3, r_4 and r_5 are randomly chosen and different with running index i .

(4) Crossover operation

The crossover process produces the trial vector by mixing the mutant vector with the target vector based on following:

$$u_{j,i,G+1} = \begin{cases} v_{j,i,G+1}, & \text{if } rand \ll CR \text{ or } i = k \\ x_{j,i,G+1}, & \text{otherwise} \end{cases} \quad (11)$$

The crossover rate CR value in range 0 and 1 and it control the crossover process. $rand$ is the value within 0 and 1, and j is the element value of i th vector that through the crossover process.

(5) Selection operation

A selection process is executed after the evaluation of the objective function of the trial vector is done. The value of the objective function of the trial vector



is compared to the target vector to determine the vector that will be carried to the next generation. The trial vector will be included in the population for the next generation if the value of the objective function of trial vector is less or equal to the target vector. If not, the target vector stays in the population for the next generation. The selection process can expressed as follows:

$$x_{i,G+1} = \begin{cases} u_{i,G+1}, & \text{if } J(u_{i,G+1}) < J(x_{i,G}) \\ x_{i,G}, & \text{otherwise} \end{cases}$$

$$i = 1,2,3, \dots, NP \tag{12}$$

J is the fitness evaluation function. The above process is repeated to produce a new next generation until met the stopping criteria (Youyun and Hongqin, 2009), (Storn, 1996), (Qin *et al.*, 2009).

SIMULATION RESULT

The mutation strategies give out the similar switching angle trajectories for all strategy. The difference output from the strategies is the computational time by each strategy. Even though the time taken for each strategy has small difference, its influence grows bigger as the number of harmonics to be eliminated increase. The strategy that suit most is DE/best/2 and DE/rand/1. The DE parameter is set as follows; the mutation factor, $F = 0.4$, crossover probability, $CR = 0.5$, harmonic tolerance, $VTR = 0.00001$ and the maximum generation, $G_{max} = 400$, to carry the comparison of the two strategies.

Table-1. Computational time for two strategies for N=3, 5, 7.

N	Computational time (s)	
	DE/best/2	DE/rand/1
3	0.43260	0.42574
5	0.66762	0.61690
7	0.72506	0.70738

From the Table-1, DE/rand/1 has the fastest computational time compare to DE/best/2. Matlab/Simulink is used for programming the DE algorithm. Figure-3 shows the switching angle trajectories versus modulation indices for DE/best/2 and DE/rand/1 strategies. Both strategies give same switching angle trajectories, but have different computational time. Figure-4 shows the switching angle trajectories versus modulation indices for $N=5, 7, 9$ and 13 . Numbers of lines represent the value of N. Amount of line increase as N increase. The computational also increases as N increase.

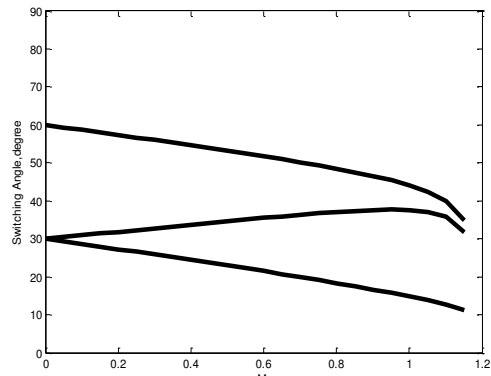

(i)

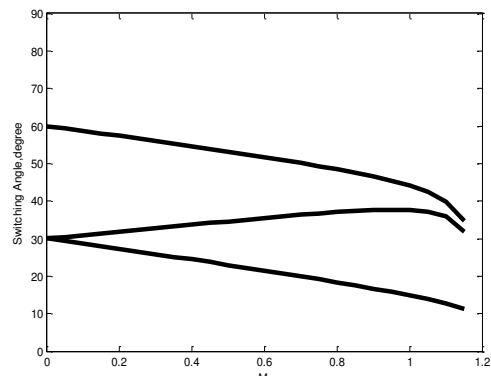

(ii)

Figure-3. Switching angle trajectories versus modulation indices for N=3 using (i) DE/best/2 strategy, (ii) DE/rand/1 strategy.

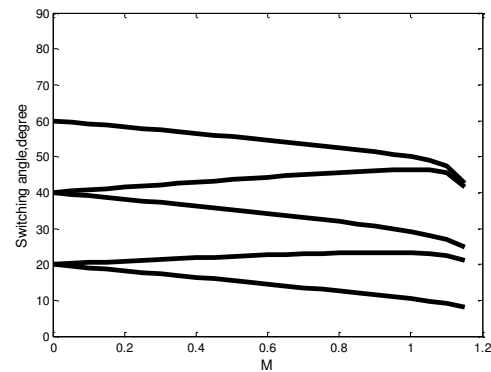

(a)

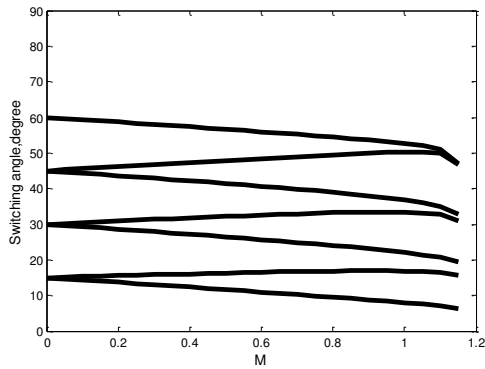

(b)

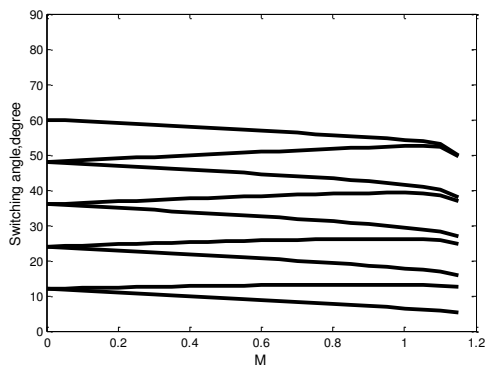

(c)

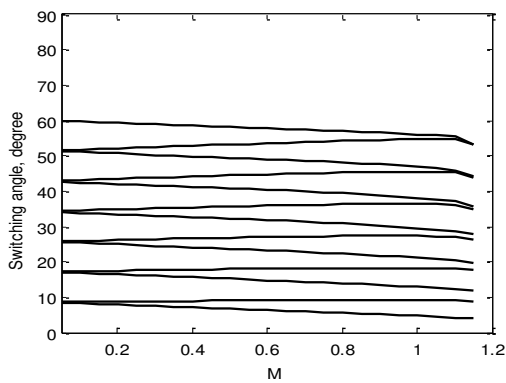

(d)

Figure-4. Switching angle trajectories versus modulation indices for
 (a) $N=5$, (b) $N=7$, (c) $N=9$, (d) $N=13$.

The switching angle obtained will be stored in memory and when needed for inverter they are called out. Figure-5 shows the experiment set up in Matlab/Simulink. Switching angle produce using differential evolution was then generated the pulses for inverter. The parameters of the inverter are $V_{dc}=200$, frequency=50Hz and load is 4.5mH/0.12Ω.

Figure-6 shows the line to line output voltage of the inverter after applying the switching angle from DE and Figure-7 shows line to neutral output voltage for $N=13$ and $M=0.85$.

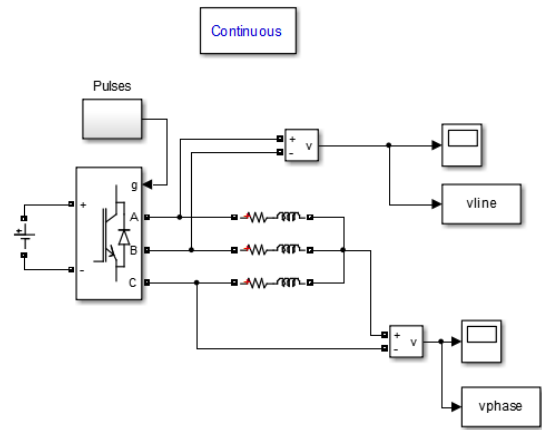

Figure-5. Experiment set up in Matlab/Simulink.

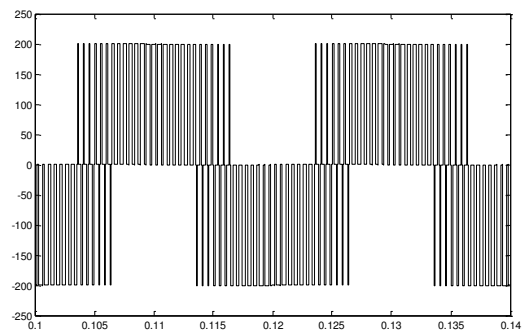

Figure-6. Line to line output voltage.

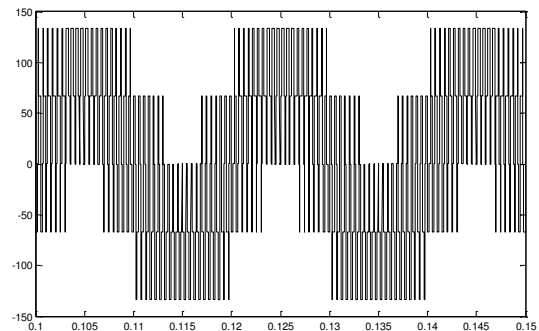

Figure-7. Line to neutral output voltage.

Figure-8 shows the spectrum for line to line voltage and Figure-9 shows the spectrum for line to neutral voltage for $N=13$. Both spectra eliminated harmonics until 37th harmonic.

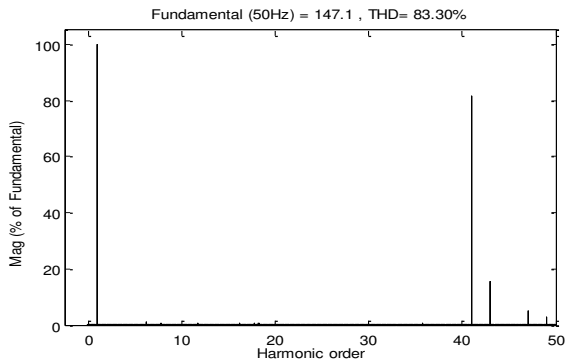
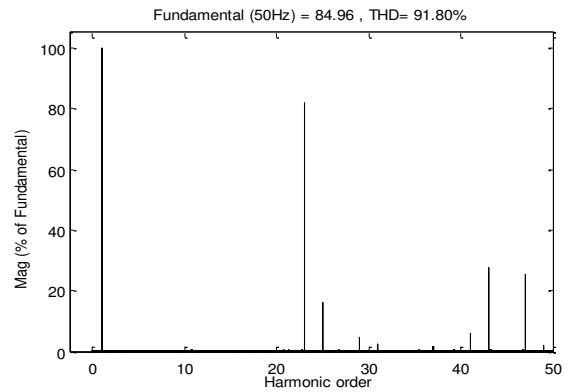

Figure-8. Spectrum of line to line output voltage for N=13.



(b)

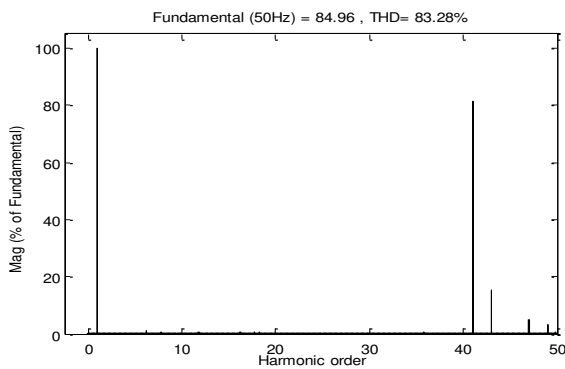
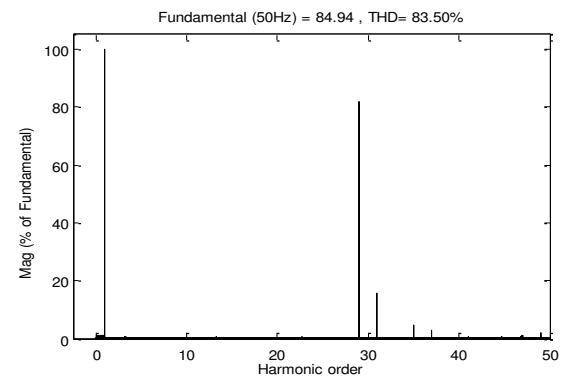

Figure-9. Spectrum of line to phase output voltage for N=13.



(c)

Figure-10. Spectrum of line to neutral output voltage for (a) N=5 (b) N=7 (c) N=9.

Figure-10 shows the spectrum for output voltage line to neutral for $N=5, 7, 9$. Number of harmonic eliminated as expected based on N .

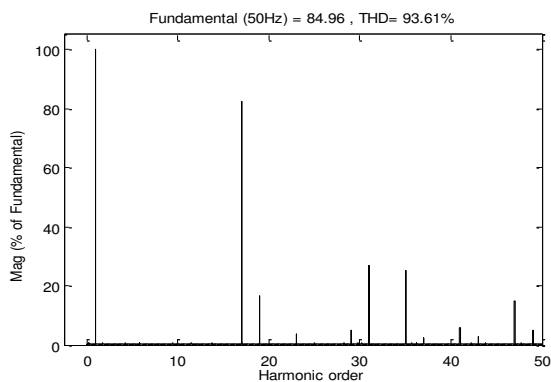

(a)

CONCLUSIONS

This paper presents the Differential Evolution (DE) algorithm for calculating the HEPWM switching angles. The DE technique is proposed and the best approach of mutation strategy has been analyzed. The proposed DE algorithm calculates the switching angles and stored the angle values in memory. The switching angles are then called upon when required to operate the three-phase inverter. The inverter output voltages and their harmonic spectrum waveforms have been presented in this paper. The number of eliminated harmonic components will increase as the number of switching angles is increased. As a result, the Total Harmonic Distortion (THD) of output voltage will reduce which improve the inverter performance. The calculation and simulation of the proposed DE algorithm applied to the three phase inverter have been performed by using Matlab/Simulink software package.

ACKNOWLEDGEMENT

The authors would like to thank the Universiti Teknikal Malaysia Melaka and the Ministry of Education of Malaysia for the financial support in order to carry out the research project. The project was managed by the Centre for Research and Innovation Management,



Universiti Teknikal Malaysia Melaka under Vot. Number S1307.

REFERENCES

Amjad, A. M., Salam, Z. and Saif, A. M. A. 2015. Application of differential evolution for cascaded multilevel VSI with harmonics elimination PWM switching. *International Journal of Electrical Power & Energy Systems*, 64(0), 447-456.

Bahari, N., Salam, Z. and Taufik. 2010, 7-10 Nov. 2010. Application of Differential Evolution to determine the HEPWM angles of a three phase voltage source inverter. Paper presented at the IECON 2010 - 36th Annual Conferences on IEEE Industrial Electronics Society.

Debnath, S. and Ray, R. N. 2012, 1-2 March 2012. Harmonic elimination in multilevel inverter using GA and PSO: A comparison. Paper presented at the Electrical, Electronics and Computer Science (SCEECS), 2012 IEEE Students' Conference on.

Moeed Amjad, A. and Salam, Z. 2014. A review of soft computing methods for harmonics elimination PWM for inverters in renewable energy conversion systems. *Renewable and Sustainable Energy Reviews*, 33(0), 141-153.

Mohd Rashid, M. I., Hiendro, A. and Anwari, M. 2012, 2-5 Dec. 2012. Optimal HE-PWM inverter switching patterns using differential evolution algorithm. Paper presented at the Power and Energy (PECon), 2012 IEEE International Conference on.

Patel, H. S. and Hoft, R. G. 1973. Generalized Techniques of Harmonic Elimination and Voltage Control in Thyristor Inverters: Part I--Harmonic Elimination. *Industry Applications*, IEEE Transactions on, IA-9(3), 310-317. doi: 10.1109/TIA.1973.349908.

Patel, H. S. and Hoft, R. G. 1974. Generalized Techniques of Harmonic Elimination and Voltage Control in Thyristor Inverters: Part II - Voltage Control Techniques. *Industry Applications*, IEEE Transactions on, IA-10(5), 666-673. doi: 10.1109/TIA.1974.349239.

Qin, A. K., Huang, V. L. and Suganthan, P. N. 2009. Differential Evolution Algorithm with Strategy Adaptation for Global Numerical Optimization. *Evolutionary Computation*, IEEE Transactions on, 13(2), 398-417. doi: 10.1109/TEVC.2008.927706.

Storn, R. 1996, 19-22 Jun 1996. On the usage of differential evolution for function optimization. Paper presented at the Fuzzy Information Processing Society, 1996. NAFIPS., 1996 Biennial Conference of the North American.

Tsornng-Juu, L., O'Connell, R. M. and Hoft, R. G. 1997. Inverter harmonic reduction using Walsh function harmonic elimination method. *Power Electronics, IEEE Transactions on*, 12(6), 971-982. doi: 10.1109/63.641495.

Youyun, A. and Hongqin, C. 2009, 19-21 May 2009. Experimental Study on Differential Evolution Strategies. Paper presented at the Intelligent Systems, 2009. GCIS '09. WRI Global Congress on.