

Design of compact ultra wideband antenna for microwave medical imaging application

A. Othman¹, N. I. S. Shaari², A. M. Zobilah³, N. A. Shairi⁴, Z. Zakaria⁵

^{1,2}Fakulti Teknologi Kejuruteraan Elektrik dan Elektronik (FTKEE),
Universiti Teknikal Malaysia Melaka (UTeM), Malaysia

^{3,4,5}Fakulti Kejuruteraan Elektronik dan Kejuruteraan Komputer (FKEKK),
Universiti Teknikal Malaysia Melaka (UTeM), Malaysia

Article Info

Article history:

Received Jan 16, 2019

Revised Mar 1, 2019

Accepted Apr 11, 2019

Keywords:

Antenna

Defected ground structure
(DGS)

H-Slot

Ultra wideband (UWB)

ABSTRACT

A compact ultra wideband (UWB) antenna for operation at 6 GHz intended for microwave medical imaging (MMI) application is proposed. The microstrip patch antenna (MPA) was design in hexagon shape which contain H-slot at the centre top of the patch and a slot at the ground. Those slots method is utilised to enhance the operating bandwidth as well as minimising the antenna's impedance mismatch caused by its proximity to material. Results shows that, the implementation of slot on the patch has profoundly enhance the bandwidth (BW) of the antenna to 503.54 MHz. Measurement of fabricated antenna produce significant result in term of producing wide bandwidth of 520 MHz, with slightly shifting on operating frequency. Therefore, it has been proved that the required performance of UWB antenna has been achieved successfully.

*Copyright © 2019 Institute of Advanced Engineering and Science.
All rights reserved.*

Corresponding Author:

A. Othman,

Fakulti Teknologi Kejuruteraan Elektrik dan Elektronik (FTKEE),

Universiti Teknikal Malaysia Melaka (UTeM),

Hang Tuah Jaya, 76100, Durian Tunggal, Melaka, Malaysia.

Email: adib@utem.edu.my

1. INTRODUCTION

Microwave imaging technique has been extensively investigated and utilized for difference applications. There are include for example, the detection of invisible of objects such as steel rebars or dowel and even detection of breast cancer cells [1, 2]. The ultra wideband (UWB) antenna is high in gain, wide bandwidth, compact in structure and consumption of power is less compared to other microwave frequency bands [3, 4]. Among various possible antenna, the UWB microstrip antenna design is chosen due to low operating power, good noise immunity, compact in size and potentially very high data rates if its operates at high frequency. Therefore, it is really suitable for medical application which needs fast and reliable output results of patience health and status [4, 5].

However, they suffer from a very narrow bandwidth which is a function of the substrate thickness and dielectric constant [6, 7]. Although increasing substrate thickness technically can improve the antenna bandwidth, it will lead to mismatch of impedance associated with the feed junction [8].

Many methods have been investigated to improve the bandwidth of microstrip antenna. Stack configuration are able to improve the bandwidth up to 20% [9 - 11]. However, the complexity of hardware fabrication will lead to unnecessary results if not been done carefully. The bandwidth of the antenna also depends on patch shape and structure [12, 13]. Therefore, this paper will be focusing on introduction of slot and defected ground structure (DGS) on microstrip patch antenna (MPA) to meet the required wide bandwidth.

2. ANTENNA DESIGN AND FABRICATION

The proposed antenna consists of a ground plane, FR-4 substrate, radiating patch and microstrip inset feed. Figure 1 shows the top view and meanwhile Figure 2 shows the back view of the antenna.

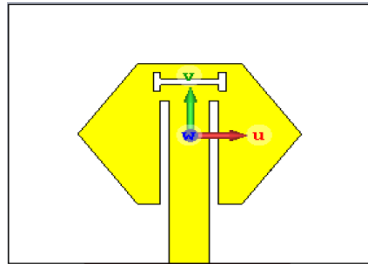

Figure 1. Front view of proposed UWB antenna

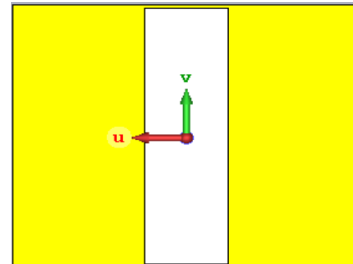

Figure 2. Back view of proposed UWB antenna

Several dimension optimization of the proposed antenna designed has been done in order to meet the resonance frequency, return loss, bandwidth and gain requirements. The final dimensions of the designed antenna are shown in Table 1.

Table 1. List of Optimize Antenna Dimensions

Description	Dimensions (mm)
Patch length	11.45
Patch width	15.35
Patch thickness	0.035
Microstrip feed line length	10.525
Microstrip feed line width	2.76
Substrate height	21.05
Substrate width	24.95
Substrate thickness	1.6
Ground length	21.05
Ground width	24.95
Ground thickness	0.035

The patch was designed in hexagon shape which contain the H-slot. The slot has improved the impedance matching of the patch as well as making the operating frequency of the antenna nearer to 6 GHz. Furthermore, the antenna bandwidth also increases due to the introduction of the H-slot on the patch. Figure 3 shows the H-slot dimensions.

There is also a slot been introduced on the ground side. Usually any structure that been introduced at the ground plane is also known as defected ground structure (DGS). The DGS method is used to isolate the undesired electromagnetic radiation from the antenna towards its surroundings. Figure 4 shows the DGS dimensions.

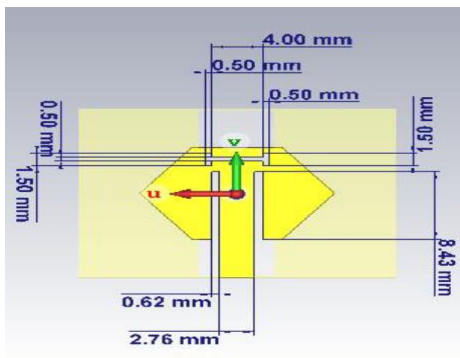

Figure 3. H-slot dimensions on the patch

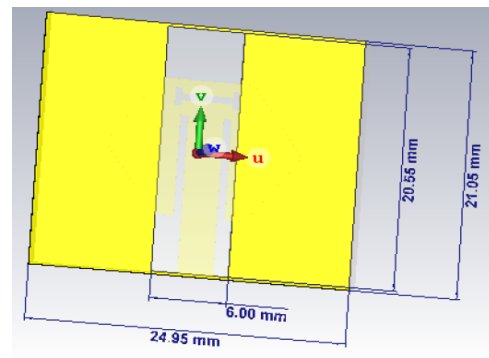

Figure 4. DSG dimensions on the ground

Figure 5 shows the top view and meanwhile Figure 6 shows the back view of the fabricated antenna. The antenna is well fabricated with the exact dimensions of H-slot and DGS structure from the designed. The antenna was fabricated on the FR4 substrate with a thickness of 1.6 mm, relative permittivity of 4.4, and loss tangent of 0.02. The material of radiating element and ground plane is copper with the thickness of 0.035 mm.



Figure 5. Front view of fabricated UWB antenna

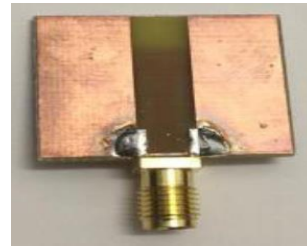

Figure 6. Back view of fabricated UWB antenna

3. RESULTS AND ANALYSIS

3.1. Simulation

Figure 7 shows return loss of the simulated antenna. The return loss value is -18.58 dB which resonance at 6.08 GHz. The return loss value is less than -10 dB and hence indicate proper impedance matching between the feed and the patch.

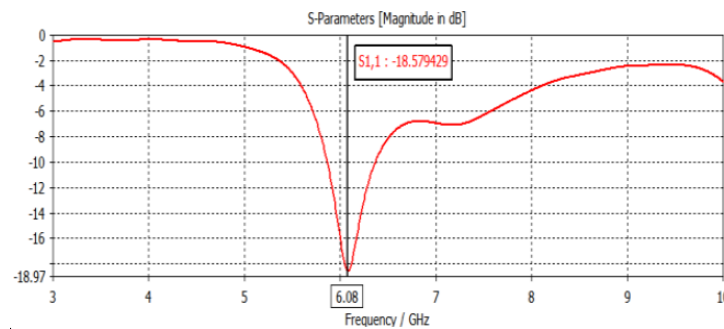

Figure 7. Return loss of simulated antenna

Figure 8 shows the bandwidth of the simulated antenna. The bandwidth value is 503 MHz from lower cut-off frequency of 5.86 GHz to upper cut-off frequency of 6.37 GHz. As define in [14, 15], bandwidth of UWB antenna must be equal to or greater than 500MHz, regardless of the fractional bandwidth. Therefore, the designed antenna is UWB antenna as the bandwidth value concerned.

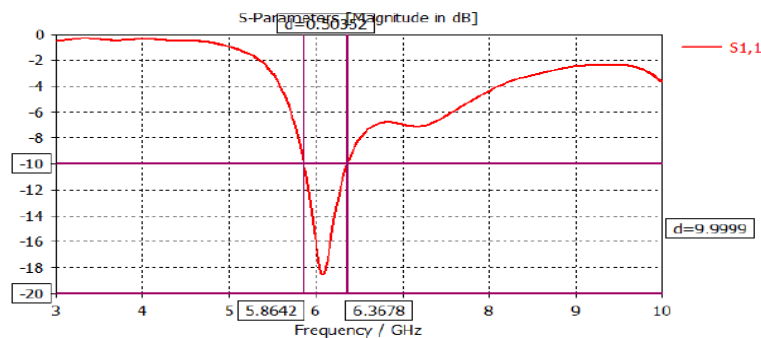

Figure 8. Bandwidth of simulated antenna

Figure 9 shows the radiation pattern of the simulated antenna. The radiation pattern shows that the antenna is directional antenna with strongest radiation on top of the patch. Therefore, it is proved that the patch has worked as radiating element on the antenna.

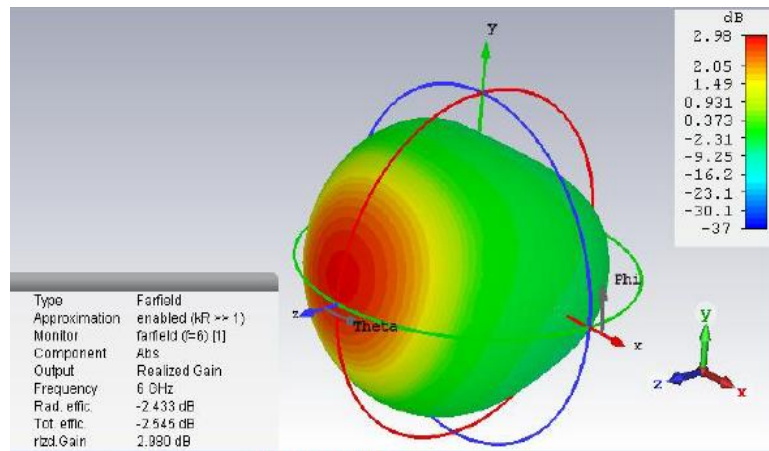

Figure 9. Radiation pattern of simulated antenna

Figure 9 also shows that the gain value is 2.98 dB. The gain results show that the antenna is able to transmit microwave with increase of power. Meanwhile, the antenna efficiency is -2.545 dB or 55.65%. This means that approximately half of input power is radiated as microwave. Eventhough half of the input power radiated, the radiated power been further increase by the gain factor as stated.

3.2. Measurement

Figure 10 shows the result of return loss from the measurement on Network Analyzer. The return loss of the fabricated antenna is 19.56 dB which resonance at 6.11 GHz. Both measurement and simulation results show agreement on return loss value eventhough there is a slight shifting in resonance frequency.

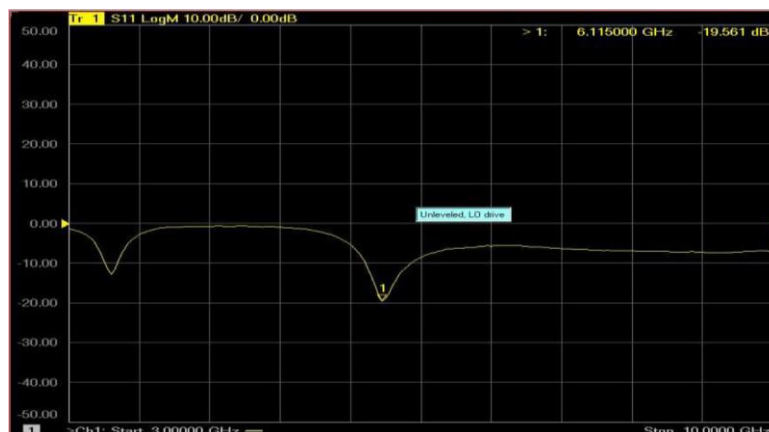

Figure 10. Return loss of fabricated antenna

As for bandwidth, the value for fabricated antenna is 520 MHz which almost the same to simulated result. Therefore, the result agrees with the bandwidth of UWB antenna definition.

Figure 11 shows the radiation pattern from the measurement in anechoic chamber. The fabricated UWB antenna (antenna under test) were rotated using the antenna's positioning system for 360° to obtain results as in Figure 11. The result agrees with the simulated antenna whereby both results show that the antenna is directional on top of the patch.

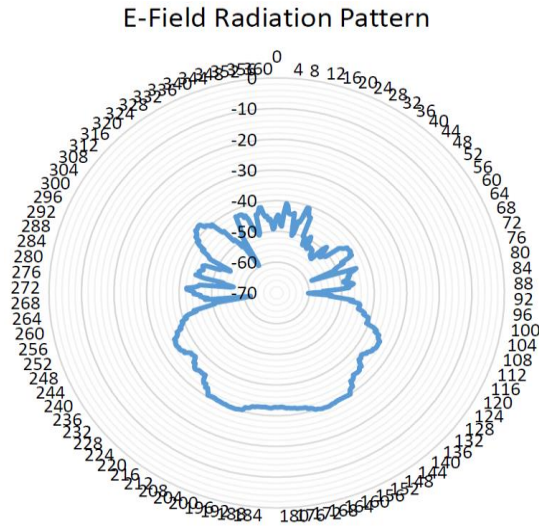

Figure 11. Radiation pattern of simulated antenna

In order to obtain the gain of fabricated antenna, mathematical equation (in dB) as in (1) has been used whereas P_r is power at the receiving antenna, P_t is output power of transmitting antenna, G_t is gain of transmitting antenna, G_r is gain of receiving antenna, P_c is power of cable loss and P_a is power loss during microwave free space propagation from transmitter to receiver.

$$P_r = P_t + G_t + G_r - P_c - P_a \tag{1}$$

Power received by the antenna under test, P_r is measured at 34.636 dBm. Referring to data sheet of transmitting antenna and connecting cable on receiving antenna, therefore the gain of the antenna under test, G_r can be calculated. The calculation show that the G_r value is 2.304 dB. This result agrees with the gain of simulated antenna although its differ slightly. As the gain factor concern, the fabricated antenna can still function as microwave radiator with this slight difference. As summarization, Table 2 shows the comparison between the simulation and measurement results of the UWB microstrip patch antenna.

Table 2. Comparison of Simulation and Measurement Results

Parameter (unit)	Simulation	Measurement
Frequency (GHz)	6.08	6.11
Gain (dB)	2.98	2.304
Return Loss (dB)	-18.58	-19.56
Bandwidth (MHz)	503	520

4. CONCLUSION

The result analysis and discussion of the simulation and measurement results of the proposed antenna for UWB microstrip patch antenna is presented. The performance of UWB microstrip patch antenna is also proven, as the return loss of the antenna are less than -10 dB, which considered as good antenna. A good agreement between the simulation and the measurement result are obtained. Result of gain, bandwidth and resonance frequency of fabricated antenna is also agree with the simulation results with slightly different in value. As far as the results concern, the UWB microstrip patch antenna is suitable in microwave medical imaging application.

ACKNOWLEDGEMENTS

The authors would like to greatly express their thanks and appreciation to the Centre for Research and Innovation Management (CRIM) and Universiti Teknikal Malaysia Melaka (UTeM) for their encouragement, help and financially supporting to complete this research work. The publication of this paper was funded by the Short Term Research Grant under the research grant No. PJP/2018/FTK(A1)/S01617.

REFERENCES

- [1] M. Moosazadeh and S. Kharkovsky, "Design of Ultra-Wideband Antipodal Vivaldi Antenna for Microwave Imaging Applications", 2015 IEEE International Conference on Ubiquitous Wireless Broadband (ICUWB), Montreal, QC, 2015, pp. 1-4.
- [2] H.A. Nugroho, H.K.N. Yusufiyah, T.B. Adji, W.K.Z Oktoeberza, "Shape Analysis for Classification of Breast Nodules on Digital Ultrasound Images", *Indonesian Journal of Electrical Engineering and Computer Science*, vol. 13, no. 2, pp. 837-844, Feb. 2019.
- [3] J. Ali, N. Abdullah, R. Yahya, E. Mohd, A. Joret, N. Katiran, "Bistatic Configurational Analysis of Ultra-Wideband Antenna for Detection Applications", *Indonesian Journal of Electrical Engineering and Computer Science*, vol. 13, no. 2, pp. 702-707, Feb. 2019.
- [4] I.D. Saiful Bahri, Z. Zakaria, N. A. Shairi, N. Edward, "A Novel UWB Reconfigurable Filtering Antenna Design with Triple Band-Notched Characteristics bu Using U-Shaped Coppers", *Indonesian Journal of Electrical Engineering and Computer Science*, vol. 14, no. 1, pp. 267-275, Apr. 2019.
- [5] G. Conway, W. Scanlon, "Antennas for over Body-Surface Comm. At 2.45 GHz", *IEEE Trans. Antennas Propagat.*, vol. 57, no. 4, pp. 844-855, Apr. 2009.
- [6] H. R. Raad, A. I. Abbosh, H. M. Al-Rizzo and D. G. Rucker, "Flexible and Compact AMC Based Antenna for Telemedicine Applications," in *IEEE Transactions on Antennas and Propagation*, vol. 61, no. 2, pp. 524-531, Feb. 2013.
- [7] Yadav, S., Gautam, A.K. and Kanaujia, B.K., "Design of dual band-notched lamp-shaped antenna with UWB characteristics", *International Journal of Microwave and Wireless Technologies*, pp.1-8, 2015.
- [8] M. K. A. Rahim and P. Gardner, "The design of nine element quasi microstrip log periodic antenna," 2004 RF and Microwave Conference (IEEE Cat. No.04EX924), Selangor, Malaysia, 2004, pp. 132-135.
- [9] M. K. A. Rahim and P. Gardner, "Microstrip log periodic antenna (LPA) using inset feed," 2004 10th International Symposium on Antenna Technology and Applied Electromagnetics and URSI Conference, Ottawa, Canada, 2004, pp. 1-4.
- [10] M. N. Shakib, M. T. Islam, and N. Misran, "Stacked Patch Antenna with Folded Patch Feed for Ultra-wideband Application", *IET Microwaves, Antennas & Propagation*, vol. 4, pp. 1456-1461, 2010.
- [11] R.A. Pandhare, P.L. Zade, and M.P. Abegaonkar, "Miniaturized microstrip antenna array using defected ground structure with enhanced performance," *Engineering Science and Technology, an International Journal*, vol. 19, pp. 1360-1367, Apr. 2016.
- [12] D. Sharma and R. Kumar, "Design and analysis of five element microstrip log-periodic antenna," 2010 International Conference on Applications of Electromagnetism and Student Innovation Competition Awards (AEM2C), Taipei, 2010, pp. 210-214.
- [13] D. Valderas, X. Chen, C. Ling, J. I. Sancho, and D. Puente, *Ultrawideband antennas: Design and applications*, London: Imperial College Press, 2010, pp. 1-13.
- [14] US Federal Communications Commission (FCC), Part 15, October 2003, <http://www.fcc.gov/oet/info/rules>.
- [15] F. Sabath, E. L. Mokole and S. N. Samaddar, "Definiton and classification of Ultra-Wideband signals and devices," *The Radio Science Bulletin*, 2005, no. 313, pp. 12-26.