

Evaluation Study an Automatic Capture of Glucose level by using Glucose Sensor for Collecting Vital Sign Data

A. K. R. A. Jaya¹, A. M. Kassim², S. Syahid¹ and A. H. Azahar²

¹*Auro Technologies PLT, No 76, Jalan TU 42, 75450 Ayer Keroh, Melaka*

²*Center of Robotics and Industrial Automation (CeRIA), Universiti Teknikal Malaysia Melaka, Hang Tuah Jaya, 76100 Durian Tunggal, Melaka.*

Email: biak_ro@yahoo.com

Abstract—Nowadays, a lot of medical equipment has been integrated with the electronic device to make medical equipment more users friendly. In this project, a device using a glucose sensor to automatically capture the biological data is developed to help the doctor to follow up the patient health information. The traditional medical equipment is to take the reading such as blood pressure, blood glucose level, temperature, and etc. manually. Normally the traditional method will have many errors occur while taking the reading like parallax error or human error. Other than that, the traditional method also consumes a lot of time when taking biological data. In this project, an innovative device is designed and developed to take the biological data in automatic way to replace the manual traditional method of taking the glucose tests. The integrated device is expected to be designed to collect the blood glucose data from the designed blood glucose measuring mechanism, that is attached on a medical checkup chair and consequently integrate them into the personal medical database that can be transmitted through a USB device to a server. The traditional method consumes too much time from collecting sample until recording data into computer and human error may occurs during data recording. Hence, time consuming is lessening and faster action can be done by nurse and medical doctor while observing the patient current health information in order to provide the most suitable treatment for the patient from time to time.

Keywords—*glucose sensor, integrated medical healthcare system, glucose level.*

I. INTRODUCTION

For acute patients, it is normal to be sent into hospital ward. However, there are many other patients inside the ward, and when the nurse captures blood glucose and others, this process will consume a lot of time. It causes the ward overcrowding. The treatment in the hospital is relatively high due to the equipment used in the hospital and the consultation from the doctor and nurse. This is not includes the other cost like transport, meal, and accommodation for the patient and their family member. This project will help to reduce the additional cost to go to the hospital when they are having treatment.

The ratio of registered nurses to population in Malaysia is 1:333. On the other hand, the ratio of community nurses to population shown very high remarks at 1:1,487. It shows that the number of nurse in Malaysia is not enough to handle a big number of patient in the hospital. Hence, this project is important to be developed to overcome the shortage of nursing in Malaysia [1].

In addition, high blood glucose level will cause serious disease which is diabetes. From National Diabetes Institute (NADI) survey, Malaysian has shown a prevalence of diabetes among rural and semi-urban populations of 14.0% (range 7.1% to 20.3%) in 1998. NADI have stated that the current prevalence has raised to 18% in just 6 years. Assuming just 40% of the

population estimated at 25 million are 30 years and above, we should have at least 1.6 million adult diabetics in this country. Considering the statistic of recent years, it will be even more critical [2]-[3].

Conventionally, the invasive blood glucose method required to draw the blood sample to measure the blood glucose level of a person. The blood glucose test can be done by drawing a drop of blood and place on the test strip. Then, the test strip will insert it into the glucose meter. The blood will have a chemical reaction with the test strip and create ferrocyanide. Then, the test strip that has been inserted into the glucose meter and produces electric current flow from the test strip to the glucose meter. The electric current is measured and the strength of the electric current depends on the glucose level of the blood. The glucose meter will convert the electric current into digital value and display on the screen of the glucose meter [4].

Mendelson et al. have proposed a non-invasive blood glucose measurement by using infrared radiation to lighten the burden on the diabetic. This technique is using the phenomena that the molecule has a specific resonance absorption peak. The molecule will vibrate and rotate oscillate cause peak. There is a large amount of infrared (IR) absorption peak that often overlap. The infrared spectrum of glucose and the magnitude of absorption peak directly related to glucose concentration. The IR absorption intensity calculated by using Beer-Lambert's Law. Hence, the glucose concentration can be measured [5]-[6].

Paul et al. also proposed the measurement technique by using the fundamental of light and the refraction theory. Glucose will decrease the refractive index because it will scatter the light between glucose and the surrounding media. It will cause the scattering coefficient to become lower and the optical path becomes shorter. By using the PPG (photoplethysmography) method, the glucose level in the sample can be measured [7]-[8]. Patel et al. also proposed the method to measure the human blood glucose level by collecting the human tear using contact lenses. This method is using the theory of electro-enzymatic by using a gold electrode

on the glass substrate. The glucose level is measured according to the electric current produce when there are electrolysis occurred. The output of electric current is very small which are about 180nA to 320nA. The glucose level will be calculated base on the strength of the electric current. This method is suitable for day-long blood glucose monitoring [9]-[10].

Hence, an innovative device will be designed and developed to take the biological data automatically which replace the traditional method of taking the glucose tests manually. The integrated device is expected to be designed for collecting the blood glucose data from the designed blood glucose measuring mechanism that is attached on a medical checkup chair and consequently integrate them into the personal medical database that can be transmitted through a USB device to a server. The traditional method consumes too much time from collecting sample until recording the data into the computer and human error may be occurring during recording the data. Hence, less time consume and fast action can be made by a nurse and medical doctor to observe the patient current health information in order to provide the most suitable treatment for the patient from time to time.

II. HARDWARE CONFIGURATION

A. System description

The project hardware is constructed based on the designed mechanism and circuit. The hardware consists of power supply to power up the amplification circuit. Test strip insertion part is designed to fit the test strip when measuring the blood glucose. The complete project hardware is shown in Fig. 1. In order to start the blood glucose measurement, a new blood glucose test strip needs to use to measure blood glucose level and need to change every time to start a new measurement. A lancet is required to withdraw the blood drop for measurement purpose. The blood drop will be placed on the test strip to start the test and there will have a chemical reaction between the enzyme of a test strip and glucose to produce a small current. The output current will go through the Arduino controller and process the signal with the ADC

module. The block diagram for the mechanism of the project is illustrated in Fig. 2. One switch is needed to start the device. Once the user places the test strip on the test strip insertion part, a small voltage will be produced and amplify the small signal by using the instrumentation amplifier into a readable voltage for the Arduino controller. After amplify the voltage, the signal will be processed by ADC and Arduino for calculating the blood glucose level by using an algorithm calculation.

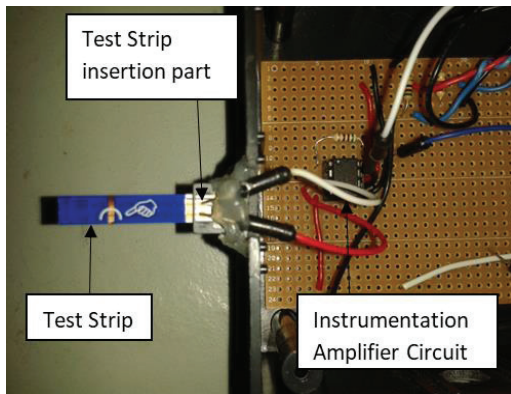

Fig. 1. Project hardware connected to computer via USB

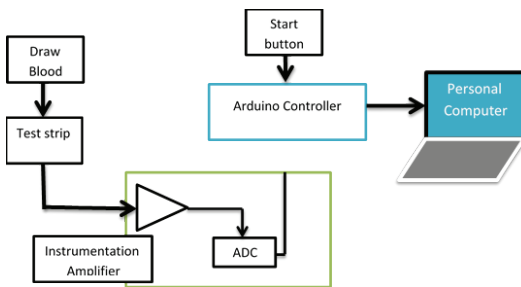

Fig. 2. Blood glucose measurement mechanism

B. Blood glucose test strip

The blood glucose test strip is used to convert the blood glucose into a small electric current. The electric current produced by oxidation of blood glucose with the enzyme inside the test strip. The test strip has two electrodes which are working electrode (WE) and the reference electrode (RE) which acts as a positive terminal and negative terminal respectively. The layer of the enzyme will react with glucose, oxygen, and hydrogen peroxide. Electric current is produced between the electrodes during electrolysis

reactions occur. In mechanism design, the test strip should not expose to the air before taking blood glucose measurement. This is because the test strip will have a chemical reaction with oxygen. The formula is shown in Eq. 1 is the chemical formula for blood glucose test strip. To measure the voltage produced by the test strip, the voltage difference can be measured between the working electrode and a reference electrode. The voltage produced is in mV and μA which is very sensitive. In order to have higher accuracy, the circuit design should be low in noise and avoid using the long wiring connection [11]-[12].

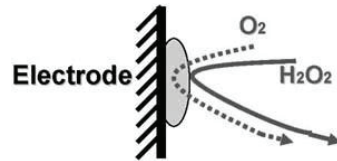
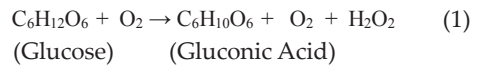

Fig. 3. Blood glucose test strip chemical reaction

C. Instrumentation amplifier

The instrumentation amplifier is used to amplify the voltage from the test strip. This is because the voltage produced from the test strip is in mV, which is impossible for Arduino to read the extremely small voltage. Therefore, an instrumentation amplifier by using INA 114 is required to amplify the voltage to a readable voltage for Arduino. Since the voltage from the test strip is in mV, so the voltage needs to amplify 100 times to get the desired voltage for Arduino. The gain formula for INA 114 provides in the datasheet is shown as Eq. 2.

$$G=1+ 50 \text{ k}\Omega / R_g \quad (2)$$

A resistor needed to change the gain value. In this case, a 50k ohm resistor is used to adjust the gain to approximately 100 times in order to be readable by ADC module in Arduino.

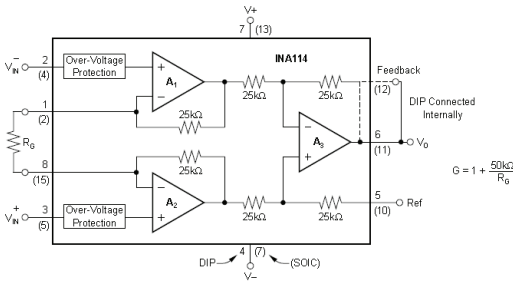

Fig. 4. Instrumentation amplifier INA114 circuit diagram

D. Project circuit diagram

The circuit has been designed and simulates by using Proteus software to test the functionality. In order to prevent the component from damage, a software simulation needs to be done to confirm the connectivity of the circuit is correct. In this case, Arduino is represented by another controller since it, not in Proteus library as well as the test strip. External power supply needed to power up the amplifier, negative power supply needs to provide to the amplifier. The blood glucose test strip has two terminals which are working electrode and reference electrode. These two terminals will connect to the amplifier’s Vin- and Vin+ pin. A push button connects to Arduino digital pin 6 and the output from the amplifier connect to analog pin 0 of Arduino.

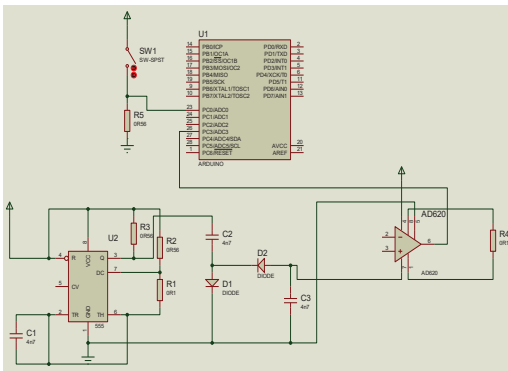

Fig. 5. Circuit diagram simulation

E. Blood glucose calculation method

Since the Arduino controller that we used is 10 bits controller with 1024 step, each step size is 4.88mV when Vref is 5V which is shown in Eq. 3.

$$\text{Step size} = 5V / 1024 \quad (3)$$

Therefore, a set of blood glucose data need to be collected in order to calculate the actual blood glucose level. Since there is no datasheet for the test strip, the experiment was done to collect data for comparing the voltage output and the glucose level. Ten blood samples are taken from different people to observe the relationship between voltage and blood glucose level. From the data collected, a graph will be plotted to formulate the relationship between voltage level and blood glucose level. The graph plotted is in a linear shape, linear line formula can be used to calculate the actual blood glucose level. Table 1 and Fig. 6 show the result of the relationship between blood glucose level and voltage level.

TABLE 1: RELATIONSHIP BETWEEN BLOOD GLUCOSE LEVEL AND VOLTAGE AFTER AMPLIFY WITH INSTRUMENTATION AMPLIFIER INA 114

Blood sample no.	Voltage/V	Glucose level mmol/L
1	2.18	3.9
2	2.26	4.3
3	2.31	4.5
4	2.32	4.6
5	2.33	4.6
6	2.38	4.7
7	2.4	5.3
8	2.49	5.6
9	2.54	6.4
10	2.61	7.1

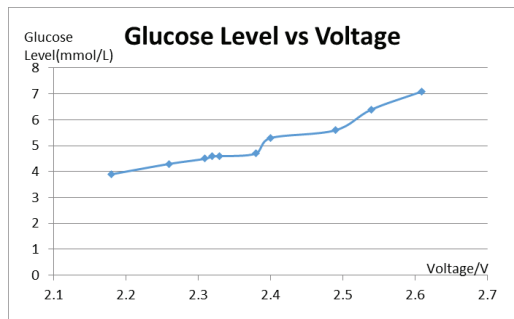

Fig. 6. Relationship between blood glucose level and voltage using INA 114

From Fig.1, the voltage level is increased proportionally with the blood glucose level. The calculation of voltage level difference and glucose level difference can be shown as follows.

Voltage difference = $2.61V - 2.18 = 0.43V$
 Glucose level difference = $7.1\text{mmol/L} - 3.9\text{mmol/L}$
 $= 3.2\text{mmol/L}$

Therefore, the increment of $0.1V$ in voltage level will increase 0.75mmol/L of blood glucose level according to the graph. Output voltage level can be calculated by using the formula shown in Eq. 4.

$$\text{Output voltage} = (\text{Analog read} * 5V) / 1024 \quad (4)$$

Analog reading is a step value read from the analog pin which connect to the test strip output. From the graph, the voltage did not start from zero so to adjust the glucose reading 1.7 need to be added to adjust the glucose level calculation more accurately. The reason 1.7 is added to into the calculation is when the glucose level is 3.9 mmol/L which voltage is $2.18V$. This value is used as a reference point which the difference between the glucose level and voltage is 1.72 . So the voltage value needs to add 1.72 and convert the voltage value to the blood glucose level in mmol/L . After the reference point, increasing of $0.1V$ will increase 0.75mmol/L .

III. EXPERIMENTAL RESULTS

A. Amplification device comparison

An experiment needs to carry out to compare the relationship between blood glucose level and voltage produced by using the different type of amplification device. The purpose to get difference blood glucose level is to prove that voltage from the test strip will increase proportionally with the blood glucose level. A set of value is capture to compare the trend of voltage with blood glucose level. First, the experiment that has been done to calculate the blood glucose previously was using instrumentation amplifier. The same method was conducted when the amplification device is changed to the operational amplifier by using LM741. Figure 7 shows the result of the relationship between blood glucose level with voltage level when using operational amplifier LM741.

TABLE 2: RELATIONSHIP BETWEEN BLOOD GLUCOSE LEVEL AND VOLTAGE AFTER AMPLIFY WITH OPERATION AMPLIFIER LM741

Blood sample no.	Voltage/V	Glucose level mmol/L
1	2.37	4.1
2	2.46	4.8
3	2.48	4.7
4	2.60	5.7
5	2.63	6.1
6	2.71	5.8
7	2.74	6.4
8	2.78	6.2
9	2.82	6.5
10	2.91	6.7

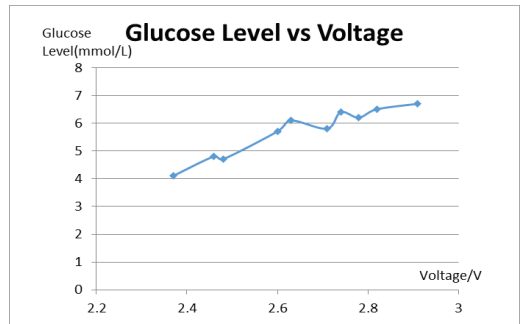

Fig. 7. Relationship between blood glucose level and voltage using LM741

From Table 1 and Table 2, can observe that the voltage from the test strip increases proportionally with the blood glucose level. The output voltage from the test strip was amplified by two different types of the amplifier which is the instrumentation amplifier and operational amplifier. All the result is taken from different blood sample to get difference blood glucose level reading. By compare two set of result captured, the output voltage amplifies by the instrumentation amplifier show a smoother graph compares to the operational amplifier. The output voltages amplify by using instrumentation amplifier shown in Fig. 6 can be considered as a linear graph. This is because of the instrumentation amplifier will remove the need for input impedance matching to maximize the power transfer. The reason instrumentation amplifier show a smoother graph than operational amplifier is

instrumentation amplifier is a low noise and low DC offset compare to the operational amplifier.

From operational amplifier graph in Fig. 7, the voltage reading is observed that not showing a linear line when increasing of blood glucose level. This is because the output voltage from the test strip will influence by noise during amplification and lead the output voltage deviates from the actual reading. Knowing that the signal from the test strip is in microampere (uA), a small noise from the circuit will bring a huge difference in the output voltage.

B. Accuracy test on the developed blood monitoring device

Based on the instrumentation amplifier which has been chosen, the experiment to evaluate the accuracy of the blood glucose monitoring device is conducted. This experiment requires 10 adults sample and their blood glucose level are tested by using a normal blood glucose meter. The result obtained is recorded in Table 3. Then, the step mention above is repeated by using the designed system. The data which has been collected will be used to evaluated system accuracy by comparing both results captured.

TABLE 3: COMPARISON BETWEEN BLOOD GLUCOSE LEVEL USING GLUCOSE METER AND PROJECT DEVICE

Blood sample no.	Using glucose meter, mmol/L	Using developed blood glucose monitoring device, mmol/L	Accuracy error, %
1	4.2	4.3	2.4%
2	4.5	4.8	6.6%
3	4.6	4.5	2.2%
4	4.6	4.4	4.5%
5	4.8	5.1	6.3%
6	5.5	5.9	7.2%
7	6.7	7.2	9.1%
8	5.6	6.1	8.9%
9	6.1	6.7	8.2%
10	6.2	6.6	6.5%

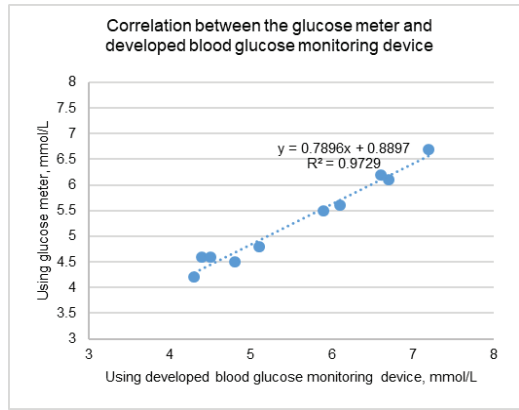

Fig. 8. The correlation between blood glucose level by using the glucose meter and the developed blood glucose monitoring device

The correlation between the blood glucose level by using the glucose meter and the developed blood glucose monitoring device is shown in Table 3 and Fig. 8. From this result, the correlation is almost linear where the R2 = 97%. The accuracy error, which is shown in Table 3, can be calculated by using the formula in Eq. 5.

$$Accuracy\ error = \frac{(Actual\ value - Project\ value)}{Actual\ value} \quad (5)$$

The sum up all accuracy error and divide by 10 to get the average accuracy error. Therefore, the average accuracy error is 6.19% from the result taken. The reason error occurs is because the data taken from the relationship between blood glucose level and voltage might not so accurate. The result taken from Table 4.1 will directly influence the calculation of blood glucose level in the software part. In order to get a more accurate reading, more blood sample need to be collected to make a more complete data of the relationship between blood glucose level and voltage. The formula used to calculate blood glucose level need to make from data collect and analysis the trend of the graph.

C. Repeatability test on the developed blood monitoring device

The repeatability test also was done in this project device to evaluate the device performance. There is 10 samples value of blood glucose level from the same blood sample is tested by using

designed blood glucose monitoring system. Table 4 and Fig. 9 show the experimental result for the repeatability test.

TABLE 4: REPEATABILITY TEST RESULT

Test no.	Glucose level mmol/L
1	4.7
2	4.6
3	4.7
4	4.5
5	4.8
6	4.4
7	4.6
8	4.8
9	4.5
10	4.6

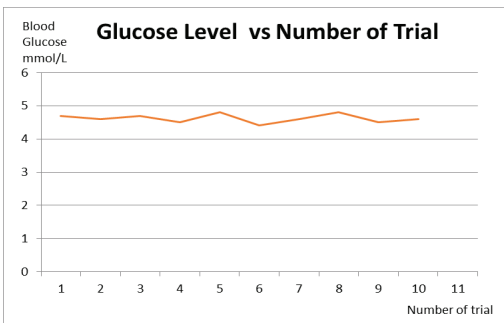

Fig. 9. Repeatability test on developed blood monitoring device

From Fig. 9, the developed blood glucose monitoring device obtained is high in repeatability. The blood glucose level measured by using the designed device give a consistency value since the blood used for this 10 samples value come from the same person and should have the same blood glucose level.

IV. CONCLUSION

In this paper, the developed blood glucose monitoring device has been successfully constructed and the system functionality has been tested with the designed experiment. This project has achieved the objective when the blood glucose monitoring device is able to measure the blood glucose level and is automatically able to transmit the data from the device into computer. Limitation of this project

occurs when the accuracy of the device become lower while measuring high blood glucose level user. During the experiment, it is found out that the device measurement will have lower accuracy when high glucose level is measured. This happen when the data collected observes the relationship between the blood glucose level and the voltage level is not comprehensive. The data collected is not enough to cover all range of blood glucose level, then some errors might occur during calculation time. The formula used to calculate blood glucose level is a linear equation but in actual time there might have some deviation since the collected data is limited. Besides, the blood glucose test must be captured in the first 10 seconds and if it does happens afterward, the voltage from the test strip will drop and cause an inaccurate result.

ACKNOWLEDGMENT

This research is a collaboration project between Auro Technologies PLT and Centre of Excellence Robotics, Instrumentation and Automation (CERIA) in Universiti Teknikal Malaysia Melaka.

REFERENCES

- [1] Health Facts 2014, Ministry of Health Malaysia.
- [2] Mustaffa BE, Diabetes epidemic in Malaysia, Medical Journal malaysia, vol. 59, pp. 295-296, 2004.
- [3] Zaini A, Where is Malaysia in the midst of the Asian epidemic of diabetes mellitus? Diabetes Research and Clinical Practices, vol. 50, Suppl 2, pp. 23- 28, 2000.
- [4] Adam Cloe, How Does A Glucose Monitor Work, Glucose Meter, available at: [http://www.livestrong.com/article/34498-glucose-monitor-work\(LiveStrong Foundation\)](http://www.livestrong.com/article/34498-glucose-monitor-work(LiveStrong Foundation)) [Accessed 17 March 2013]
- [5] Y. Mendelson, a C. Clermont, R. a Peura, and B. C. Lin, "Blood glucose measurement by multiple attenuated total reflection and infrared absorption spectroscopy.," IEEE transactions on bio-medical engineering, vol. 37, no. 5, pp. 458-65, May 1990.
- [6] Katsuhiko Kuwa, Toshimasa Nakayama, Tadao Hoshino, Makoto Tominaga, Relationships of glucose concentrations in capillary whole blood,

- venous whole blood and venous plasma, *Clinica Chimica Acta*, Volume 307, Issues 1–2, Pages 187-192, May 2001.
- [7] B. Paul, M. P. Manuel, and Z. C. Alex, “Glucose Measurement System,” pp. 2–5, 2012.
- [8] B. R. Jean, E. C. Green, and M. J. McClung, “A microwave frequency sensor for non-invasive blood-glucose measurement,” 2008 IEEE Sensors Applications Symposium, pp. 4–7, Feb. 2008.
- [9] J. N. Patel, B. Gray, B. Kaminska, and B. Gates, “Electro-Enzymatic Sensor for Non-Invasive Glucose Measurement,” 2007 Canadian Conference on Electrical and Computer Engineering, pp. 421–424, 2007.
- [10] Cuauhtemoc Medina Rimoldi, Achieving Efficiency in Blood Glucose Meter, available at: <http://www.eetimes.com/design/test-and-measurement/4204495/Blood-Glucose-Meter-Design> (EE Times) [Accessed 19 March 2013]
- [11] WH Mohd Saad, NA Abd Salam, F Salehuddin, MH Azmi Ali, SA Abd Karim, Study on Different Range of NIR Sensor Measurement for Different Concentration of Glucose Solution, *International Journal of Human and Technology Interaction (IJHaTI)*, vol. 1, no.1, pp. 13-18, 2017.
- [12] Syarulnaziah Anawar, Farah Nabilah Mahmud, Zakiah Ayop, Erman Hamid, Wai Hong Yeoh, User Autonomy Across Demographics in Mobile Health Applications, *International Journal of Human and Technology Interaction (IJHaTI)*, vol. 2, no.2, pp. 83-90, 2018.