

Analysis on Effect of Ball Bladder Size during Water Hammer in Domestic Water System

Open
Access

Faarih Farhan Mohd Nasir¹, Mohd Shahir Kasim^{2,*}, Raja Izamshah², Mohammad Shah All Hafiz², Jaharah A Ghani¹, Ahmad Anas Yusof³, Pui Kei Wong², W Noor Fatihah Mohamad^{2,4}

- ¹ Faculty of Engineering and Built Environment, Universiti Kebangsaan Malaysia, 43600 UKM Bangi, Selangor, Malaysia
² Fakulti Kejuruteraan Pembuatan, Universiti Teknikal Malaysia, Hang Tuah Jaya, 76100, Durian Tunggal, Melaka, Malaysia
³ Fakulti Kejuruteraan Mekanikal, Universiti Teknikal Malaysia, Hang Tuah Jaya, 76100, Durian Tunggal, Melaka, Malaysia
⁴ Faculty of Innovative Design and Technology, Universiti Sultan Zainal Abidin, 21300 Kuala Terengganu, Terengganu, Malaysia

ARTICLE INFO

ABSTRACT

Article history:

Received 13 February 2019
Received in revised form 8 August 2019
Accepted 18 August 2019
Available online 19 September 2019

Water hammer is a common phenomenon when a home pipe suddenly shuts down. The phenomenon may lead to pump failure, water system fatigue, pipe rupture and contaminated water backflow, and thus produces a loud banging or hammering noise. To prevent this phenomenon, a suitable accumulator is a must. Therefore, the objective of this research is to identify the exact volume of the bladder needed in the accumulator to overcome water hammer in the domestic water system. A ball bladder type of accumulator was chosen due to its flexibility, lightweight and capability to absorb hydraulic shock during the water hammer. The diameter of the ball bladder was 75 mm. There were two parameters for the experiment, namely water pressure during water hammer and the effect of ball bladder size on the hydraulic shock. These parameters were analysed to reduce the effect of water hammer in the future. The experiments were conducted by using DAQami software to understand the behaviour of the shock wave due to water hammer in the presence of a ball bladder. The outcome of analysis showed that the accumulator with four ball bladders with size of 883.57 cm³ (2.79 bar), had the slowest time in terms of water pressure increase when the test valve was shut down suddenly. In addition, there was no leakage at the pipe, no water droplets and no noisy sound from the pump when the test valve is shut down immediately or suddenly. Besides, the pressure of the shock wave was reduced from 4.00 bar to 2.79 bar, leading to a reduction of 1.21 bar (30%). This research revealed that the appropriate size of ball bladder for the domestic water system to prevent water hammer was 1523.33 cm³, which was approximated to seven ball bladders

Keywords:

Water hammer; ball bladder
accumulator; shock wave; domestic
water system

Copyright © 2019 PENERBIT AKADEMI BARU - All rights reserved

1. Introduction

Domestic water system (DWS) is defined as a system for collecting, handling, transmitting, storing and distributing water from the source to consumers. DWS provides consumers with sufficient clean

* Corresponding author.

E-mail address: shahir@utem.edu.my (Mohd Shahir Kasim)

water. Water pressure for DWS is between 200 kPa–690 kPa. Nevertheless, most home appliances are designed to operate with the water pressure of between 100 kPa to 830 kPa [1]. In Malaysia the total water consumption increases from 14,391 million litres per day (MLD) in 2015 to 15,201 MLD in 2016 [2]. The possibility of detecting and estimating a small water leakage in a single pipe by means of an unsteady-state examination, giving a boost to small overpressure, was evaluated on the foundation of a thorough investigation [3]. Water leakage, if it is not properly tackled, may lead to excessive damages, such as spoiling of concrete, pipe and steel corrosion, and concrete reinforcement, which may affect the integrity of a concrete building construction [4].

Water hammer is the quick and frequent high pressure and variations caused by transient water movements in pipelines. Transients may result in high-pressure forces and agile, fluid acceleration into water pipes [5]. Water hammer may not only lead to equipment damage, but also possible injury to the plant personnel [6]. Water hammer occurs when there is a sudden rapid valve closure that blocks water flow in pipelines. A water hammer pressure wave may cause major problems, which range from noise and vibration to pipe collapse [7]. The instantaneous pressure caused by water hammer accelerates liquid in a pipeline which can be ten times greater than the steady flow pressure produced by a centrifugal pump. Centrifugal pumps normally produce non-damaging high-frequency but low-amplitude pulses, which are the pressure spikes [8]. Rapid liquid flow in pipeline systems is a high hazard in terms of hydraulic flow system safety [9]. Water hammer is caused by pressure in pipelines, the speed of water flowing in pipelines and its quick-change [10]. Hydraulic shock is a momentary rise of fluid pressure when the fluid flow is suddenly stopped. If the flow is stopped in less than half a second for the closing speed of the valve, then a pressure spike over 100 psi greater than the system operating pressure can be generated.

Pressure spikes can also easily exceed five to 10 times the working pressure of the system upon impact, thereby placing a great deal of stress on it [11]. To deal with water hammer effects, accumulators and other damping appliances are installed. However, the fluid velocity is the only parameter that can be adjusted to reduce the impact [12]. Accumulators absorb energy when the water system pressure is higher than the accumulator and release hydraulic energy when the water system pressure is lower than the accumulator [13]. Ball bladder accumulator has high flexibility and is lightweight; hence, the accumulator is able to rapidly compensate for pressure drop in the water system and restrain damage in pipelines and other appliances [14].

2. Methodology

2.1 Equipment

Shock wave guard or test rig (TR) acts as a realistic simulation of water hammer. TR is a prototype of the domestic water supply that has actual domestic pressure, which is 200 kPa (2.0 bar). The function of TR is to test the ball bladder accumulator and simulation for water hammer that usually happens in a DWS. TR is powered by a direct current (DC) water pump to ensure that the water pressure produced is close enough to the real DCW. Figure 1(a) shows the two-dimensional (2D) drawing of test rig before setup, while Figure 1(b) shows the test rig after setup.

A water pump is used to make a continuous water flow in the TR and its location is near the water reservoir inside the TR. The presence of a pressure gauge is significant to show water pressure when the pump is on. A ball bladder accumulator is chosen because of its light-weight and flexibility. It may rapidly compensate pressure drops in the water system and restrain damage in pipelines. The ball bladder accumulator is more preferable for water service. A ball bladder accumulator is more suitable to be used during a sudden failure for the DSW. It is suitable for vertical installation position with the hydraulic port facing downwards. This is to ease the flow out of air trapped inside the accumulator

container. A suitable size of the accumulator is important to ensure long life service and efficiency. Figure 2 shows a three dimensional (3D) model of the ball bladder accumulator.

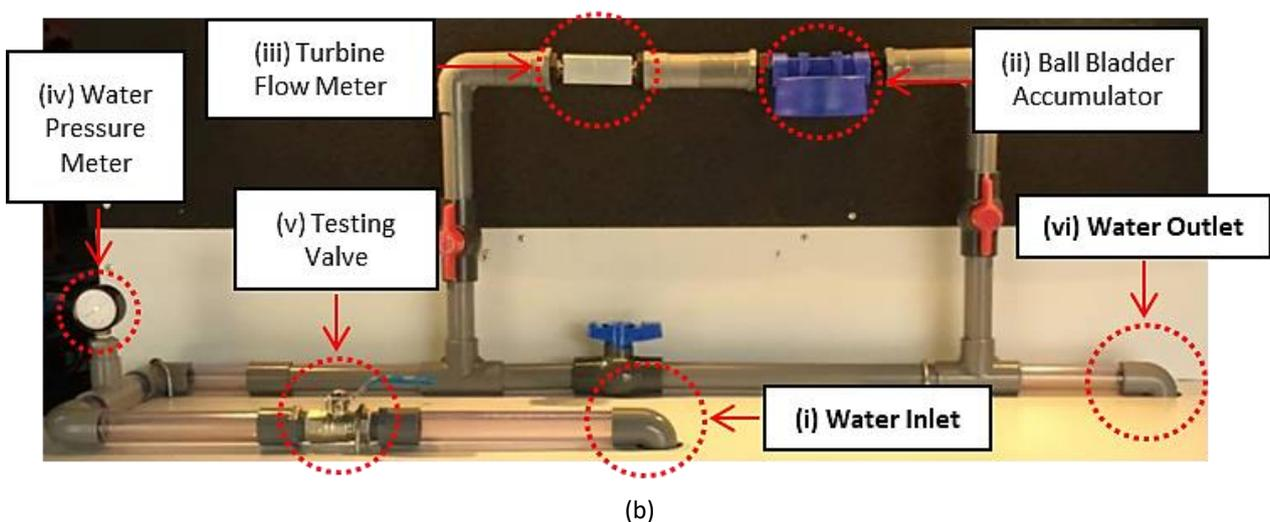
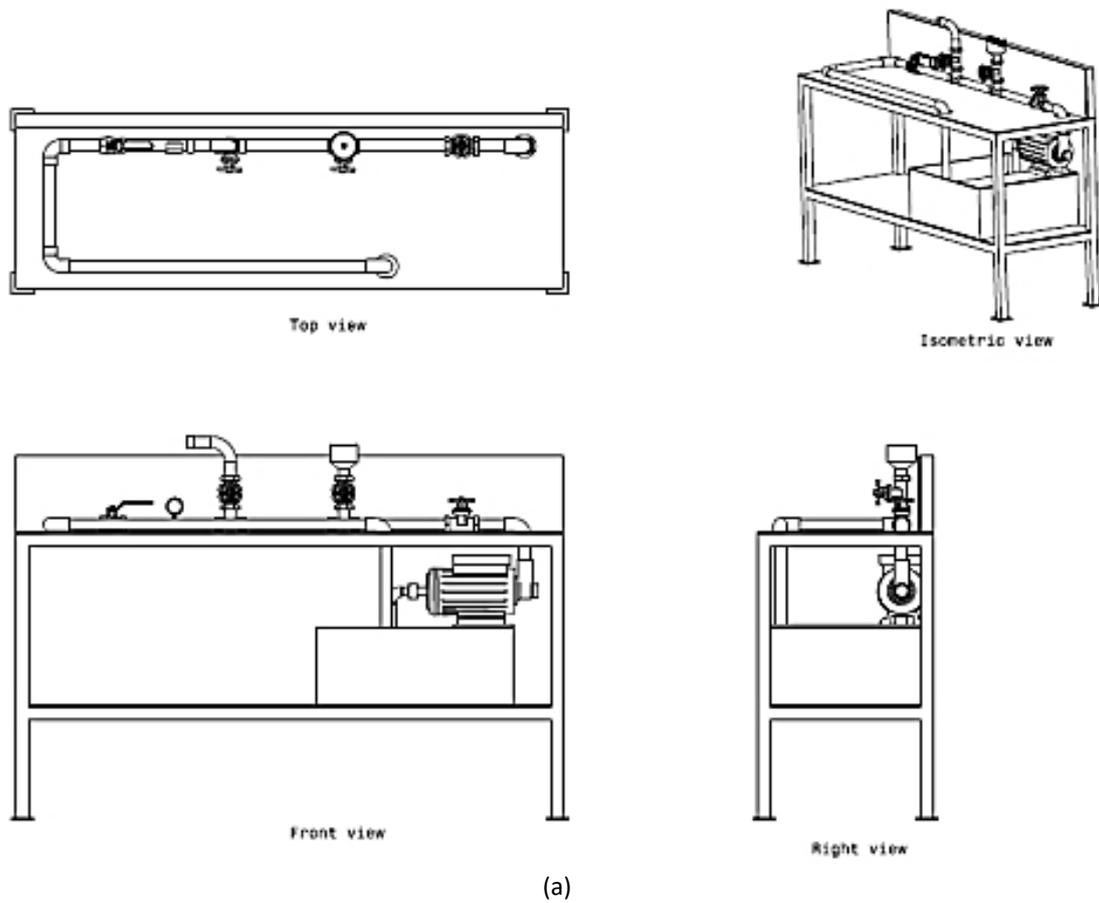

Fig. 1. Setup of testing rig (TR); (a) drawing of testing rig before setup, and (b) testing rig after setup



Fig. 2. 3D model of ball bladder accumulator

The colour of the bladder accumulator housing is transparent because it can clearly show the reaction of the ball bladder inside it during the water hammer. Therefore, an analysis of the experiment can be easily done. An added advantage of the bladder accumulator housing is that it can hold water pressure of up to 8.62 bar. The ball bladders inside the housing act as shock preventers. These are installed in a system so that their capacitance can prevent a shock from occurring by allowing a deceleration time for the fluid. Nevertheless, in nearly every case, these units must have entries, which are substantially as great as the diameter of the vessel itself. Besides, the ball bladders must be made of flexible rubber to enable them to rapidly compensate for pressure drops in the water system and restrain damage in the pipelines and other appliances. The ball bladder has dry inert gas that can expand and contract to discharge and allows the shock wave into the accumulator. Therefore, a rubber ball was chosen to act as the ball bladder. Figure 3 shows that the pressure transducer is attached to the aluminium body. An aluminium body was used because it can resist corrosion as the experiment was conducted by using water. A 12V battery can operate the pressure transducer. When water enters the aluminium body according to flow and the transducer will generate a pulse in the pickup coil. These impulses produce an output frequency proportional to the volumetric flow through the transducer. Then the output frequency is sent to the data logger to be interpreted by using the DAQami software. The output frequency is used to represent water pressure.

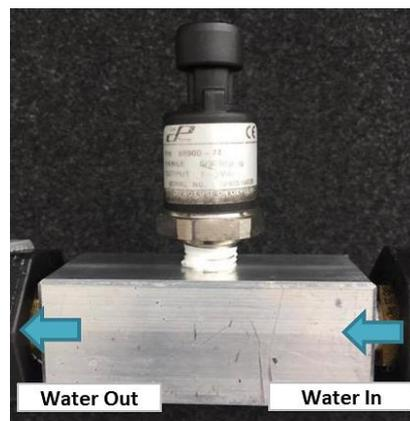

Fig. 3. Water path inside pressure transducer

Data logger (USB-1208FS-Plus) is a data acquisition (DAQ) device that records data over time or in relation to the location either with a built-in instrument (sensor) or via external instruments and sensors. The device is designed for low to medium channel count applications. This device provides

analog input along with digital I/O and counter functions. It features 12-bit resolution and two analog outputs. DAQ is the process of measuring an electrical or physical phenomenon, such as voltage, current, temperature, pressure, or sound with a computer. DAQ system consists of sensors, DAQ measurement hardware, and a computer with programmable software. Therefore, DAQami software was chosen as the data logger to measure the shock wave that occurred during water hammer (Figure 4).



Fig. 4. Measurement instrument of the shock wave

2.2 Theoretical Calculation

The calculation steps were divided into three parts. The first part was to calculate the water hammer. The formula below was used to calculate the increase in pressure produced during water hammer, P [15]:

$$P = \frac{0.07 (VL)}{t} + P_1 \quad (1)$$

where,

P = Increase in pressure (psi)

P₁ = Inlet pressure (psi)

V = Flow velocity (ft/s)

L = Length of straight pipe between source and point where reduction of velocity occurred, the longest section, in meter (straight pipe means no tee's or ell's) in ft

T = Time during which the velocity was reduced, in seconds (valve closure times are typically available from the manufacturer of the valve being used) in second (s)

0.07 = Constant used to convert velocity, length and time into pressure

From Eq. (1), the pressure was increased by 210 kPa during water hammer. Therefore, it increased the pressure during water hammer to 4.1 bar. The pressure increased twice when water hammer occurred. The second part was to calculate the size of the ball bladder:

$$V = \frac{4}{3}\pi r^3 \quad (2)$$

where,

- V = Volume (cm³)
- π = Constant value which is approximately 3.14159
- r = Radius (cm)

In Eq. (2), the volume (V) for one ball bladder used in this project was 220.89 cm³. The size of the ball bladder used depends on the quantity of balls used in the ball bladder accumulator. The third part was to calculate the flow rate of water:

$$Q = Av \quad (3)$$

where,

- Q = Liquid flow rate (m³/s or L/s)
- A = Area of the pipe or channel (m²)
- v = Velocity of the liquid (m/s)

From Eq. (3) where, A = 0.00051 m² and v = 2 m/s, the water flow rate (Q) is equivalent to 1.02 x10⁻³ m³/s.

2.3 Actual Calculation

Eq. (4) was used to calculate the increase in pressure when the water hammer occurred in the DAQami software graph. This equation was used for calculating the actual pressure value of water hammer and is illustrated in Figure 5.

$$P_{wh} = P_{peak} - \text{error} + P_{sys} \quad (4)$$

where,

- P_{wh} = Pressure of water hammer (bar)
- P_{peak} = Pressure of water spike during water hammer (bar)
- error = Starting of the graph due to noise occurs in the system (bar)
- P_{sys} = Pressure of the domestic water system. A constant value which is equal to 2.0 bar

In Eq. (4), P_{wh} represents the pressure of water hammer (bar), P_{peak} is the pressure of water spike during water hammer (bar), error is at the start of graph, which is due to noise occurring in the system (bar) and P_{sys} is the pressure of the DWS.

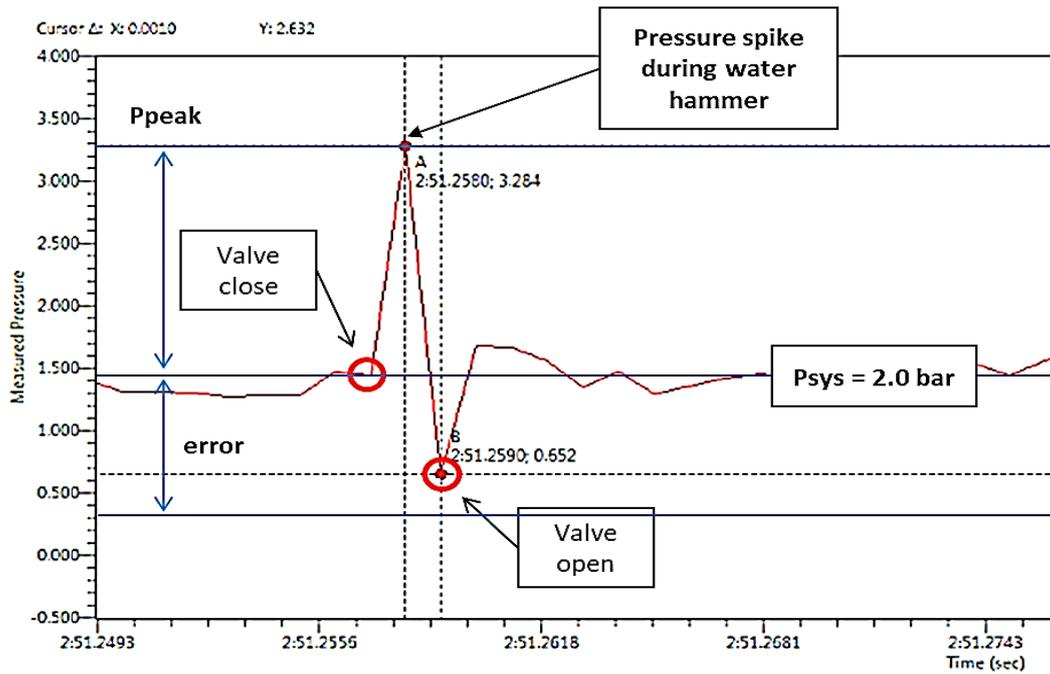

Fig. 5. Graph for Actual Pressure of Water Hammer

3. Results and Discussion

3.1 Size of Ball Bladder

This parameter focuses on the capability of the ball bladder size that is required in the accumulator to absorb the shock wave during the water hammer so as to reduce pipeline damage. The parameters such as pipe diameter and water velocity remains constant. The criteria that will be observed from this parameter were the time of water pressure increase when test valve is shut down, leakage at the pipeline, the reaction of the ball bladder to absorb the shock wave and sound of the pump when test valve is shut down immediately or suddenly. Table 1 shows the result of the ball bladder size. Figure 6(a) shows the accumulator with ball bladder before water hammer occurs, while Figure 6(b) shows the reaction of ball bladders when absorbing the shock wave during the water hammer.

Table 1

Result for the size of ball bladder

No. of exp.	No. of ball bladder	Size of ball bladder (cm ³)	Pressure of water hammer (bar)	Leaking at pipeline	Water droplets	Time of water pressure increase (ms)	Sound of pump
1	0	0.00	4.00	Yes, Leaking at the elbow and joint	Yes, Faster and continuously	2.10	Noisiest
2	1	220.89	3.34	Yes, Leaking at the elbow and joint	Yes, Fast and continuously	1.90	Noisier
3	2	441.79	3.25	Yes, Leaking at the joint	Yes, Slow and continuously	1.87	Noisy
4	3	662.68	3.11	Yes, Leaking at the elbow	Yes, Slower and randomly	1.81	Less noisy
5	4	883.57	2.79	No leaking	No water droplets	1.70	Not noisy

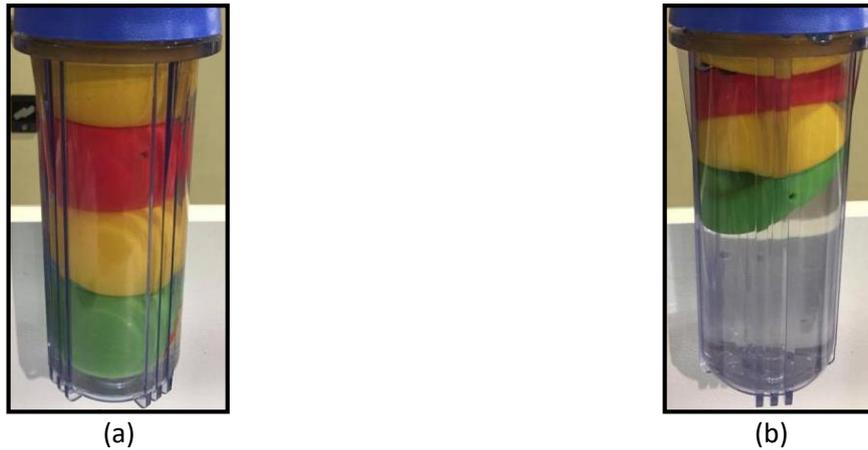

Fig. 6. The reaction of ball bladder in the accumulator (a) before and, (b) after water hammer occurs

Based on the ball bladder size observation, water hammer can cause pipe failure if the pressure is high enough. Figure 7(a) shows the leaking area at pipe joint during water hammer, while Figure 7(b) shows water droplets at the pipe elbow caused by water hammer.

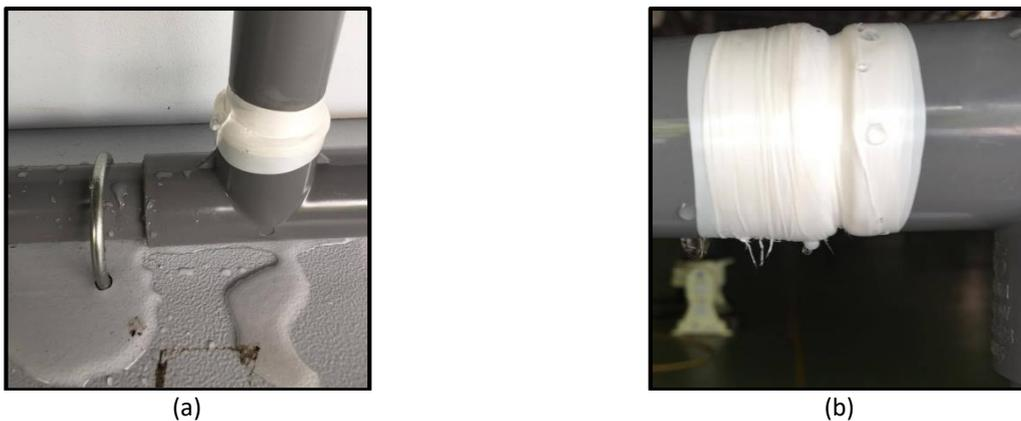

Fig. 7. Effect of water hammer; (a) leaking area at pipe joint and, (b) water droplets at pipe elbow

3.2 Pressure of Water during Water Hammer

During water hammer, the shock wave behaviour occurs when the valve is shut down immediately or suddenly. Therefore, the water pressure will increase and cause damage to the pipeline. This was supported by Yusof [16], whereby his study showed that the increase in pressure by using water in the mechanical system would result in product quality damage. The data was graphically shown by using DAQami software, which is specified in measuring water pressure. Eq. (4) was used to calculate the water hammer pressure. When the test valve was opened, the water pressure dropped and needed time to normalise the pressure back to the original. The time taken for the water hammer to occur was 0.01 s.

Based on data from Table 1, water hammer can cause an increase in water pressure to double from its original pressure, which was 2.0 bar. With the presence of the ball bladder accumulator in the Psystem, the increase in water pressure due to water hammer can be reduced. Percentage of error between theoretical and experimental values can be calculated based on Eq. (5). The theoretical value was 4.1 bar, as calculated from Eq. (1)

$$\% \text{ Error} = \left| \frac{\text{Theoretical Value} - \text{Experimental Value}}{\text{Theoretical Value}} \right| \times 100 \quad (5)$$

The total water pressure increase during water hammer for the experimental value was 4.0 bar. Therefore, the percentage error between theoretical and experimental values was 2.4%. Eq. (6) shows the percentage for water pressure reduction in the presence of a ball bladder. The water pressure value without the ball bladder was constant due to the rise in pressure during water hammer without the ball bladder interference, which was 4.0 bar. Table 2 shows the percentage of water pressure reduction during water hammer.

$$\% \text{ Reduction} = \left| \frac{\left(\frac{\text{water pressure without ball bladder}}{\text{water pressure with ball bladder}} \right)}{\text{water pressure without ball bladder}} \right| \times 100 \quad (6)$$

Table 2

Percentage of reduction for water pressure during water hammer

No. of ball bladder	Water pressure reduced (bar)	Percentage of reduction (%)
1	0.66	17
2	0.75	19
3	0.89	22
4	1.21	30

Table 2 shows that four-ball bladders in the accumulator had the highest percentage of reduction, which was 30% or a reduction of 1.21 bar. In Table 1, the graph was plotted based on the data from the ball bladder size and water hammer pressure. The purpose is to predict the appropriate ball bladder size during water hammer for the DWS. The graph will enable the formulation to predict the ball bladder size.

Figure 8 shows the prediction for having the appropriate ball bladder size to prevent water hammer in DWS, which was calculated based on Eq. (7). The appropriate ball bladder size to prevent the water hammer was 1523.33 cm³, which was equivalent to the pressure of the DWS (2.0 bar).

$$y = -0.0012x + 3.828 \quad (7)$$

where,

y = Pressure of water hammer (bar)

x = Ball bladder size (cm³)

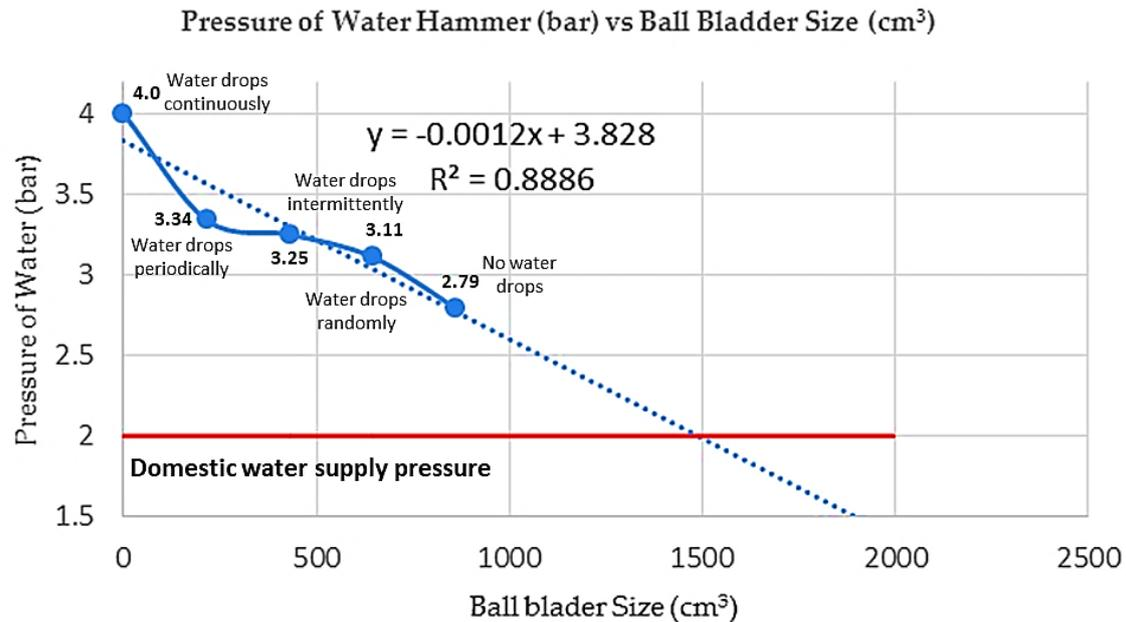

Fig. 8. The pressure of water hammer versus the size of ball bladder

4. Conclusions

This paper describes an analysis of the ball bladder size effect during water hammer in the DWS. Based on the analysis, the following conclusions were drawn from the research.

- i. Water hammer can cause pipe failure if the pressure is high enough. Water leakage in the pipe will occur at the elbow or pipe joint. The presence of a ball bladder accumulator can slow down the time taken for water pressure to increase. For best result, the accumulator should have four ball bladders; time for water pressure to increase is slowest when the test valve is shut down; no leakage at the pipeline; no water droplets coming out of the leakage; and the pump does not have a noisy sound when the test valve is shut down immediately or suddenly. The presence of a ball bladder accumulator reduces water hammer pressure because the ball bladder can absorb the shock wave and reduce the time for water pressure to increase.
- ii. Water hammer can cause water pressure to increase to double its original pressure, which was 2.0 bar. With the presence of a ball bladder accumulator in the system, the increase in water pressure due to water hammer can be reduced. The pressure of the shock wave was reduced with the presence of four ball bladders (883.57 cm³) inside the accumulator, which was from 4.00 bar to 2.79 bar and a reduction of 1.21 bar (30%). This leads to a finding that the size of ball bladder accumulator affects water hammer pressure.
- iii. The appropriate ball bladder size for the DWS was 1523.33 cm³, which was approximated to seven of 75 mm dia. ball bladders.

Acknowledgement

The authors thank the Universiti Teknikal Malaysia Melaka (UTeM) and the Ministry of Education Malaysia (MOE) for funding this research project through grants no: FRGS/2018/FKP-AMC/F00378 and also the assistance from the Advanced Manufacturing Centre (AMC UTeM) and Faculty of Manufacturing Engineering at UTeM for their practical support.

References

- [1] D. W. System, "National Water Resources Study: Master Action Plan, Malaysia," 2015.
- [2] Suruhanjaya Perkhidmatan Air Negara, "Laporan Tahunan 2016," Cyberjaya, 2016.
- [3] Brunone, Bruno, and Marco Ferrante. "Detecting leaks in pressurised pipes by means of transients." *Journal of Hydraulic Research* 39, no. 5 (2001): 539-547.
- [4] Chew, M. Y. L., Nayanthara De Silva, and S. S. Tan. "Maintainability of wet areas of non-residential buildings." *Structural Survey* 22, no. 1 (2004): 39-52.
- [5] Abuiziah, Itissam, Oulhaj Ahmed, and Ouazar Driss. "Sizing the protection devices to control water hammer damage." *Int. J. Civil, Archit. Sci. Eng.* 7, no. 11 (2013): 415-420.
- [6] R. A. Graham, *Shock Wave Reflection Phenomena*, 2nd Edition. Berlin, Heidelberg: Springer Berlin Heidelberg, 2007.
- [7] Lee, Jun-Shin, Bong-Ki Kim, Wook-Ryun Lee, and Ki-Yong Oh. "Analysis of water hammer in pipelines by partial fraction expansion of transfer function in frequency domain." *Journal of Mechanical Science and Technology* 24, no. 10 (2010): 1975-1980.
- [8] "What are the Effects of Water Hammer and Pulsation?," *Applied Measurement Limited*. [Online]. Available: <https://appmeas.co.uk/resources/pressure-measurement-notes/what-are-the-effects-of-water-hammer-and-pulsation/>. [Accessed: 11-Feb-2019].
- [9] Adamkowski, A., and M. Lewandowski. "Consideration of the cavitation characteristics of shut-off valves in numerical modelling of hydraulic transients in pipelines with column separation." *Procedia Engineering* 70 (2014): 1027-1036.
- [10] Choon, Tan Wee, Lim Kheng Aik, Lim Eng Aik, and Teoh Thean Hin. "Investigation of water hammer effect through pipeline system." *International Journal on Advanced Science, Engineering and Information Technology* 2, no. 3 (2012): 246-251.
- [11] A. Bregman, "Back To Basics: Water Hammer," *Valve Magazine*, 2017. [Online]. Available: <http://www.valvemagazine.com/magazine/sections/back-to-basics/8418-water-hammer.html>. [Accessed: 11-Feb-2019].
- [12] Boulos, Paul F., Bryan W. Karney, Don J. Wood, and Srinivasa Lingireddy. "Hydraulic transient guidelines for protecting water distribution systems." *Journal-American Water Works Association* 97, no. 5 (2005): 111-124.
- [13] A. Staff, "Accumulators," *Hydraulics & Pneumatics*, 2012. [Online]. Available: <https://www.hydraulicspneumatics.com/200/TechZone/Accumulators/Article/False/6446/TechZone-Accumulators>. [Accessed: 11-Feb-2019].
- [14] Mir Rajabi, Mehdi. "The deep water gas charged accumulator and its possible replacements." PhD diss., Texas A&M University, 2006.
- [15] Y. Bengali and R. Bolger, "The Effects of Water Hammer and Pulsation," *Plast-O-Matic Valves, Inc.* [Online]. Available: <https://plastomatic.com/technical-article/water-hammer-pulsation/>. [Accessed: 11-Feb-2019].
- [16] Ahmad Anas Yusof, Suhaimi Misha, Mohamed Hafiz Md Isa, Faizil Wasbari, Mohd Qadafie Ibrahim, and Mohd Shahir Kasim. "Simulation and experimentation of water hydraulics technology for automatic traditional cookies production." *J. Adv. Res. Fluid Mech. Therm. Sci.* 47, no. 1 (2018): 136-150.