

# Design of a Broadband Microstrip Array Antenna for 5G Application

Husam Alwareth, Maisarah Abu and I. M. Ibrahim

*Centre for Telecommunication Research and Innovation (CETRI), Faculty of Electronics and Computer Engineering (FKEKK), University Technical Malaysia Melaka (UTeM).*

*hussam.w@hotmail.com*

**Abstract**— This paper presented a study that analyses the enhancement of high gain microstrip array antenna for 5G applications operating at 28 GHz designed to meet the ETSI standardization. It is expected that the gain must be high at high operating frequency so that it can compensate the propagation path loss. The objective of this study was to design a 16-element microstrip array antenna located at the top of antenna as a rectangular patch. Aiming to achieve low loss and high antenna efficiency, the material used for the proposed design was Roger 5880 materials with the permittivity of 2.2 and thickness of 0.25. Initially, a rectangular microstrip array antenna with 4 elements was designed. After analyzing the outcomes of antenna features such as reflected loss, efficiency and antenna gain, the 4 elements array were transformed into 8 elements array. To achieve high gain, it was then transformed into 16 elements array. Based on EM analysis using CST software, it was found that the proposed antenna has high efficiencies and high gain of 18.5 at 28 GHz operating frequency.

**Index Terms**—5G; Array Antenna; Rectangular Microstrip Antenna.

## I. INTRODUCTION

The rapid growth of mobile data and the use of smartphones are creating unprecedented challenges for wireless service providers to overcome a global bandwidth shortage. Since the advancement of the technology from the first generation:1G, second generation:2G, third generation:3G, fourth generation:4G and soon to be realized the fifth generation:5G, each of these generations has differences and applications [1]-[2]. The fifth generation (5G) technology is expected to improve the 4G generation; thus, provides solutions to the shortage arising from 4G, such as limited bandwidth and speed. Research activities on 5G mobile communication systems are growing to meet the increasing needs for higher data rates required in future applications (such as wireless broadband connections, massive machine type communications and highly reliable networks). As 5G is developed and implemented, there will be a major requirement, especially on the user's equipment and base station infrastructures [3].

In comparison to the 4G systems, one of the major differences in 5G cellular systems is the shift to higher frequencies, leading to an easy accessibility due to wider bandwidths. Therefore, the millimeter wave bands or 5G technology can support higher data rates required by applications in the future. In addition, there are different frequency band candidates that could be potentially used for 5G, and research activities can be found in all of these bands. However, moving to these millimeter wave bands would bring new challenges in the designs of antennas for mobile

phone devices[4].

One of the challenges in designing antennas for 5G mobile phone devices is the implementation of millimeter wave antenna arrays using low-cost materials. The low-cost substrate has been used widely in custom electronic products as it features good and robust mechanical and electrical characteristics. In addition, the use of standard printed circuit board (PCB) processes makes it easier to achieve the stringent requirements on the interval distance between the antenna elements for the antenna array. However, the use of traditional antenna structures, such as printed antenna is too lossy for millimeter wave antenna designs as the gain and efficiency of the antenna would be deteriorated [5].

This paper proposed a new design of microstrip array antenna at 28GHz frequency for millimeter-wave 5G mobile applications. The proposed design consists of 16 elements, which are located at the top of antenna as a rectangular patch. The material used for the proposed design is Roger materials with permittivity of 2.2, which can be used to achieve low loss and high antenna efficiency. The EM analysis has been done using CST software. The results demonstrate that the proposed antenna has high efficiencies and high gain at 28 GHz operating frequency.

## II. LITERATURE REVIEW

The literature review was performed to collect related information and facts that can be used in the design process of this project prior to the design process. The research was carried out by performing a review of the literature related to the research topic of design broadband antenna for 5G application. The following is a summary of the reviewed journals.

David [6] designed a microstrip antenna to operate at 28 GHz and 60 GHz for 5G application by using feeding technique cascade quarter wavelength impedance and presented a return loss of -35dB and -40dB at 28GHz and 60GHz respectively. R. Ngah [7] proposed antenna consisting of 14 optimized rectangular loops with 25 radiating elements, where the result for  $S_{11}$  at 28 GHz was -24.08 dB, while the gain was 11.32 dB. Naser [8] proposed a phased array antenna consisting of 10 radiating elements operating at 28GHz using low cost FR-4 substrate, while the gain obtained was 13 dB. Stanley [9] proposed an open slot-PIFA antenna, which were made on a low cost FR4 board, while from 8 - element antenna array exhibited a gain of 13 dB. Jamaluddin [10] proposed a linear rectangular DRA array antenna with a modified feeding structure that operated at 28GHz and offered a bandwidth of 2.1GHz, while the gain was 14.4 dB. Low Ching [11] investigated three different configurations of

patch array antennas operated at 28GHz for 5G Applications. This paper investigated how the orientation of patch array antenna can affect the beam forming, and the orientation that gives a maximum performance to achieve the best gain from the three designs, which is at 8.45 dB.

### III. METHODOLOGY

The design of this approach was done by firstly, calculating the single patch at the desired frequency. Computer Simulation Technology (CST) 2016 was used to simulate the design. The basic characteristics of the antenna such as the resonance frequency, return loss, bandwidth, and directivity were considered to optimize the design of the antenna. The process for antenna array design has been completed.

#### A. Design Specification

The roger 5880 dielectric substrate was used in this design. The characteristic of the substrate is shown in Table 1.

Table 1  
The Characteristics of the Substrate

Substrate	Rogers RT/duroid 5880
Permittivity $\epsilon_r$	2.2
Thickness of substrate (h)	0.254
Thickness of copper	0.0175
Loss tangent, $\tan \alpha$	0.0009

The design specifications for this antenna are as presented in Table 2.

Table 2  
Design Specifications of Patch Antenna

Antenna Parameter	Value
Frequency, $f_r$	28 GHz
Return Loss, $R_L$	< -10
Bandwidth, BW	At least 1 GHz
Gain, G	Approximately 20 dB

#### B. Antenna Design Process

The rectangular microstrip patch antenna was designed at 28 GHz resonant frequency. The dimensions of this basic rectangular patch antenna can be determined by using the equation from [12]:

$$W = \frac{c}{2f_r \sqrt{\frac{\epsilon_r + 1}{2}}} \quad (1)$$

$$\epsilon_{eff} = \frac{\epsilon_r + 1}{2} + \frac{\epsilon_r - 1}{2} \left[ 1 + 12 \frac{h}{w} \right]^{-1/2} \quad (2)$$

$$L_{eff} = \frac{c}{2f_r \sqrt{\epsilon_{eff}}} \quad (3)$$

For length extension:

$$\Delta L = 0.412h \frac{(\epsilon_{eff} + 0.3) \left( \frac{w}{h} + 0.264 \right)}{(\epsilon_{eff} - 0.258) \left( \frac{w}{h} + 0.8 \right)} \quad (4)$$

So, the actual length from (3) and (4) into (5):

$$L = L_{eff} - 2\Delta L \quad (5)$$

Feedline for antenna array consists of a network of two way power divider branch. Quarter-wave transformer ( $70 \Omega$ ) was used to match the ( $100 \Omega$ ) to ( $50\Omega$ ) line, so the impedance of quarter-wave transformer is:

$$Z_1 = \sqrt{Z_o \times R_{in}} \quad (6)$$

where:

$$R_{in} = \frac{1}{2G_e} \quad (7)$$

$$G_e = \frac{0.00836 \times W}{\lambda_o} \quad (8)$$

For feedline dimensions:

$$\frac{w}{d} = \frac{2}{\pi} \left[ \frac{B - 1 - \ln(2B - 1) + \frac{\epsilon_r - 1}{2\epsilon_r} \times \left[ \ln(B - 1) + 0.39 - \frac{0.61}{\epsilon_r} \right]}{\left[ \ln(B - 1) + 0.39 - \frac{0.61}{\epsilon_r} \right]} \right] \quad (w/d) > 2 \quad (9)$$

where:

$$B = \frac{377\pi}{2Z_o \sqrt{\epsilon_r}} \quad (10)$$

For substrate dimensions:

$$W_s = W + 6h \quad (11)$$

$$L_s = L + 6h \quad (12)$$

For array substrate dimensions:

$$W_s = W_s + \frac{\lambda}{2} \quad (13)$$

$$L_s = L_s + \frac{\lambda}{2} \quad (14)$$

#### C. Design Parameter of Rectangular Array Antenna

The antenna design can be adjusted to fulfill the 5G requirements using parametric study method. Parametric study is a method of adjusting and comparing the width, length, its effect on the frequency, gain, return loss, directivity and surface currents. The design structures for the front of the 4x1,8x1 and 16x1 array antennas are shown in Figure 1, 2, 3, and 4. Meanwhile, Table 3 shows the optimized parameters for the 16x1 microstrip array antenna.

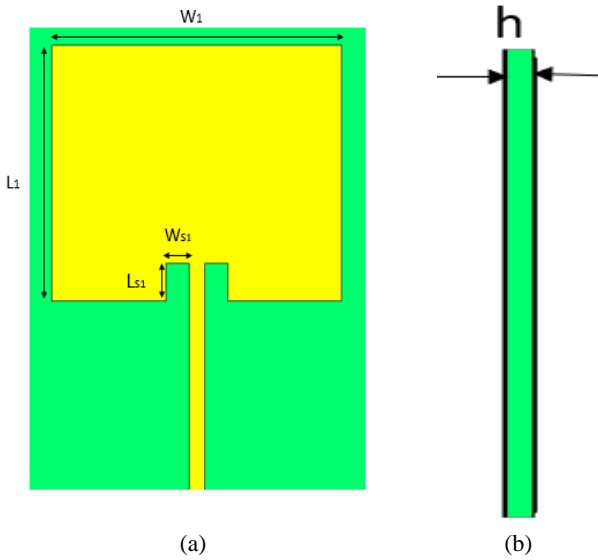

Figure 1: (a) View of the rectangular patch dimensions, and (b) side view of the antenna

Parameter of the Antenna	Dimension (mm)
t	0.0175
W <sub>3</sub>	0.787
L <sub>3</sub>	1.42857
L <sub>2</sub>	6.92
W <sub>2</sub>	0.225
S	1
W <sub>4</sub>	0.45
L <sub>4</sub>	2.73684
L <sub>5</sub>	3.46
W <sub>5</sub>	0.255
W <sub>6</sub>	0.225
L <sub>6</sub>	2.7
W <sub>S1</sub>	0.34
L <sub>S1</sub>	0.5
L <sub>7</sub>	28.775
L <sub>8</sub>	57.775

IV. SIMULATION RESULT

A. Return Loss

After the optimization processes and the parametric study have been performed to the designed array antennas, the response of 4x1 array antenna was at 28GHz with return loss of -49.038852 dB, and a bandwidth of 1.354 GHz, as shown in Figure 4.

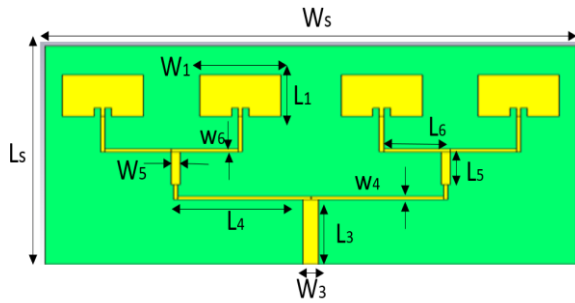

Figure 2: 4x1 microstrip array antenna

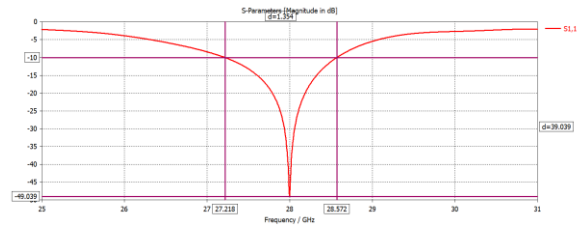

Figure 4: Return loss 4x1 array antenna

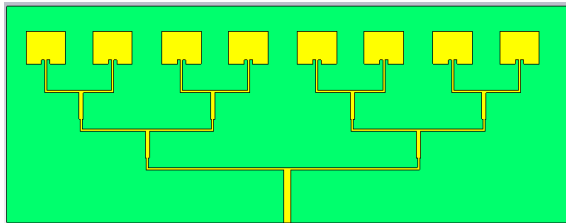

Figure 3: 8x1 microstrip array antenna

The optimization processes and the parametric study were also performed for the design of 8x1 array antenna and the results obtained a -43.0564dB return loss at 28 GHz, resulting in the achievement of a bandwidth of 2.559 GHz, as shown in Figure 5.

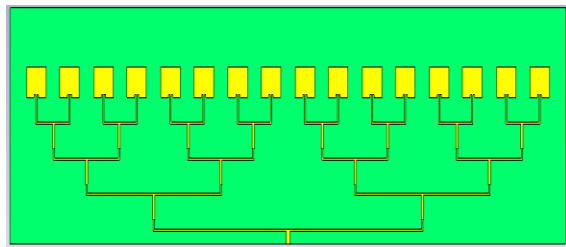

Figure 4: 16x1 microstrip array antenna

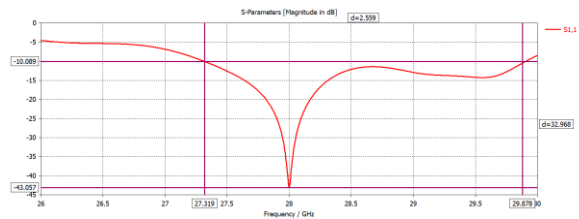

Figure 5: The return loss of 8x1 array antenna

Table 3  
16x1 Array Antenna Dimensions

Parameter of the Antenna	Dimension (mm)
W <sub>s</sub>	30
L <sub>s</sub>	26
h	0.254
W <sub>1</sub>	4.22
L <sub>1</sub>	3.356

For the third configuration of the array antenna design, a 16x1 parametric study has been performed and the results of the study obtained a return loss of -37.25414 dB at 28GHz resonance frequency, while the bandwidth was 1.3851GHz, as shown in Figure 6.

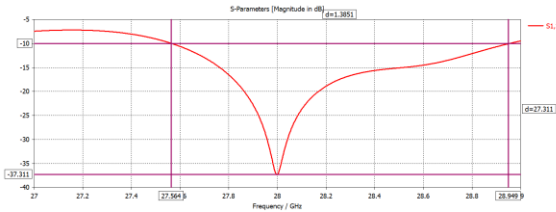

Figure 6: Return loss 16x1 array antenna

**B. Gain**

The resulted gain for the 4x1 array antenna was 12.1dB, and the obtained gain for the 8x1 array antenna was 14.91dB, whereas the gain of 16x1 array antenna was 18.5dB, as shown in Figure 7, 8, and 9. This gain can support the millimeter wave bands or 5G technology that leads to higher data rates required by the applications in the future.

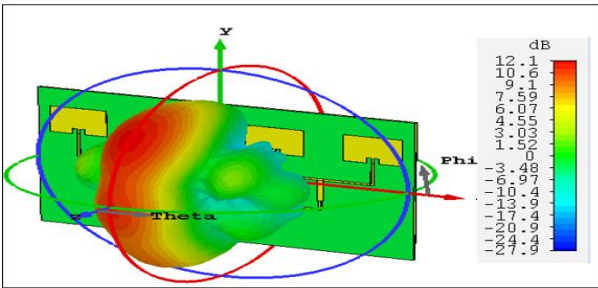

Figure 7: Gain of 4x1 array antenna

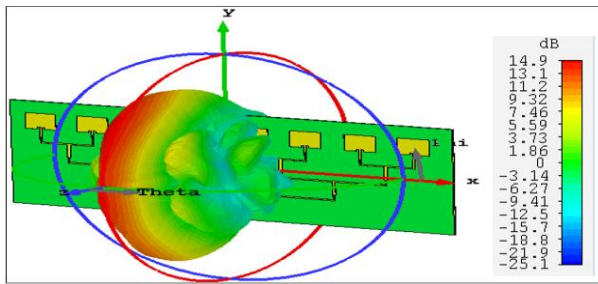

Figure 8: Gain of 8x1 array antenna

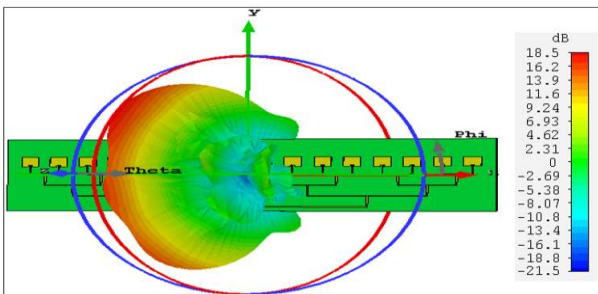

Figure 9: Gain of 16x1 array antenna

**C. Radiation Pattern**

The result was obtained by the simulation presented in terms of radiation pattern for the three configuration designs, which are the 4x1, 8x1, and 16x1 array antennas. These array antennas designs are characterised as a directional, which means that the radiation is focused on one direction rather than radiating in all directions, as shown in Figure 10, 11, and 12.

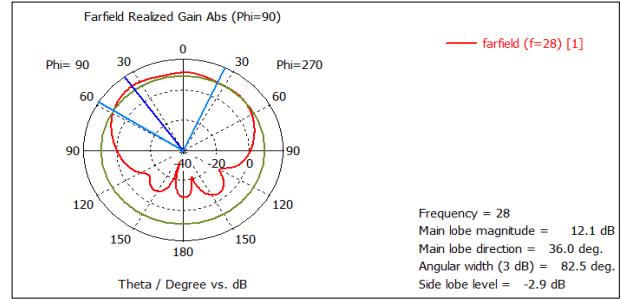

Figure 10: Radiation pattern of 4x1 array antenna

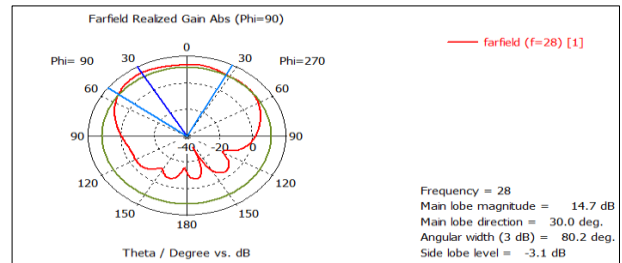

Figure 11: Radiation pattern of 8x1 array antenna

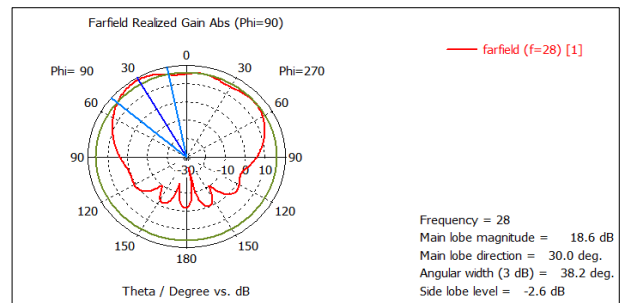

Figure 12: Radiation pattern of (16X1) array antenna

**D. Matching Impedance**

Based on the result, it can be seen that the matching impedance for the 4x1, 8x1 and 16x1 array antennas configurations are perfect. The tradition of using 50 Ω matching impedance comes from a compromise. Because the best power handling capabilities was done in a 30 Ω system, the attenuation was the lowest in a 70Ω system. Therefore, a compromise was achieved at 50 Ω, as shown in Figure 13, 14, and 15.

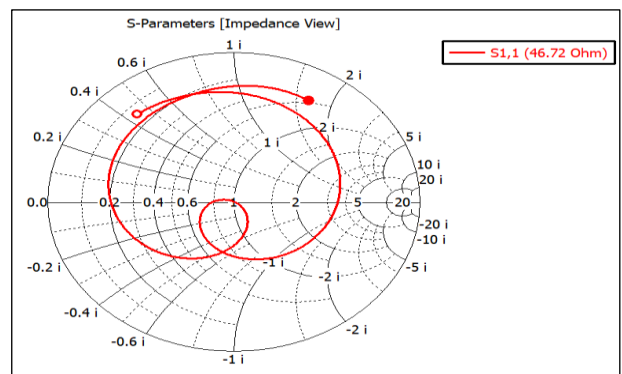

Figure 13: The impedance matching of 4x1 array antenna

VI. CONCLUSION

This paper proposed a 16-element microstrip rectangular array antenna for 5G application. The technique was used to match between the radiating elements and transmission line is quarter wave transformer. The simulated S11 at 28 GHz was -37.254 dB, while the gain was 18.5 dB. Due to enhanced performance, the proposed antenna potentially serves as a good option for 5th Generation Wireless Systems (5G), which requires a high gain and low-profile topology.

ACKNOWLEDGMENT

The authors would like to thank Universiti Teknikal Malaysia Melaka (UTeM) and Ministry of Higher Education for sponsoring this work under research grants: PJP/2017/FKEKK/HI10/S01529.

REFERENCES

- [1] F. Gert, N. Ojaroudiparchin, M. Shen, and G. F. Pedersen, "A 28 GHz FR-4 Compatible Phased Array Antenna for 5G Mobile Phone Applications," pp. 4–8, 2015.
- [2] S. Path, "A Straight Path Towards 5G," pp. 1–29, 2015
- [3] A. Gupta, R. K. Jha "A Survey of 5G Network: Architecture and Emerging Technologies" 10.1109/access.2015.2461602
- [4] T. S. Rappaport et al., "Millimeter Wave Mobile Communications for 5G Cellular: It Will Work !," pp. 335–349, 2013.
- [5] W. Hong, Y. Lee, Y. G. Kim, S. Electronics, R. Dmc, and S. Korea, "Design and Analysis of a Low-Profile 28 GHz Beam Steering Antenna Solution for Future 5G Cellular Applications," pp. 14–17, 2014.
- [6] Outerelo, David Alvarez, et al. "Microstrip Antenna for 5G Broadband Communications: Overview of Design Issues." 2015 IEEE International Symposium on Antennas and Propagation & USNC/URSI National Radio Science Meeting, 2015.
- [7] Muhamad, W.a.w., et al. "Gain Enhancement of Microstrip Grid Array Antenna for 5G Applications." 2016 *URSI Asia-Pacific Radio Science Conference (URSI AP-RASC)*, 2016.
- [8] Ojaroudiparchin, Naser, et al. "8×8 Planar Phased Array Antenna with High Efficiency and Insensitivity Properties for 5G Mobile Base Stations." 2016 *10th European Conference on Antennas and Propagation (EuCAP)*, 2016.
- [9] Stanley, Manoj, et al. "A High Gain Steerable Millimeter-Wave Antenna Array for 5G Smartphone Applications." 2017 *11th European Conference on Antennas and Propagation (EUCAP)*, 2017.
- [10] N. M. Nor, M. H. Jamaluddin, M. R. Kamarudin, and M. Khalily, "Rectangular Dielectric Resonator Antenna Array for 28 GHz Applications," vol. 63, no. February, pp. 53–61, 2016.
- [11] Yu, Low Ching, and Muhammad Ramlee Kamarudin. "Investigation of Patch Phase Array Antenna Orientation at 28GHz for 5G Applications." *Procedia Computer Science*, vol. 86, 2016.

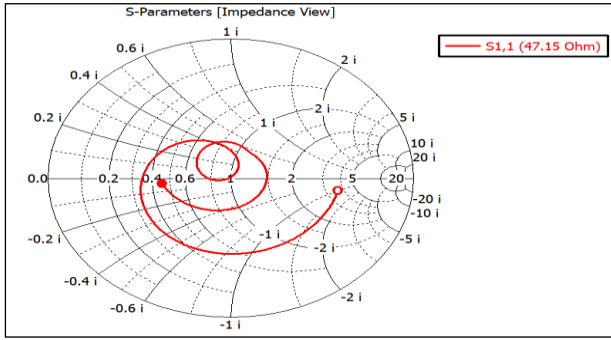

Figure 14: The impedance matching of 8x1 array antenna

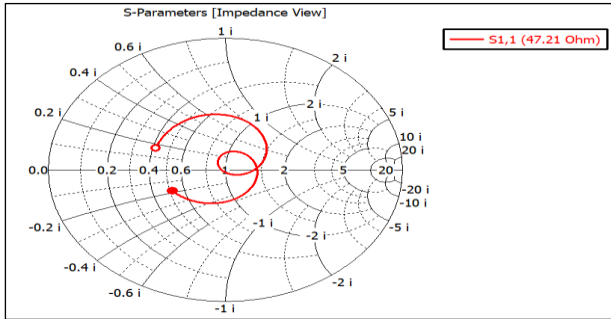

Figure 15: The impedance matching of 16x1 array antenna

V. COMPARISON

It can be observed that the gain is increased by approximately 3 dB whenever the radiating elements are increased. Table 4 shows a comparison of performance of the three designed array antennas.

Table 4  
Comparison of Performance

Configuration	Resonance Frequency	Return Loss, S11 (dB)	Bandwidth (GHz)	Gain (dB)
4x1		-49.038852	1.345	12.14
8x1	28 GHz	-43.0564	2.559	14.91
16x1		-37.25414	1.3851	18.5