

# A Critical Analysis of Fuzzy Logic Controller for Slip Control in Antilock Braking System (ABS)

Fauzal N. Zohedi\*, M.A. Rahmat, Hyreil A. Kasdirin

Center for Robotics and Industrial Automation (CERIA), Universiti Teknikal Malaysia Melaka (UTeM) 76100 Durian Tunggal, Melaka, Malaysia

\*Corresponding author E-mail: [fauzal@utem.edu.my](mailto:fauzal@utem.edu.my)

## Abstract

This project aims at proposing an innovative way to implement the concept of fuzzy logic to an ABS model. The implementation of this project was conducted using simulation of ABS which is a combination from vehicle speed, wheel speed and slip through MATLAB Simulink software. By implementing fuzzy logic to the ABS system, the fuzzy logic can facilitate in improving the ABS abilities. The ABS model is developed and fuzzy logic controller is implemented to the model. The performance of the Fuzzy ABS is analyzed. The result shows that the fuzzy logic controller can facilitates the performance of the ABS by reducing the stopping time and maintaining the slip value near to 0.2.

**Keywords:** Antilock Braking System (ABS); Fuzzy Logic Controller.

## 1. Introduction

Anti-lock braking system or anti-skid braking system (ABS) is one of an important safety technologies used in high end cars and trucks which became a mandatory feature for vehicles in the US and Europe [1]. ABS worked when driver brake very heavily, suddenly or in slippery conditions. The forces exerted by the brakes can be powerful enough to cause the tire to break traction with the road [3]. Other than that, according to [1], the wheels will stop spinning and lock up as the momentum of the vehicle will cause it to continue moving. Australian study by Accident Research Centre, Monash University in 2004 found that ABS reduced the risk of multiple vehicle crashes by 18%. Other than that, ABS reduced the risk of run-off-road crashes by 35% [4].

An ABS contains a series of sensors that can monitor how fast each wheel is rotating. The system is automatically activated to prevent the wheels from locking up. This condition will happen if the system detect a wheel has suddenly stop from spinning. Normally, wheels can be locked up when the driver applied heavy pressure to the brake pedal. When tire triggered, ABS can releases and reapplies brake rapidly around 15 times a second. So, this can prevent the wheels from locking up, helping maintain grip and consequently control. If this happens, the brake pedal will vibrate or pulse rapidly under driver foot.

To design an ABS is a very challenging task considering the fact that it is time varying and highly non-linear system. There are two things in ABS that are highly non-linear and time varying between them, one of it is the contact between the tires and the road surface (slip) and the dynamics of the whole vehicle and the features of key components in ABS such as valves, brake chambers and brake pads. All of this are non-linear and time varying system that difficult to design. Even though a linear model can be derived through a simplification, it is less precise, thus the use of some advanced control strategy is needed. These two things in ABS will affect the time taken to stop and stopping distances of a vehicle.

## 2. Anti-Lock Braking System

A single hydraulic assembly is grouping from the master cylinder, hydraulic booster, and ABS hydraulic circuitry. All of these parts have their own functionality, for example; wheel speed sensor is to transmit a signal of impending wheel lockup to the logic control. It will provide signals to a modulator to decrease the brake line pressure. After that, it will make the wheel to be released and rotational speed to increase again [6]. Figure 1 shows the typical Antilock Braking System.

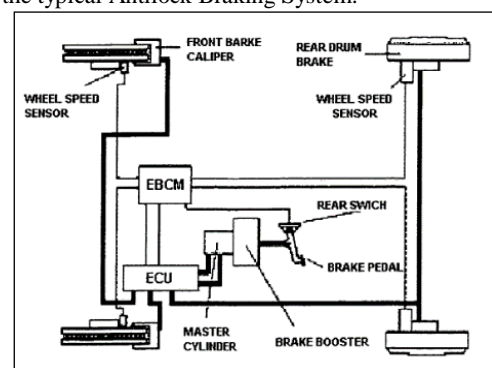

Fig. 1: Typical Antilock Braking System

The performance of an antilock braking system depends on an identification of the road surface type. At present, there is no available reasonable sensor that can accurately detect the road surface and make the information available to the ABS controller. However, according to [5], the road surface condition and type can be inferred from the deceleration rate comparisons, wheel slip measurements, and vehicle braking pressure. One of the main purposes of the ABS is to control the wheel slip so that the road grip coefficient is maximized [7, 8]. With the other meaning, this

strategy leads to minimize the vehicle stopping distance. However, the desired slip range is strongly road surface dependent. It may be referred to that a locked-up wheel generates a decreased braking force, little over those top quality of the accessible bond between tires and road. A locked-up wheel will also lose the vast majority about its ability will support at any lateral force. This might bring about that reduction for vehicle stability and controllability.

The essential motivation behind routine an ABS is to prevent wheel from locking, while to keep those longitudinal slip in an operational reach toward cycling those braking pressure [9]. This will achieve a shorter stopping distance with good directional control and stability during moderate maneuvers.

### 3. ABS Modelling

The vehicle modeling is divided into 3 main parts which are vehicle dynamics, wheel dynamics and braking dynamics of the system. For vehicle dynamic, the equation of motion of the simplified vehicle can be expressed by using Newton's second law:

$$m_t V = -F_t - F_a \tag{1}$$

where  $V$  = vehicle velocity,  $F_t$  = road friction force,  $F_a$  = aerodynamic force acting on the vehicle and  $m_t$  = total mass of the quarter vehicle.

The road friction force is given by Coulomb's law:

$$F_t = \mu N \tag{2}$$

where  $N$  = total normal load and  $\mu$  = road adhesion coefficient. The total mass of the quarter vehicle can be written as

$$m_t = m_{tire} + \frac{1}{4} m_c \tag{3}$$

where  $m_c$  = vehicle mass and  $m_{tire}$  = tire mass. Thus, the total normal load can be expressed by

$$N = m_t g - F_L \tag{4}$$

where  $F_L$  is the longitudinal weight transfer load due to braking and  $g$  = center of gravity height.

The aerodynamic force acting ( $F_a$ ) on the vehicle is proportional to the square of the speed of the vehicle with respect to the air and depends on the vehicle shape and size.

$$F_a = \frac{1}{4} \left( \frac{\rho}{2} C_d A_f V^2 \right) \tag{5}$$

where  $\rho$  = mass density of the air,  $C_d$  = vehicle drag coefficient and  $A_f$  = vehicle frontal area.

For wheel dynamic, the equation of motion at wheel level for the rotational wheel is given by  $\omega$ :

$$J_w \omega = -T_b + F_t R_w \tag{6}$$

where  $J_w$  = wheel moment of inertia,  $\omega$  = wheel speed,  $R_w$  = wheel radius,  $T_b$  = braking torque and  $F_t$  = road friction force.

Braking dynamics of the system is combination of all the speed that involve in each vehicle. The combination of wheel dynamic and speed dynamic will give the equations of the vehicle model that can be expressed as

$$(m_t - \mu(s)m_e) V = -\mu(s)m_t g - \frac{1}{4} \left( \frac{\rho}{2} C_d A_f V^2 \right) \tag{7}$$

$$J_w \omega = -T_b + \mu(s)(m_t g - m_e V) R_w \tag{8}$$

where  $m_e$  is the effective mass.

ABS is actually a closed loop feedback control system in which a sensor monitors the output that is the relative slip ratio and give feeds data to the controller. The controller will adjust to control the brake pressure modulator as necessary to maintain the desired system output either it match with the wheel slip ratio to the reference value or desired value of relative slip. The relative slip equation is expressed as

$$s = 1 - \frac{\omega_w}{\omega_v} \tag{9}$$

where  $\omega_w$  = vehicle angular velocity,  $\omega_v$  = vehicle speed.

The vehicle angular velocity is calculated

$$\omega_w = \frac{T_t - B_t}{I} \tag{10}$$

where  $T_t$  = Tire Torque,  $B_t$  = Braking Torque and  $I$  = Wheel rotational inertia.

The ABS model is developed based of the relative equation. Figure 2 shows the simulation block diagram of ABS model used in the experiment.

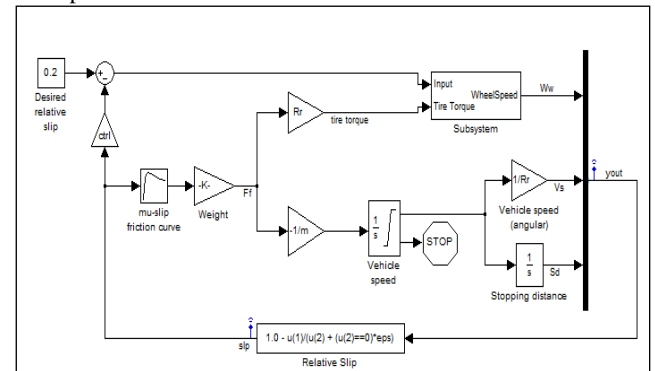

Fig. 2: Simulation of ABS Model

Figure 3 shows the subsystem of the ABS model, which is brake pressure modulator. This is used to simulate braking torque. The hydraulic pressure from braking is multiply with piston area to get the braking torque.

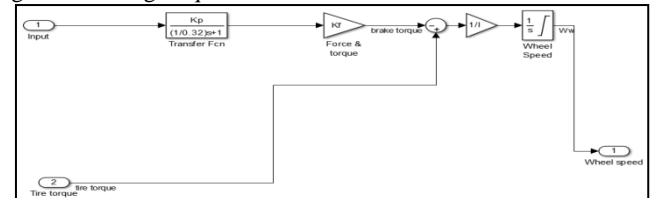

Fig. 3: Brake Pressure Modulator

The parameter used in the model is listed in Table 1.

Table 1: Parameters used in the ABS model

Parameters	Value
Proportional gain ( $K_p$ )	1200
Force and Torque ( $K_t$ )	1
Mass ( $m$ )	50
Wheel radius ( $R_w$ )	1.25
Gain ( $g$ )	32.18

Initial velocity ( $V_0$ )	88
----------------------------	----

The weight of the vehicle for quarter part which is a quarter from the vehicle is calculated in (11), while wheel speed after it through the brake pressure is calculated in (12).

$$K = \frac{(m * g)}{4} \tag{11}$$

$$\omega = \frac{V_0}{Rr} \tag{12}$$

where  $V_0$  = Initial Velocity and  $Rr$  = Wheel radius. Three value of initial velocity are used as a comparative study to the ABS model as shown in Table 2.

**Table 1:** Initial velocity

Initial Condition ( $V_0$ )	1st	2nd	3rd
Value (Rad/s)	87.5	112.5	137.5

These 3 values indicate the low, medium and high initial velocity. The speed value is converted from (rad/s) to (km/h) in (13).

$$v = r\omega \tag{13}$$

where  $v$  = Linear velocity (m/s),  $r$  = Radius (m) and  $\omega$  = Angular Velocity (rad/s). The speeds of wheels are tabulated as shown in Table 3.

**Table 3:** Wheel speed used in the experiment

Wheel Speed (rad/s)	70	90	110
Wheel Speed (km/h)	80.64	103.6	126.72

### 4. Fuzzy Logic Controller

Fuzzy logic controller consists of three basic components which are input signal fuzzification, fuzzy inference mechanism and output defuzzification. Fuzzy inference mechanism handles rules where human experience may easily be injected through linguistic rules. The de-fuzzification block transforms the fuzzy control actions to continuous signals that can be used on physical plant. The knowledge base includes fuzzy sets that are defined on the period of the inputs and outputs of the FLC and rule base, which is constructed from fuzzy implication. The error and error changed for both position and time are scaled using appropriate scaling factors. These scaled input data then converted into linguistic variables which may be viewed as labels of fuzzy sets. Figure 4 shows the block diagram of fuzzy control system.

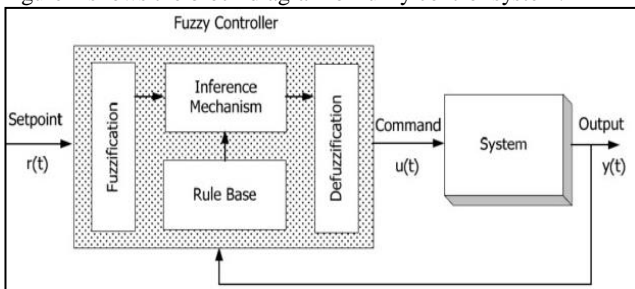

**Fig. 1:** Block diagram of fuzzy control system

#### 4.1. Input Signal Fuzzification

For this project, the fuzzy controller use two inputs which are slip error and slip change rate. The slip error indicate the target error while slip change rate indicate the deceleration of the vehicle changes with respect to time. Fuzzy set uses a common function such as triangular, trapezoidal, Gaussian and many more that were called as membership function to support membership value of its element. In this project, triangular shape is being used for both input. 1<sup>st</sup>, 2<sup>nd</sup> and 3<sup>rd</sup> parameters is used to mention the point

of the triangle. The rules used for comparison purpose are as follow.

- i. 3x3 rules
- ii. 5x5 rules
- iii. 7x7 rules

##### 4.1.1. 3x3 Rule

In 3x3 rule, there is 3 membership function were namely as:

- |                     |                   |
|---------------------|-------------------|
| Slip error:         | Slip change rate: |
| Z = zero            | N = negative      |
| PS = positive small | Z = zero          |
| PB = positive big   | P = positive      |

The range and parameter between the membership function has been adjusted as Table 4. The difference between each point of parameter is 0.75 and the range for parameter 1st to parameter 3rd is from 0 to 3.

**Table 2:** 3x3 slip error input

Name	Parameters		
	1st	2nd	3rd
Z	0	0.75	1.5
PS	0.75	1.5	2.25
PB	1.5	2.25	3

Table 5 shows the 3x3 rate of slip changes. The difference between each point of parameter is 0.75 and the range for parameter 1st to parameter 3rd is from -1.5 to 1.5.

**Table 5:** 3x3 rate of slip error changes

Name	Parameters		
	1st	2nd	3rd
N	-1.5	-0.75	0
Z	-0.75	0	0.75
P	0	0.75	1.5

##### 4.1.2. 5x5 Rules

In 5x5 rule, there is 5 membership function were namely as:

- |                        |                      |
|------------------------|----------------------|
| Slip error:            | Slip change rate:    |
| Z = zero               | NS = negative small  |
| PS = positive small    | Z = zero             |
| PO = positive optimum  | PS = positive small  |
| PB = positive big      | PM = positive medium |
| PTB = positive too big | PB = positive big    |

The range and parameter between the membership function has been adjusted as Table 6. The difference between each point of parameter is 0.5 and the range for parameter 1st to parameter 3rd is from 0 to 3.

**Table 6:** 5x5 slip error input

Name	Parameters		
	1st	2nd	3rd
Z	0	0.5	1
PS	0.5	1	1.5
PO	1.5	1.5	2
PB	1	2	2.5
PTB	2	2.5	3

Table 7 shows the 5x5 rate of slip changes. The difference between each point of parameter is 0.5 and the range for parameter 1st to parameter 3rd is from -1.5 to 0.5.

**Table 7:** 5x5 rate of slip error changes

Name	Parameters		
	1st	2nd	3rd
NS	-1.5	-1	-0.5
Z	-1	-0.5	0
PS	-0.5	0	0.5
PM	0	0.5	1

PB	0.5	1	1.5
----	-----	---	-----

4.1.3. 7x7 Rules

In 7x7 rule, there is 7 membership function were namely as:

- |                          |                     |
|--------------------------|---------------------|
| Slip error:              | Slip change rate:   |
| Z = zero                 | NL = negative large |
| VS = very small          | NS = negative small |
| TO = too small           | Z = zero            |
| STO = small than optimum | TS = too small      |
| O = optimum              | O = optimum         |
| TL = too large           | TL = too large      |
| VL = very large          | VL = very large     |

The range and parameter between the membership function has been adjusted as Table 8. Where the difference between each point of parameter is 0.375 and the range for parameter 1st to parameter 3rd is from 0 to 3.

Table 3: 7x7 slip error input

Name	Parameters		
	1st	2nd	3rd
Z	0	0.375	0.75
VS	0.375	1.75	1.125
TS	0.75	1.125	1.5
STO	1.125	1.5	1.875
O	1.5	1.875	2.25
TL	1.875	2.25	2.625
VL	2.25	2.625	3

Table 9 shows the 7x7 rate of slip changes. The difference between each point of parameter is 0.375 and the range for parameter 1st to parameter 3rd is from -1.5 to 1.5.

Table 9: 7x7 rate of slip error changes

Name	Parameters		
	1st	2nd	3rd
NL	-1.5	-1.125	-0.75
NS	-1.125	-0.75	-0.375
Z	-0.75	-0.375	0
TS	-0.375	0	0.375
O	0	0.375	0.75
TL	0.375	0.75	1.125
VL	0.75	1.125	1.5

4.2. Fuzzy Inference Mechanism

Fuzzy inference is the process of formulating the mapping from a given input to an output using fuzzy logic. For this project, IF-THEN rules have been decided to diagnose between input and output of the variables. While, the connective between error slip and rate of change of slip has been decided by using OR that interpreted as interconnection operation.

4.2.1. 3X3 Rules

Rules for 3x3 have been created using the combination membership function that was developed between (Z, PS and PB) and (N, Z and P). Table 10 shows the fuzzy inference mapping for 3x3 rules:

Table 10: Fuzzy inference mapping for 3x3 rules

Slip Error \ Change of Error	N	Z	P
Z	P	P	Z
PS	P	P	P
PB	N	N	N

4.2.2. 5X5 Rules

Rules for 5x5 has been created by using the combination membership function that was developed between (Z, PS, PO, PB and

PTB) and (NS, Z, PS, PM and PB). Table 11 shows the fuzzy inference mapping for 5x5 rules.

Table 11: Fuzzy inference mapping for 5x5 rules

Slip Error \ Change of Error	NS	Z	PS	PM	PB
Z	PB	PB	PB	PS	Z
PS	PB	PB	PS	PS	NS
PO	PS	Z	Z	NS	NB
PB	NS	NS	NS	NB	NB
PTB	NS	NS	Z	NB	NB

4.2.3. 7X7 Rules

Rules for 7x7 has been created by using the combination membership function that was developed between (Z, VS, TS, STO, O, TL and VL) and (NL, NS, Z, TS, O, TL and VL). Table 12 shows the fuzzy inference mapping for 7X7 rules.

Table 12: Fuzzy inference mapping for 7x7 rules

Slip Error \ Change of Error	NL	NS	Z	TS	O	TL	VL
Z	PL	PL	PL	PL	PM	PS	Z
VS	PL	PL	PM	PM	PS	PS	NS
TS	PL	PM	PM	PS	PS	NS	NS
STO	PM	PS	NM	NL	NL	NL	NM
O	NS	NS	NM	NM	NL	NL	
TL	NS	NS	Z	NM	NL	NL	
VL	NS	NS	NS				

4.3. Output Defuzzification

Defuzzification is the process to produce a result or a crisp value in fuzzy logic. By given the membership functions and fuzzy sets, the defuzzification can process and associated between them. The result of the fuzzy sets that sense in an output will be sent to the plant of the system. The block diagram of ABS model with fuzzy logic controller is illustrated as Figure 5. The desired relative slip is selected to be 0.2 for the maximum friction force and minimum stopping distance. [10]

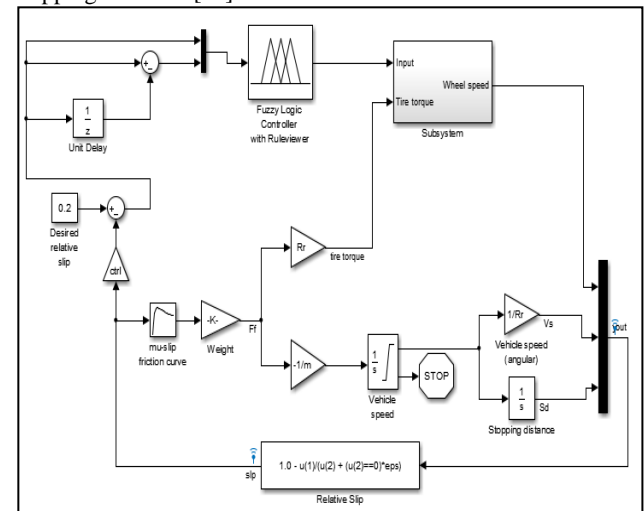

Fig. 5: ABS model with fuzzy logic controller

5. Results and Discussion

This project compared the skidding occurrence when without ABS, with standard ABS and with ABS and fuzzy logic controller. The braking without standard ABS and ABS standard model is being simulated and analyzed in term of wheel speed, time taken to stop and the relative slip. Number of ripple is also calculated to represent the drastic change of wheel speed when ABS activated. Then, the fuzzy logic controller is implemented to the

model and the simulation is being run again. The result is recorded and compared with the standard ABS model.

### 5.1. Breaking Without ABS and With ABS

Figure 6a-b show the result of braking without the ABS at vehicle speed 70 (rad/s).

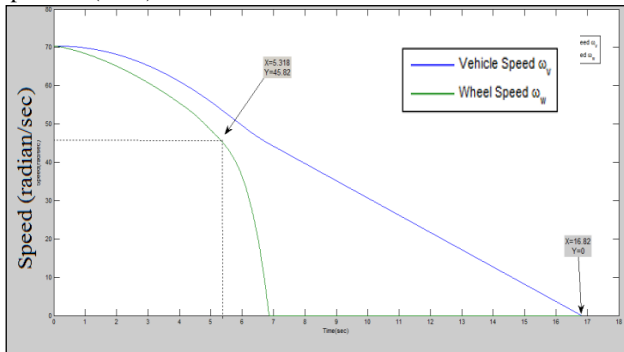

Fig. 6a: Wheel speed Time (s) ABS at 70 (rad/s)

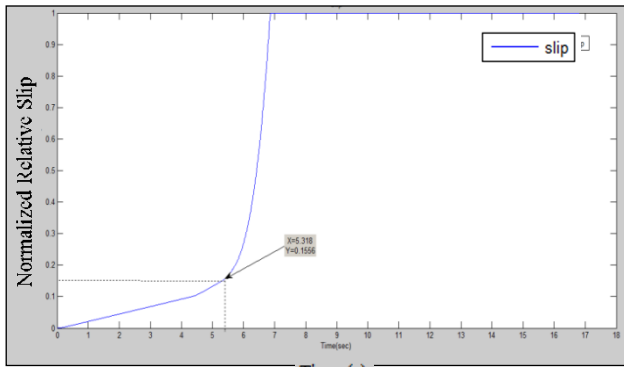

Fig. 6b: Slip without ABS at 70 (rad/s)

The data from Figure 6a-b are tabulated in Table 13:

Table 13: Breaking without ABS at 70 (rad/s)

No. Ripple	Wheel Speed (rad/s)	Wheel Speed (km/h)	Time (s)	Relative Slip
0	70	80.64	0	-
1	45.52	52.78	5.32	0.16
2	0	0	16.82	1

Based on the graph of wheel speed without ABS at 70 (rad/s), the time taken to stop the vehicle was 16.82s. The value of slip was 0.16 before the car stop. The slip value is already at 1 even before the car stop. It shows that the car is sliding on the road for 11s. The wheel speed without ABS also simulated at 90 (rad/s) and 110 (rad/s). The result shows similar graphs as Figure 6a-b, but difference in value as shown in Table 14 and 15.

Table 14: Breaking without ABS 90 (rad/s)

No. Ripple	Wheel Speed (rad/s)	Wheel Speed (km/h)	Time (s)	Relative Slip
0	90	103.68	0	-
1	51.88	59.77	6.06	0.24
2	0	0	21.11	1

Table 15: Breaking without ABS 110 (rad/s)

No. Ripple	Wheel Speed (rad/s)	Wheel Speed (km/h)	Time (s)	Relative Slip
0	110	126.72	0	-
1	68.34	78.73	6.11	0.23
2	0	0	25.00	1

For the 90 (rad/s), the stop time is 21.11s with slip value 0.24 while for 110 (rad/s) the stop time is 25s with slip value 0.23. Similar to the result of wheel speed 70 (rad/s), the 90 (rad/s) and

110 (rad/s) shows the car slide on the road for 13.8s and 17.5s. The high inertia of a sudden stopping will be taken by the passenger inside the car.

Figure 7a-b show the result of braking with the ABS intact at vehicle speed 70 (rad/s).

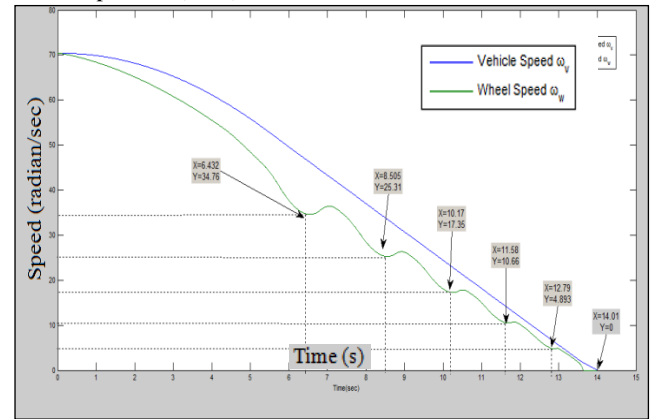

Figure 7a: Wheel speed of standard ABS at 70 (rad/s)

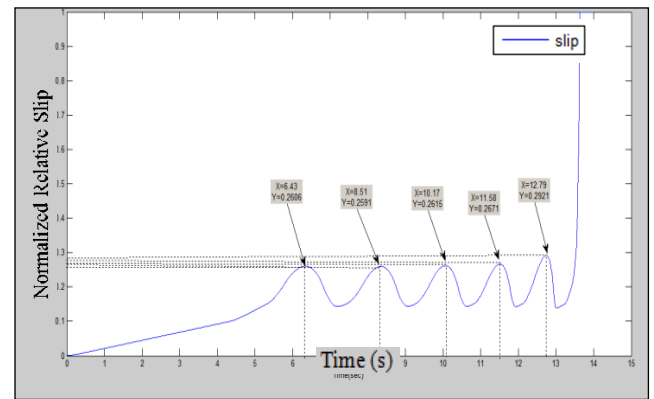

Figure 7b: Slip standard ABS at 70 (rad/s)

The data from Figure 7a-b are tabulated in Table 15:

Table 15: Breaking with standard ABS

No. Ripple	Wheel Speed (rad/s)	Wheel Speed (km/h)	Time (s)	Relative Slip
0	70	80.64	0	-
1	34.76	40.04	6.43	0.26
2	25.31	0	8.51	0.26
3	17.35	19.99	10.17	0.26
4	10.66	12.28	11.58	0.26
5	4.9	5.64	12.79	0.29
6	0	0	14.1	1

Based on the graph of wheel speed standard ABS at 70 (rad/s), the time taken to stop the vehicle was 14.01s. The slip value before the car stop was 0.29 at ripple number 5. The slip of 1 occurs at 13.7 s shows the car slide at about 0.31s.

The wheel speed with ABS are also simulated at 90 (rad/s) and 110 (rad/s). The result shows similar graphs as Figure 7a-b, but difference in value and number of ripple as shown in Table 17-18.

Table 17: Breaking with standard ABS at 90 rad/s

No. Ripple	Wheel Speed (rad/s)	Wheel Speed (km/h)	Time (s)	Relative Slip
0	90	103.68	0	-
1	48.52	55.66	6.68	0.26
2	37.37	43.06	9.06	0.26
3	27.66	31.86	11.15	0.26
4	19.33	22.27	12.90	0.26
5	12.32	14.19	14.37	0.26
6	6.27	7.22	15.67	0.28
7	0	0	17.21	1

**Table 18:** Breaking with standard ABS at 110 rad/s

No. Ripple	Wheel Speed (rad/s)	Wheel Speed (km/h)	Time (s)	Relative Slip
0	110	126.72	0	-
1	62.24	71.70	6.90	0.26
2	50.05	57.66	9.52	0.26
3	38.75	44.64	11.97	0.26
4	29.00	33.41	14.03	0.26
5	20.51	23.63	15.82	0.26
6	13.40	15.44	17.33	0.26
7	7.25	8.35	18.63	0.27
8	0	0	20.44	1

For wheel speed at 90 (rad/s), the stopping time is 17.21s with mean slip 0.263 while for 110 (rad/s), the stopping time is 20.44s with mean 0.261. The sliding rate is at about 0.3s for 90 (rad/s) and 0.6s for 110 (rad/s).

As shown in Figure, the wheel speed and the vehicle speed decrease almost at the same speed of the vehicle. In comparison with the breaking without the ABS, it shows that the time taken to stop is reduced by 2s for 70 (rad/s), 3.9s for 90 (rad/s) and 4.6s for 110 (rad/s).

**5.2. Breaking with ABS and fuzzy logic controller**

The ABS is then implemented with 3x3, 5x5 and 7x7 fuzzy logic controller. The wheel speed is set to 70 (rad/s), 90 (rad/s) and 110 (rad/s). The result of all speed selected is represented by 70 (rad/s) for 3x3, 90 (rad/s) for 5x5 and 110 (rad/s) for 7x7. These are due to the graphs result are similar.

The result for 3x3 fuzzy controller with ABS for 70 (rad/s) is shown in Figure 8a-b.

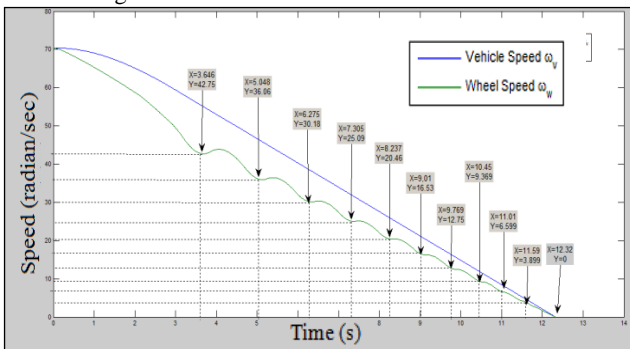

**Fig. 8a:** Wheel speed 3x3 ABS at 70 (rad/s)

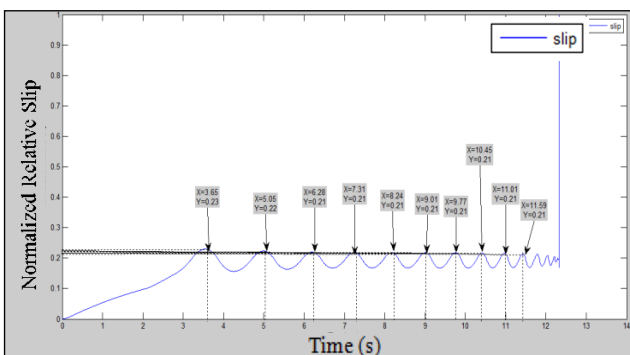

**Fig. 8b:** Slip 3x3 ABS at 70 (rad/s)

Based on the graph of wheel speed 3x3 ABS at 70 (rad/s), the time taken to stop the vehicle was 12.32s. Besides that, the slip that the vehicle take which is the contact between the tire and the road before it fully stop is 0.21. The maximum value of the slip is 0.23 and the minimum value is 0.21.

Figure 9a-b shows the result of ABS with 5x5 fuzzy at 90 (rad/s).

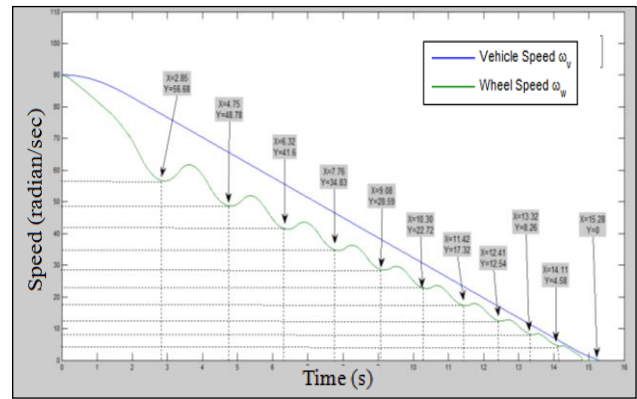

**Fig. 9a:** Wheel speed 5x5 ABS at 90 (rad/s)

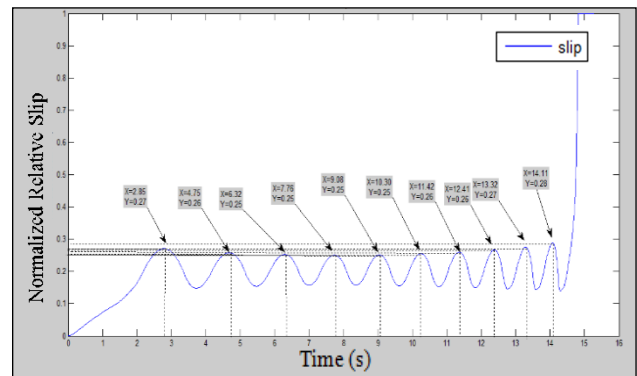

**Fig. 9b:** Slip 5x5 ABS at 90 (rad/s)

From Figure 9a-b, the time taken to stop the vehicle takes 15.28s. Besides that, the slip that the vehicle takes which is the contact between the tire and the road before it fully stops is 0.28. The maximum value of the slip is 0.28 and the minimum value is 0.25.

Figure 10a-b shows the result of ABS with 7x7 fuzzy at 110 (rad/s) speeding.

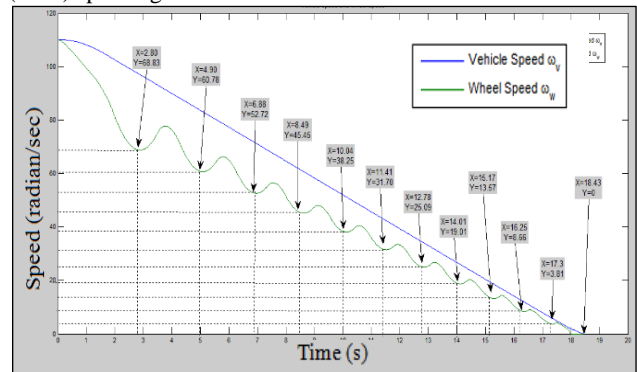

**Fig. 10a:** Wheel speed 7x7 ABS at 110 (rad/s)

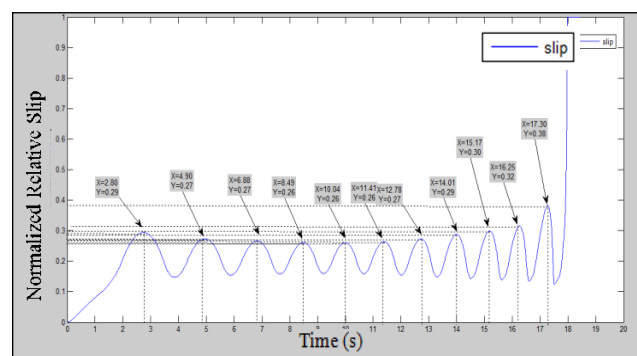

**Fig. 10b:** Slip 7x7 ABS at 110 (rad/s)

Based on the graph of wheel speed 7x7 ABS at 110 (rad/s), the time taken to stop the vehicle takes 18.43s. Besides that, the slip

that the vehicle takes which is the contact between the tire and the road before it fully stops is 0.38. The maximum value of the slip is 0.38 and the minimum value is 0.26.

### 5.3. Summarize result of breaking with standard ABS and breaking with ABS fuzzy

Table 19 shows the summarize result of breaking with standard ABS and breaking with ABS fuzzy; 3x3, 5x5 and 7x7 rules.

**Table 19:** Summarize result of breaking with standard ABS and breaking with ABS fuzzy; 3x3, 5x5 and 7x7 rules

Parameters	No. Ripple	Max. Slip	Min. Slip	Mean Slip	Stop Time (s)
70 rad/s / std. ABS	5	0.29	0.26	0.266	14.1
70 rad/s / 3x3	10	0.23	0.21	0.213	12.32
70 rad/s / 5x5	8	0.28	0.26	0.265	12.18
70 rad/s / 7x7	7	0.34	0.28	0.294	12.23
90 rad/s / std. ABS	6	0.28	0.26	0.263	17.21
90 rad/s / 3x3	12	0.23	0.21	0.216	15.42
90 rad/s / 5x5	10	0.28	0.25	0.26	15.28
90 rad/s / 7x7	9	0.36	0.28	0.293	15.29
110 rad/s / std. ABS	7	0.26	0.27	0.261	20.44
110 rad/s / 3x3	14	0.23	0.21	0.212	18.58
110 rad/s / 5x5	13	0.30	0.24	0.254	18.36
110 rad/s / 7x7	11	0.38	0.26	0.288	18.43

From Table 19, the best stopping time for 70 (rad/s) is 5x5 fuzzy rules which values 12.18s. The same result also occur to 90 (rad/s) and also 110 (rad/s) where the best stopping time is 5x5 fuzzy.

For the slip value, the best slip value for 70 (rad/s) goes to 3x3 fuzzy rules which values 0.213. The same result also happen to 90(rad/s) and 110 (rad/s) where the best slip value goes to 3x3 fuzzy rules.

Figure 11a-c shows the overall result of fuzzy implementation to ABS.

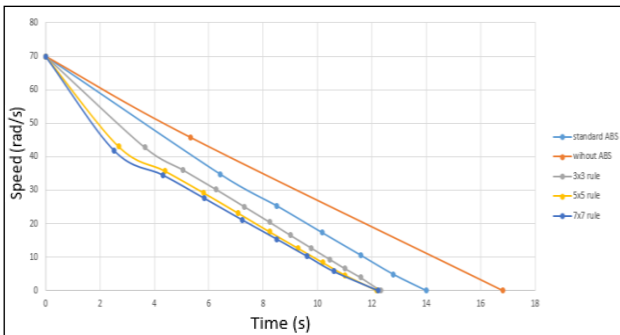

**Fig. 11a:** The overall result of fuzzy implementation to ABS at 70 (rad/s)

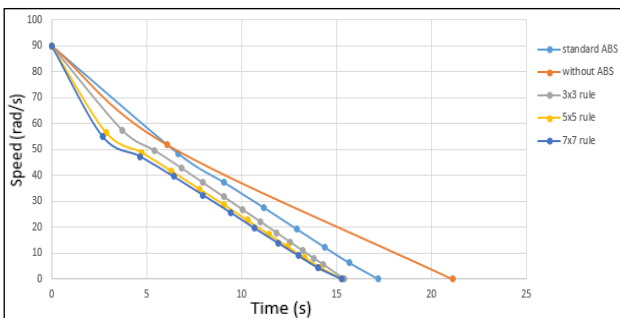

**Fig. 11b:** The overall result of fuzzy implementation to ABS at 90 (rad/s)

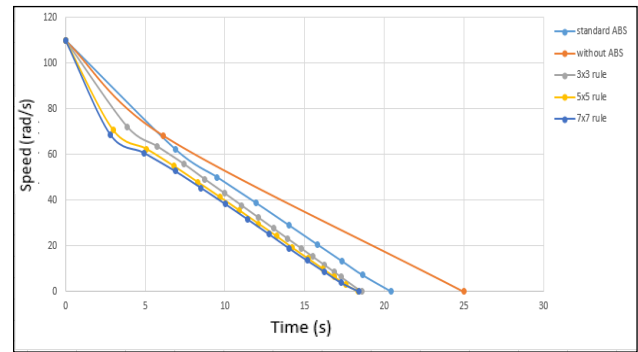

**Fig. 11c:** The overall result of fuzzy implementation to ABS at (110 rad/s)

From the Figure 11a-c, the fuzzy logic controller clearly takes less time to stop the vehicle compare with standard ABS and without ABS. This is done by the controlling of relative slip at 0.2. For vehicle speed at 70 (rad/s), the difference between fuzzy and standard ABS is 1.83 second while for 90 (rad/s) and 110 (rad/s) are 1.93 second and 2.08 second.

Figure 12 shows the mean slip comparison between fuzzy 3x3, fuzzy 5x5 and fuzzy 7x7.

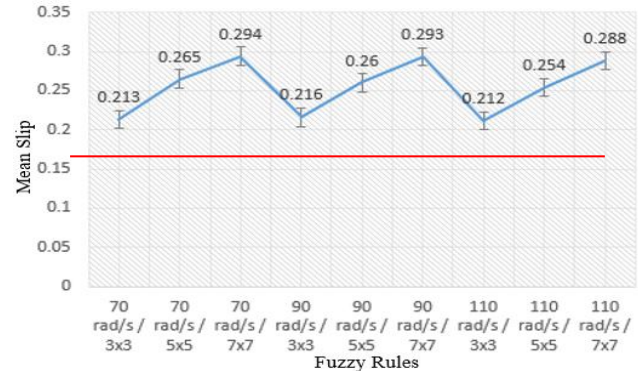

**Fig. 12:** Mean slip comparison between fuzzy 3x3, fuzzy 5x5 and fuzzy 7x7

From Figure 12, it can be clearly seen that 3x3 fuzzy logic shows the best mean value slip. All of the 3x3 fuzzy result 0.21 in average. The lowest performance is from 7x7 fuzzy rules where the average value is 0.29. The middle value is from 5x5 fuzzy rules.

## 6. Conclusion

Fuzzy logic controller is implemented to increase the performance of the ABS at wheel speed 70 (rad/s), 90 (rad/s) and 110 (rad/s). Three fuzzy rules were designed which comprised of 3x3, 5x5 and 7x7. The fuzzy controller result is compared with standard ABS and without ABS. From the comparisons, the best performance of ABS occurs when 3x3 fuzzy rules is implemented. The average means slip of 3x3 fuzzy rules at 0.21 and the stopping time 1.93s less than the standard ABS. This demonstrated that fuzzy logic facilitates the performance of the ABS by reducing the stopping time and maintaining the slip value near to 0.2. Thus, the ABS with fuzzy logic will help the driver to steer while braking heavily and prove to be lifesaving system. This research highlighted that automobile ABS fuzzy control system is worth to be further developed and has bright prospect. For future prospect, the fuzzy controller can be enhanced by implementing to the real ABS and analysis.

## Acknowledgement

Appreciation and gratitude to honorable Universiti Teknikal Malaysia Melaka, UTeM and Ministry of Higher Education for providing the financial assistant through research grant with code

number PJP/2017/FKE-CERIA/S01557, as well as moral support to complete this project successfully.

## References

- [1] P. Pandiaraj and P. Kalaiselvan, "Advanced control systems in two wheeler and finding the collision site of the vehicle using GSM," *International Journal of Research in Engineering and Technology*, 3(3), 628–632, 2014.
- [2] J. A. Oyedepo and A. Folaponmile, "Implementation of a fuzzy logic speed controller for a permanent magnet brushless dc motor drive system," *Journal of Research in National Development*, 9(2), 65–72, 2011.
- [3] V. R. Aparow, K. Hudha, F. Ahmad, and H. Jamaluddin, "Development of antilock braking system using electronic wedge brake model," *Journal of Mechanical Engineering and Technology*, 6(1), 37–64, 2014.
- [4] D. Burton, A. Delaney, S. Newstead, D. Logan and B. Fildes, "Effectiveness of ABS and vehicle stability control systems," Technical report, Royal Automobile Club of Victoria Ltd., 2004.
- [5] A. A. Aly, E.-S. Zeidan, A. Hamed, and F. Salem, "An Antilock-Braking Systems (ABS) Control: A technical review," *Intelligent Control and Automation*, 2(3), 186–195, 2011.
- [6] C. Jain, R. Abhishek, and A. Dixit, "Linear control technique for anti-lock braking system," *International Journal of Engineering Research and Applications*, 4(8), 104–108, 2014.
- [7] D. Antic, V. Nikolic, D. Mitic, M. Milojkovic, and S. Peric, "Sliding mode control of anti-lock braking system: An overview," *Automation Control and Robotics Journal*, 9, 41–58, 2010.
- [8] H. Lin and C. Song, "Design of a fuzzy logic controller for ABS of Electric Vehicle based on AMESim and Simulink," *Proceedings of the International Conference on Transportation, Mechanical and Electrical Engineering*, pp. 779–782, 2011.
- [9] Meritor Wabco, "Anti-lock braking system training program," 1999, [http://www.meritorwabco.com/MeritorWABCO\\_document/tp9738.pdf](http://www.meritorwabco.com/MeritorWABCO_document/tp9738.pdf).
- [10] Ahmed M. El-Garhy, Gamal A. El-Sheikh and Mohamed H. El-Saify "Fuzzy life extending of anti-lock braking system," *Ain Shams Engineering Journal*, 4(4), 735–751, 2013.