

Non-Linear Motorized Prosthetic Hand System with Gradient Descent Tuning Technique

Mohd Hafiz Jali, Rozaimi Ghazali, and Chong Chee Soon

Centre for Robotics and Industrial Automation, Faculty of Electrical Engineering, Universiti Teknikal Malaysia Melaka, Hang Tuah Jaya, 76100, Durian Tunggal, Melaka, Malaysia
Email: { mohd.hafiz, rozaimi.ghazali }@utem.edu.my, halklezt@gmail.com

Ahmad Razif Muhammad

Faculty of Applied Sciences, Ton Duc Thang University, Ho Chi Minh City, Vietnam
Email: a.razifmuhammad@tdtu.edu.vn

Abstract— This paper describes the controller design for a nonlinear motorized prosthetic finger system. This system can be used as a human assistive device for amputee. Since the prosthetic device is worn by human, the accuracy of the system is crucial to avoid unnecessary injury. In addition, the mathematical modelling of the system needs to be developed appropriately to ensure the accuracy of the system. Various types of controllers can be used to obtain a stable nonlinear actuated finger system, such as Proportional Integral (PI), Proportional Integral and Derivative (PID), and Fuzzy Logic controllers. In this work, the Proportional, Integral, and Derivative (PID) controller will be used. The tuning of the PID control parameter is for positioning feedback control of the motor. To improve the transient response performance of the motor, Gradient Descent and Auto-Tuning techniques have been used to obtain the parameters of the PID controller. Comparison between these techniques and the comparison with the previous work is carried out. It is observed from the results, Gradient Descent tuning technique outperforms the Auto-Tuning technique.

Index Terms— prosthetic finger, PID controller, Ziegler-Nichols, gradient descent, tuning technique, transient response

I. INTRODUCTION

Human hand is a complex essence that consists of 27 bones with multitude muscles and tendons that provide large degree of freedom (DOF) during grasping. In addition, each hand has an array of 17000 tactile mechanoreceptors, which is almost impossible to be replaced, especially when it is related to stability and reliability by using the existing technology. The main motivation in this work is to overcome the friction, noise, and disturbance that occur in a plant or during a process. Furthermore, the challenges in designing a control system are uncertain that further encourage a comprehensive analysis that capable to determine the stability and reliability of the system.

The mathematical modelling of a nonlinear motorized prosthetic finger system is first developed before the integration of a control system. In this paper, Lagrange's equation is used to obtain the dynamics of the nonlinear motorized prosthetic finger system. Then, the Proportional, Integral, and Derivative (PID) controller is designed to improve the stability of the system. Parameters of the PID controller are formerly obtained using Auto-Tuning technique, which is latter became initial values in the Gradient Descent optimization technique.

II. RELATED RESEARCH WORKS

A. PID Controller

Previous studies have reported that Proportional, Integral, and Derivative (PID) is a commonly used controller to achieve the desired output response of a particular system. The error between the desired response and the output response is well-known can be minimized using the PID controller. The gains or the parameters of the PID controller is very much affecting the output response. Where try and error method is an easier path to identify the PID control parameter [1]. More advanced meta-heuristic parameters searching method, such as particle swarm optimization (PSO), and Priority-based Fitness PSO (PFPSO) is a recently favourite method to obtain the PID controller gains. However, vast knowledge on artificial intelligence technique is required to perform these meta-heuristic optimization methods [2].

This paper has introduced an integrated design process for designing five-fingered gripper that suitable for smooth motion in experimental and simulation prototype. Then, closed-loop with robust PID controller is applied to the system to control both dynamic and kinematic motions of the five-fingered gripper system. The joint controller is a feedback controller that consists of two terms, which are proportional to velocity and position errors respectively. The kinematic motions of the joint angles for each finger are controlled by using the advanced PID control with auto-tuning technique [3]. A discrete Proportional, Integral, and Derivative control

Manuscript received December 18, 2020; revised March 10, 2021.
Corresponding author: Mohd Hafiz Jali.

technique would greatly reduce the cost since it replacing the complex electronic circuitry [4].

Recent evidence suggested that, grasping accuracy of the robotic hand can be achieved through PID controller optimal parameters that obtained using tuning method. Before the tuning, the position has slight vibration due to the steady-state error and overshoot produced by the motor [1]. The suitable gains of differential (K_d), integral (K_i), and proportional (K_p) values are determined from auto-tuning to achieve a fast response of steady-state without excessive overshoot. By tuning these three suitable values of constant gains in the PID controller, the controller has been found to provide a necessary control action for specific process requirements [3]. At the given time interval, which is sample period (T), a discrete PID controller will read the error signal, calculate it output and control the input given to the motor. Thus, to obtains the desired result, the sample time should always be less than the shortest time constant in the system [4]. The PID controller is setting up for each muscle to track the desired response based on the error [5]. In addition, to obtains an accurate control design, the mathematical model of the system needs to be determined appropriately [6].

B. Summaries of PID Controller Approaches

A survey conducted by Shauri, Salleh, Hadi [1] proved that the PID tuning of finger joints is successfully implemented to reduce the transient response such as rise time, overshoot, settling time, steady-state error, and peak time. The motor will move smoothly and track the position precisely to the target position when the error and the overshoot have been eliminated. Then, the studies stated that each finger of the gripper can be controlled by using the robust control of the PID formulation [3]. The PID controller is working fine, however, it is necessary to make the controller more robust (limit runaway/overflow) in some applications. The accuracy of either derivative (D) or integral (I) factor will be poor if the sample time is short, or even larger than 1 second [4]. The previous study shows that the nonlinear equation is more accurate compared to the linear equation. It can provide a more stable system, and this can affect the control system design [6].

Previous work is conducted to investigate the stability of the scheme in case of imperfect compensation of the gravity term and possibly resort to an adaption mechanism on the system state. Thus, the controller that consists of PD is an action on the position loop, while PI is an action on the force loop along with the gravity compensation and desired contact feedforward force [7].

C. Tuning Method for PID Controller

Numerous tuning methods exist in the tuning of the PID controller. The Ziegler-Nichols is a conventional method used in the tuning of the PID controller and showing a successful response. However, it required effort and took long time to obtain satisfactory response. Ziegler-Nichols method depends on the parameter gain from the step response plant [8]. Some of the researchers used an artificial intelligence approach to tune the PID

controller [9-10]. In the previous paper, the optimization of the PID controller by using the Gradient Descent method has been discussed. By applying the optimization technique from the Gradient Descent method, the performance of positioning tracking shows a significant improvement [11].

The result shows that the tuned PID controller gives a feedback system of good disturbance rejection. However, in general, the compensated system response to a step signal has a high control signal and a high percent of overshoot which may lead to the saturation of the actuator [8]. The evaluation of PID controller performance by using the Gradient Descent technique that applied to the controller has been done. The result from the numerical simulation proves that an optimization technique will produce more precise position trajectory tracking and significant improvement to the controller [11].

III. MODELLING OF PROSTHETIC FINGER

From the previous study, Lagrange Equation is frequently used to derive the model of a prosthetic finger. Thus, the Lagrange Equation has been chosen to model the prosthetic finger system. The dynamic parameters of the prosthetic finger are tabulated in Table I.

TABLE I. DYNAMIC PARAMETERS OF PROSTHETIC FINGER

Symbol	Parameter
l	Length
m	Mass
v	Linear velocity
ω	Angular velocity
g	Gravity (9.81 ms ⁻¹)

The Lagrangian, $L = T - V$ (1)
 where, T represents the kinetic energy, and V represents the potential energy.

Referring to the above forward kinematic equation, the angular velocity is computed using Euler Lagrange formula.

$$\omega = \frac{d\theta}{dt} = \dot{\theta} \quad (2)$$

The Kinetic energy,

$$T = \frac{1}{2} \sum (mV + I\omega^2) \quad (3)$$

$$T = \frac{1}{2} l \dot{\theta}^2 \left(\frac{1}{4} ml + 1 \right) \quad (4)$$

The Potential energy,

$$V = \frac{1}{2} \sum mgy \quad (5)$$

$$V = \frac{1}{2}(mgl \sin \theta) \quad (6)$$

The kinetic energy, T and potential energy, V of the whole system are:

$$L = \frac{1}{2}l\dot{\theta}^2 \left(\frac{1}{4}ml + 1 \right) - \frac{1}{2}(mgl \sin \theta) \quad (7)$$

A. Euler-Lagrange Equation of DC Motor

The electrical and mechanical parts of the DC motor connected to the prosthetic finger can be expressed by,

$$F = \left(\frac{l^2 \ddot{\theta} m}{4} + l\dot{\theta} \right) - \frac{(mgl \cos \theta)}{2} + B\dot{x} \quad (8)$$

For a field-controlled motor, a field circuit has an input voltage V , which is applied to the DC motor. So, rather than control the current directly to a motor, the electric field is varied to control the motor speed.

$$V = \frac{RF}{Ktz} + Kez\dot{x} \quad (9)$$

$$F = \frac{VKtz}{R} - \frac{KeKtz^2}{R} \dot{x} \quad (10)$$

Then, substitute equation (8) into equation (10), which included the mechanical part of the prosthetic finger to the equation.

$$\left(\frac{l^2 \ddot{\theta} m}{4} + l\dot{\theta} \right) - \frac{(mgl \cos \theta)}{2} + B\dot{x} = \frac{VKtz}{R} - \frac{KeKtz^2}{R} \dot{x} \quad (11)$$

$$V = \left[\frac{R}{Ktz} \right] \left(\frac{l^2 \ddot{\theta} m}{4} \right) + \left[\frac{R}{Ktz} \right] (l\dot{\theta}) - \dots \dots - \left[\frac{R}{Ktz} \right] \left(\frac{mgl \cos \theta}{2} \right) + \left[\frac{RB}{Ktz} - Kez \right] \dot{x} \quad (12)$$

The nonlinear equation of position/theta is expressed as:

$$\ddot{\theta} = \frac{Rmgl \cos \theta}{2Ktz} - \frac{RB\dot{x}}{Ktz} - Kez\dot{x} \dots \dots \frac{Rl^2 m}{4Ktz} + \frac{Rl}{Ktz} \quad (13)$$

IV. SIMULATION MODEL

A. Prosthetic Finger with PID Controller

The list of parameters that have been used in the prosthetic finger system is shown in Table II based on the previous paper [12]. The input for the system is voltage, while the output is the angle of the prosthetic finger.

Fig. 1 shows the Simulink Block Diagram of the system. The PID controller has been applied to the system to ensure the system can process smoothly with little disturbance. The PID is a controller that commonly used in the industry, since its capable to reduce the overshoot, settling time, rise time, and steady-state error. In addition, the PID controller will give a better result of the step

response.

TABLE II. LIST OF PARAMETERS APPLIED TO THE SYSTEM

Parameter	Unit	Values
Resistance	R	2.6Ω
Constant torque	K_t	0.007NmA ⁻¹
Constant electric	K_e	0.007Vsrad ⁻¹
Gear ratio	z	15
Radius pulley	r_p	0.02m
Length	L	0.75
Mass	m	1kg
Gravity	g	9.81ms ⁻¹
Friction	B	12.32

The value of K_p , K_i and K_d were firstly obtained from the auto-tuning method. The value was then added to the PID block diagram, and after the system was run, the step response graph will appear as a result. Then, the graph was analyzed.

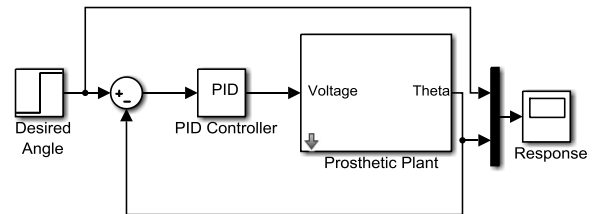

Figure 1. Block diagram of prosthetic finger with PID controller in the MATLAB/Simulink environment.

B. Gradient Descent Tuning Method

The list of parameters that have been used in the prosthetic finger system is shown in Table II based on the previous paper [12]. The input for the system is voltage, while the output is the angle of the prosthetic finger.

Gradient Descent method is an algorithm applied to the system to obtain a minimum point for the particular function. It is to find a maximum point that is nearer to the current result. The value will decrease for each of the iterations that are taking place. The iteration is the number for optimization solver attempt to evaluating the objective function and constraint. The F-count is a function-count by any solver to searching for the maximum or minimum point. All the attempt steps increase the F-count by one at the nearby point, regarding to the algorithm (14) to (17). Then, the Check Step Response Characteristic indicates the result according to the constraint of piecewise linear bounds illustrated in (15). The iteration process had repeated according to the equation (14):

$$X_{i+1} = X_i - \lambda_i \nabla f(X_i) = X_i - \lambda_i g(X_i) \quad (14)$$

At which the $\lambda_i > 0$ satisfies:

$$f(X_i - \lambda_i g(X_i)) = \min f(X_i - \lambda_i g(X_i)) \quad (15)$$

where λ denotes the step size, and gradient operator ∇ of the function $f(X)$. While $g(X_i)$ is the gradient at the current point. By moving to the point where function f taking on a minimum value, the directional derivative is given by:

$$\frac{d}{d\lambda_i} f(X_{i+1})^T \cdot \frac{d}{d\lambda_i} X_{i+1} = -\nabla f(X_{i+1})^T g(X_i) \quad (16)$$

The $\lambda > 0$ is a minor value that leads a small step to the function. An appropriate value for the λ is very significant, the smaller value could increase convergence time, and a higher value may lead to diverging. The appropriate value of λ yield to a stable condition as:

$$f(X_{i+1}) \leq f(X_i) \quad (17)$$

The Gradient Descent method has been proposed as the tuning method for the PID controller. The Simulink block diagram of the PID controller with Gradient Descent tuning methods implemented to the prosthetic finger system is shown in Fig. 2. As for gradient descent method, the check step response characteristic block has been added into the PID block diagram to obtain the result of closed-loop characteristic graph. The gradient descent method is expected to arrive at the minimum point faster than another non-gradient based optimization method [11].

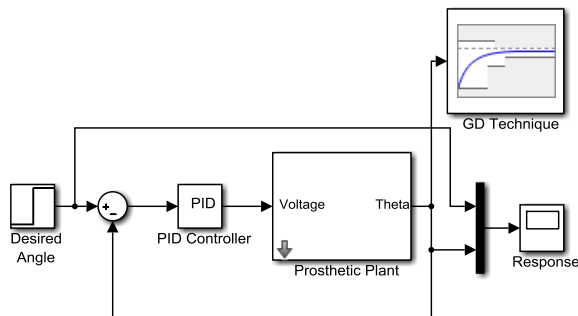

Figure 2. Block diagram of prosthetic finger with gradient descent tuning technique.

V. RESULTS AND DISCUSSION

To observe the system response, step response has been employed to the system in an open-loop circumstance, which will be later implemented in the closed-loop with the synthetisation of the control system. The control system parameters were first obtained using auto-tuning method. Then, the obtained auto-tuning parameters will be used as an initial value in the gradient descent optimization method.

A. Open-Loop System for Prosthetic Finger

Fig. 3 depicts the system response in an open-loop environment. Unstable response indicated in a blue line was obtained, where the desired response denoted in a green line was not tracked. Therefore, a closed-loop design is necessary to achieve the desired response. With the integration of the control system in the closed-loop design, better performance can be achieved.

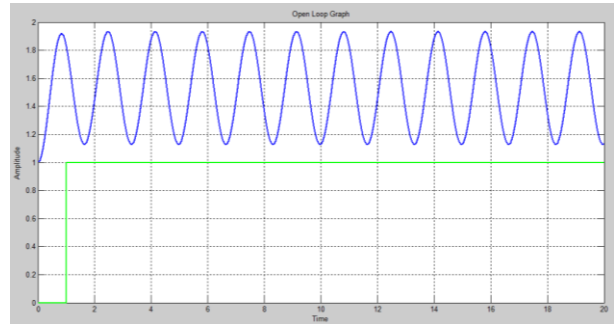

Figure 3. Open-loop response of prosthetic finger.

B. Gradient Descent Tuning Technique

In the gradient descent optimization tuning technique, auto-tuning parameters will be taken as initial values that required to be optimized. Fig. 4 shows the step response by using auto-tuning parameters. It is observed from Fig. 4, poor performance of transient response such as rise time, settling time, overshoot, and steady-state error were achieved. Then, gradient descent tuning technique will be applied to the PID controller to obtain better performance. In this tuning method, the iteration process based on Eq. (14) will take place to obtain a minimum point closed to the desired result.

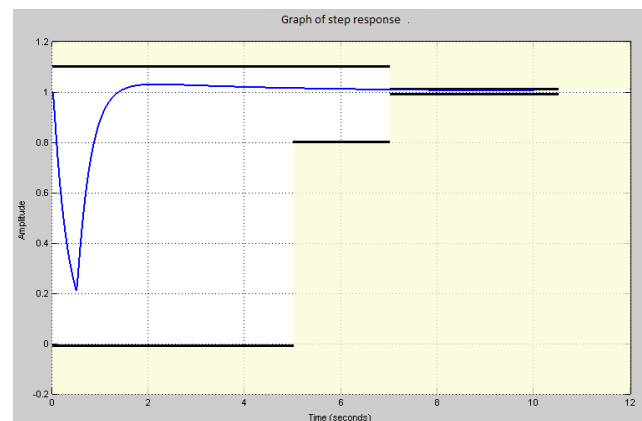

Figure 4. Step response based on auto-tuning.

Three attempts were conducted with different step response bounds, including rise time, % rise, settling time, % settling, overshoot and % undershoot. Numerical data off all the bound were shown in Table III. Smooth and better transient response were obtained after three attempts.

TABLE III. STEP RESPONSE BOUNDS OF ALL THREE ATTEMPTS

Characteristic	1 st attempt	2 nd attempt	3 rd attempt
Rise time	00.6650	00.7650	00.8650
% Rise	90.4870	90.5870	90.6870
Settling time	02.6650	02.6650	02.8650
% Settling	01.0000	01.0000	01.0000
Overshoot	10.0000	10.0000	10.0000
% Undershoot	01.0000	01.0000	01.0000

Figs. 5, 7, and 9 indicate the step response obtain from all three attempts. Then, Figs. 6, 8, and 10 are the optimization report of all three attempts, which including numbers of iterations, F-count, and check step response characteristic.

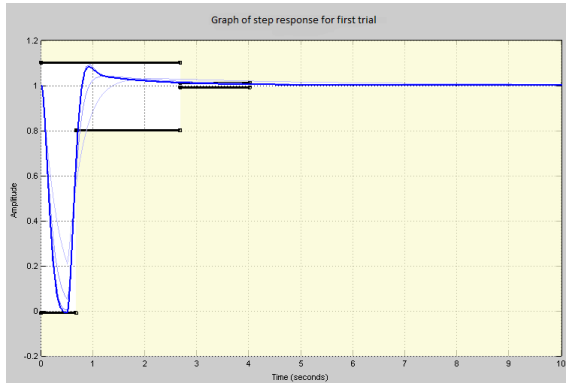

Figure 5. The response of the first attempt.

It is observed from the report in Figs. 6, 8 and 10, the process goes through four to five iterations started from the iteration number zero, and the output responses generated from all the iterations were denoted in light blue line in Figs. 5, 7, and 9.

Iteration	F-count	Check Step Response Characteristics (Upper) (<=0)
0	7	0.2809
1	17	0.1835
2	26	0.0020
3	34	3.1460e-05
4	42	-1.5633e-04

Figure 6. The optimization report of the first attempt.

Since the step response performance of this optimization method interrelated with the step response bounds as discussed earlier, it is believed that different settings produced different performance. Therefore, few more attempts were carried out to observe the performance produced by this optimization method. It is clearly seen in Fig. 6, the overshoot character was eliminated in the second attempt.

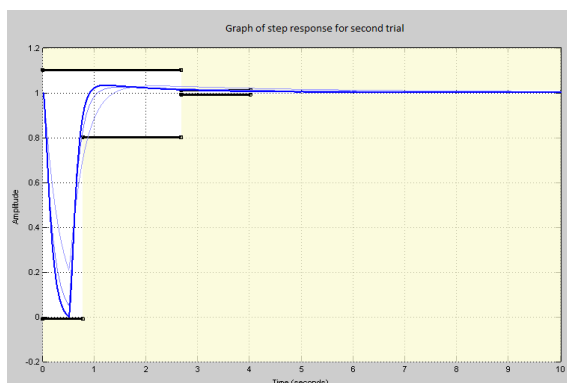

Figure 7. The response of the second attempt.

Based on the report in Fig. 8, four iterations have been taken to obtain the result as illustrated in Fig. 7.

Iteration	F-count	Check Step Response Characteristics (Upper) (<=0)
0	7	0.0967
1	15	0.0048
2	24	4.8520e-04
3	32	3.3340e-04

Figure 8. The second trial optimization process.

In the third attempt by using the setting in Table III, response in Fig. 9 was obtained. Overshoot effect that might causing damage was decreased compared with the second attempt.

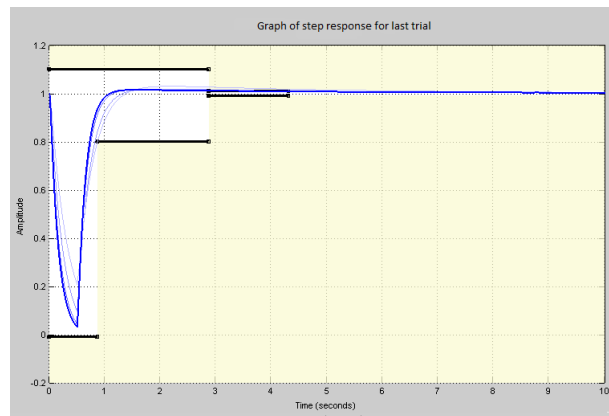

Figure 9. The response of the third attempt.

Each iteration come along with the numbers of iterations, and the check step response characteristic value that was obtained through the equation as discussed earlier.

Iteration	F-count	Check Step Response Characteristics (Upper) (<=0)
0	7	0.0642
1	15	0.0035
2	23	7.5954e-04
3	31	1.7378e-04
4	39	-2.2268e-05

Figure 10. The optimization report of the third.

To compare the output performances of these three attempts, all the results were combined and depicted in Fig. 11. Based on the result, there is a significant finding on the criteria of gradient descent which are a variation of the gradient, a variation of the parameter, function reaches lower bounded and fixed maximum for the number of iteration. These criteria can be used as a reference to determine the best result of the comparison.

So, the graph for the third attempt satisfied the listed criteria.

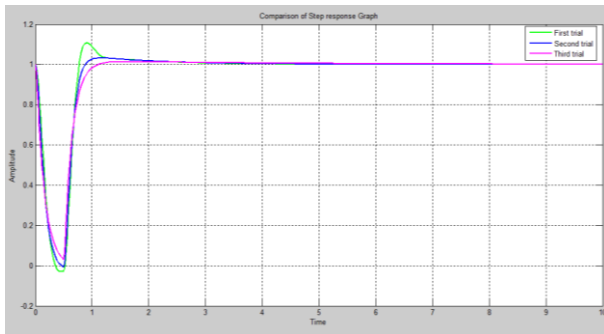

Figure 11. Comparison of all three attempts.

To analyse the output performances of these three attempts, Root Mean Square Error (RMSE) has been used with the numerical data as tabulated in Table IV. It is observed from the data, the first attempt generated highest error, followed by the second, and the third attempt.

TABLE IV. RMSE ANALYSIS OF ALL THREE ATTEMPTS

Attempt	Root Mean Square Error (RMSE)
1 st	4.03403
2 nd	4.03271
3 rd	4.02953

Then, the comparison with the conventional auto-tuning technique was conducted as described in Fig. 12. It can be seen in Fig. 12, the transient response performance of the gradient descent tuning technique is better than the auto-tuning technique.

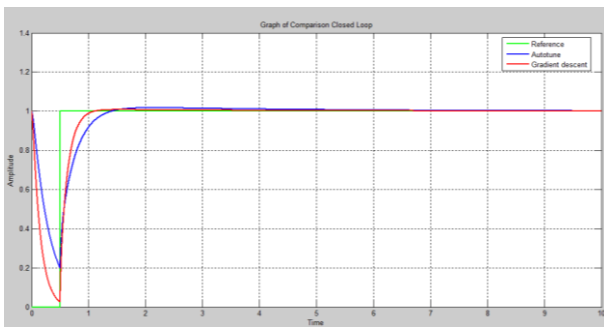

Figure 12. The response between auto tune and gradient descent tuning technique.

Numerical results of RMSE in Table V indicated the gradient descent tuning technique was able to achieved lower error in the tracking of the desired step response.

TABLE V. RMSE OF GRADIENT DESCENT AND AUTO-TUNING TECHNIQUES

Method	RMSE Analysis
Auto Tuning	0.1057330
Gradient Descent	0.0848619

In order to analyse the efficiency of the proposed method, the comparison with the work done in [13], which is the sliding mode controller (SMC) that has been tuned using particle swarm optimization (PSO) algorithm implemented in the same plant has been carried out. The transient response and steady-state error results are tabulated in Table VI.

It is observed from the results, the PID controller tuned using gradient descent method generated less rise time of 1.2665×10^{-4} seconds, settling time of 0.8377 seconds, and steady-state error of 3.1911×10^{-5} degrees. By comparing to the overall data, PID that has been tuned using gradient descent capable of achieving most satisfactory performance.

VI. CONCLUSION

In the past, various types of tuning methods have been proposed in the tuning of the PID controller, such as Ziegler Nichols, auto-tuning, Particle Swarm Optimization (PSO), and Gradient Descent methods. Each of these tuning methods has different requirement in the tuning process. In this paper, the auto-tuning method has been first utilized, which was later compared with the gradient descent tuning technique. Auto-tuning method is a simple tuning method and the performance was not so accurate compared to the others tuning methods. The gradient descent tuning method was later applied and showing better transient response performance for the system. In addition, the Root Means Square Error (RMSE) also demonstrated smaller error of gradient descent compared to the auto-tuning method. As a result, it can be inferred that tuning method playing vital role, and the gradient descent tuning method capable to produce better performance compare to the auto tuning method implemented in a nonlinear motorized prosthetic finger control system.

TABLE VI. TRANSIENT RESPONSE AND STEADY-STATE ERROR

Controller (Tuning Technique)	Transient Response Analysis			
	Rise Time (s)	Overshoot (%)	Settling Time (s)	Steady-state Error (θ)
PID (Auto Tuning)	7.8294×10^{-04}	1.7575	2.6840	7.9761×10^{-05}
PID (Gradient Descent)	1.2665×10^{-04}	1.6714	0.8377	3.1911×10^{-05}
SMC (PSO)	2.212	0.00	3.71	0.00008

CONFLICT OF INTEREST

The authors declare no conflict of interest.

AUTHOR CONTRIBUTIONS

M.H.J. and R.G. conducted the research, analyzed the data, and wrote the paper. C.C. and A.R.M. wrote the paper. All authors had approved the final version manuscript.

ACKNOWLEDGEMENT

The authors would like to thank Universiti Teknikal Malaysia Melaka (UTeM) for the funding thru research grant with code number JURNAL/2019/FKE/Q00045.

REFERENCES

- [1] R. Shauri, N. Salleh, and A. Hadi, "PID position control of 7-DOF three-fingered robotic hand for grasping task," in *Proc. International Conference on Control System, Computing and Engineering (ICCSCCE)*, 2014, pp. 70–74.
- [2] H. I. Jaafar, S. Y. S. Hussien, N. A. Selamat, M. N. M. Nasir, and M. H. Jali, "Analysis of transient response for coupled tank system via conventional and Particle Swarm Optimization (PSO) techniques," *International Journal of Engineering and Technology*, vol. 6, no. 5, pp. 2002-2007, 2014.
- [3] W. Widhiada, T. G. T. Nindhia, and N. Budiarsa, "Robust control for the motion five fingered robot gripper," *Int. J. Mech. Eng. Robot. Res.*, vol. 4, no. 3, pp. 226–232, 2015.
- [4] R. Agrawal, K. Kabiraj, and R. Singh, "Modeling a controller for an articulated robotic arm," *Intell. Control Autom.*, vol. 3, no. 3, pp. 207–210, 2012.
- [5] A. D. Deshpande, J. Ko, D. Fox, and Y. Matsuoka, "Anatomically correct testbed hand control: Muscle and joint control strategies," in *Proc. IEEE International Conference on Robotics and Automation (ICRA)*, 2009, pp. 4416–4422.
- [6] M. Jali, N. Rashid, M. Kamarudin, R. Ghazali, and H. Jaafar, "Linear and nonlinear dynamic modelling of motorized prosthetic hand system," *J. Theor. Appl. Inf. Technol.*, vol. 93, no. 1, pp. 226–232, 2016.
- [7] S. Chiaverini, B. Siciliano, and L. Villani, "Force/position regulation of compliant robot manipulators," *IEEE Trans. Automat. Contr.*, vol. 39, no. 3, pp. 647–652, 1994.
- [8] J. C. Babilio and S. R. Matos, "Design of PI and PID controllers with transient performance specification," *IEEE Trans. Educ.*, vol. 45, no. 4, pp. 364–370, 2002.
- [9] M. H. Jali, M. N. Azam, R. Ghazali, H. I. Jaafar, and Z. H. Bohari, "PID control tuning using PSO for prosthetic hand system," *Int. J. Appl. Eng. Res.*, vol. 11, no. 20, pp. 10274–10280, 2016.
- [10] M. H. Jali, N. E. S. Mustafa, T. A. Izzuddin, R. Ghazali, and H. I. Jaafar, "ANFIS-PID controller for arm rehabilitation device," *International Journal of Engineering and Technology (IJET)*, vol. 7, no. 5, pp. 1589-1597, 2015.
- [11] C. C. Soon, R. Ghazali, H. I. Jaafar, and S. Y. S. Hussien, "PID controller tuning optimization using gradient descent technique for an electro-hydraulic servo system," *J. Teknol. Sci. Eng.*, vol. 77, no. 21, pp. 33–39, 2015.
- [12] M. H. Jali, N. A. Rashid, R. Ghazali, T. A. Izzuddin, and E. S. A. Aziz, "Parameter estimation technique of nonlinear prosthetic hand system," *Int. J. Eng. Technol.*, vol. 8, no. 5, pp. 2161–2168, 2016.
- [13] M. H. Jali, T. A. Izzuddin, R. Ghazali, C. C. Soon, and F. N. Zohedi, "Robust controller design with particle swarm optimization for nonlinear prosthetic hand system," *Int. J. Mech. Eng. Robot. Res.*, vol. 6, no. 5, pp. 406–412, 2017.

Copyright © 2021 by the authors. This is an open access article distributed under the Creative Commons Attribution License (CC BY-NC-ND 4.0), which permits use, distribution and reproduction in any medium, provided that the article is properly cited, the use is non-commercial and no modifications or adaptations are made.



Mohd Hafiz Jali received the B.Sc. degree in electrical and electronic engineering with first class honours from MARA University of Technology (UiTM), Malaysia in 2007 and completed his Master engineering studies with distinction in Industrial Electronics and Control at University of Malaya (UM), Malaysia. He was with the automotive company, Proton Sdn. Bhd from 2007 to 2010 as a Test Engineer under the Complete Vehicle Testing (CVT) department. In 2012, he was appointed as a Lecturer at Universiti Teknikal Malaysia Melaka (UTeM), Malaysia. His teaching and research interests are in the general area of control, artificial intelligence and robotics.



Rozaimi Ghazali received his B. Eng degree in Electrical Engineering (Instrumentation and Control) in 2008 and Ph. D in Electrical Engineering in 2013 from Universiti Teknologi Malaysia (UTM). Currently, he is a senior lecturer at Technical Universiti Teknikal Malaysia Melaka (UTeM) and his interests involve system identification and robust controller design.



Chong Chee Soon received the B. Eng degree in Electronic Engineering (Mechatronics) from Universiti Tun Hussein Onn Malaysia (UTHM) in 2014. Currently, he pursues the Master level in Electrical Engineering at Universiti Teknikal Malaysia Melaka (UTeM).



Ahmad Razif Muhammad received Bachelor of Engineering in 2012, Master of Philosophy in Electrical Engineering in 2015 and Doctor of Engineering in 2019 from Universiti Malaya. Currently he holds Post-Doctoral position in Faculty of Applied Sciences, Ton Duc Thang University, Ho Chi Minh City, Vietnam.