

Active cooling photovoltaic with IoT facility

Muhammad Nizam Kamarudin¹, Sahazati Md. Rozali², Mohd Saifuzam Jamri³

^{1,3}Center for Robotics and Industrial Automation, Faculty of Electrical Engineering, Malaysia, Universiti Teknikal Malaysia Melaka, Melaka, Malaysia

²Faculty of Electrical and Electronic Engineering Technology, Universiti Teknikal Malaysia Melaka, Melaka, Malaysia

Article Info

Article history:

Received May 10, 2021

Revised Jun 30, 2021

Accepted Jul 22, 2021

Keywords:

Active cooling

Energy

Internet of Things

Photovoltaic

Solar systems

ABSTRACT

Harvesting energy from the sun makes the photovoltaic (PV) power generation a promising technology. To obtain a consistent state of charge (SOC), consistent energy must be harvested and efficiently directed to the battery. Overcharging or undercharging phenomena decreases the lifetime of the battery. Besides, the effect of irradiance toward solar in term of sunlight intensity effects the efficiency and hence, sluggish the SOC. The main problem of the solar panel revealed when the temperature has increased, the efficiency of solar panel will also be decreased. This manuscript reports the finding of developing an automatic active cooling system for a solar panel with a real time energy monitoring system with internet-of-things (IoT) facility. The IoT technology assists user to measure the efficiency of the solar panel and SOC of the battery in real time from any locations. The automatic active cooling system is designed to improve the efficiency of the solar panel. The effectiveness of the proposed system is proven via the analysis of the effect of active cooling toward efficiency and SOC of photovoltaic system. The results also tabulate the comparative studies of active-to-passive cooling system, as well as the effect of cooling towards SOC and efficiency of the solar panel.

This is an open access article under the [CC BY-SA](https://creativecommons.org/licenses/by-sa/4.0/) license.



Corresponding Author:

Muhammad Nizam Kamarudin
Faculty of Electrical Engineering
Universiti Teknikal Malaysia Melaka (UTeM), Hang Tuah Jaya
76100 Durian Tunggal, Melaka, Malaysia
Email: nizamkamarudin@utem.edu.my

1. INTRODUCTION

In 1839, Alexandre-Edmond Becquerel conducted his first research discussing the effect of the solar panel [1]. Subsequently, the first modern solar cell that was made of silicon was fabricated by Russel Ohl [2], where he has filed a patent under the name of "Light sensitive device" in 1941 [3], [4]. Nowadays, solar energy has become the easiest available source of energy for its advantages in reducing carbon dioxide emission and preventing climate change. Solar energy is currently extensively being utilized by residential place and being used widely by various countries. The first-generation solar cells are formed on silicon wafers. The silicon wafer-based technology can be classified into two groups: a mono-crystalline silicon solar cell and poly-crystalline silicon solar cell [5]. Second-generation solar cells are most of the thin film solar cells. They are known to be more economical as compared to the first-generation silicon wafer solar cells. Thin-film solar cells have a very thin light absorbing layers than Silicon-wafer, that measured in the order of 1 μm thickness. Whereas silicon-wafer cells have a light absorbing layer up to 350 μm thick. Research in solar energy is getting blossom and offering a multidisciplinary power system study including power system stability [6], power system control [7], and power system protection [8].

Solar cells are sensitive towards temperature through their semiconductor material parameters. The band gap of a semiconductor is reduced as the temperature increases. As such, the open-circuit voltage decreases resulting in the declining of the solar cell efficiency. The suggested operating temperature according to standard test conditions (STC) is 25 °C [9]. Figure 1 shows the relationship between PV cell Power (in Watt) versus Voltage (in Volt) curves for different temperature setting [10].

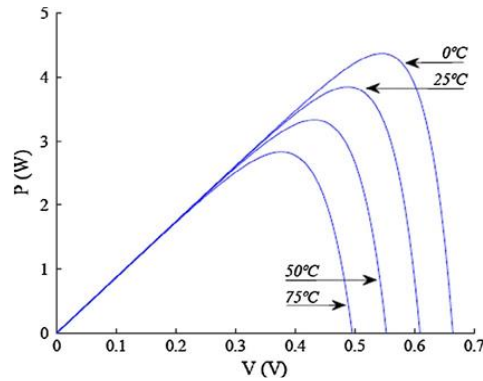

Figure 1. PV module characteristic curves plotted for different temperatures

Irradiance is a measure of power density of sunlight in watt per meter square. In other words, irradiation is the measure of energy density of sunlight. The PV curve with respect to irradiation is shown in Figure 2. The figure shows that a maximum power point can be observed through a standard illumination of 1000 W/m² [11].

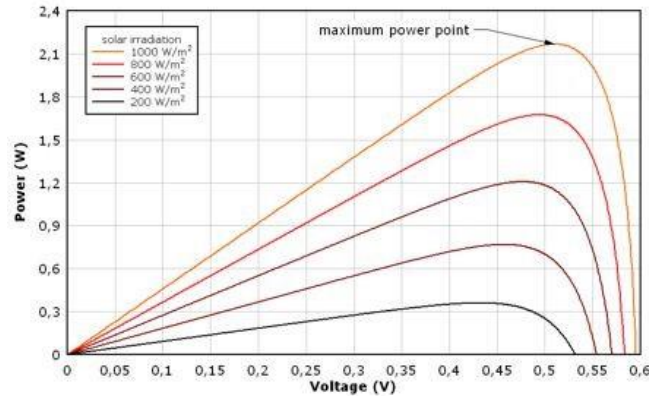

Figure 2. Graph of the PV cell Power (W) against Voltage (V) curves with different solar radiations

As temperature and irradiance dependency are both crucial to the performance of solar energy, the need for cooling system is a must to adhere to the STC temperature [12]. As such, there are many cooling techniques available in the literature. For instance, a passive air-cooled system [13], [14], closed loop water cooling system [15], air-cooled system [16], and water sparkling system [17] as shown in Figure 3 respectively. Passive air-cooled system uses heat sinks as a heat transfer that can transfer the heat from a high thermal energy to a low temperature side and then cooled-up by the surrounding air. There are three methods to transfer heat from one spot to another, namely a convection, radiation, and conduction [18].

In the closed loop water cooling system, the pipeline with a thickness of around 20 mm pipeline is attached to the rear side of the PV module. The reservoir supplies water to the cooling panel with an insulation pipe with thickness of 10 mm. The pump is connected to the outlet tank for circulating and to regulate the water flow inside the cooling panel and bring the warm water to the collector.

Simple air-cooled system can be constructed via the brushless DC motor fan. More advanced active cooling system can be formulated based on the force convection induced by the fans-array as the cooling

mechanism. The fan installed at the back side of PV panel extracts the energy from the panel and convert it to heat, and afterward cool-up the panel. In the literature therein, it is proven that air cooling system can reduce the temperature to improve the efficiency of the PV module [19].

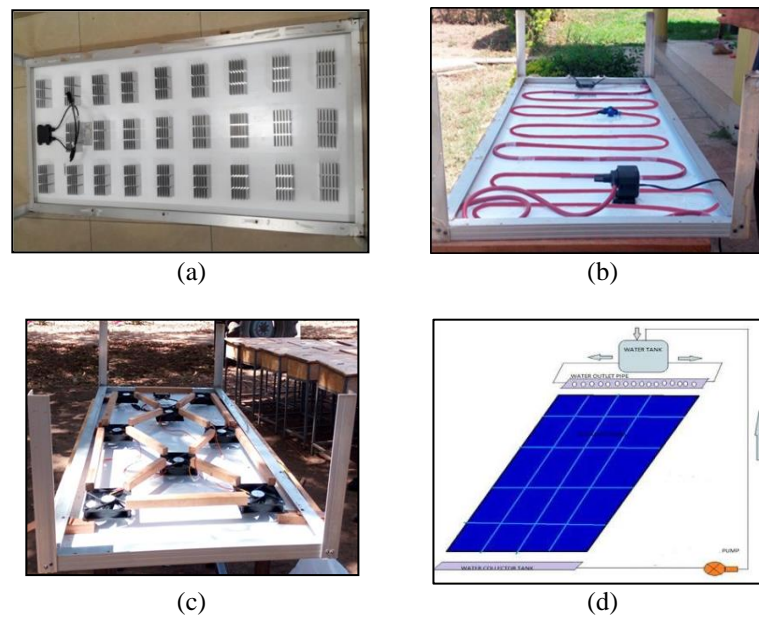

Figure 3. These figures are; (a) 150 W solar panel with heat sinks; (b) closed loop water cooling system; (c) air cooling system using DC motor fan; (d) hybrid active cooling system

Water sprinkling systems cool the irradiation surface area of PV solar with liquid (mostly water). The cooling period is highly depending on the PV material [20]. The most popular method of the active cooling system is the hybrid photovoltaic/thermal (PV/T) solar for cooling the photovoltaic panels. The hybrid system consists of a solar photovoltaic panel combined with a cooling system. Water is circulated around the irradiation surface of PV panels for cooling the solar cells. The warm water leaving the panels is pumped back to the reservoir and the process is repeating. This hybrid system solves the problem of overheating due to uncontrolled solar radiation and can maintain the efficiency of the panels using least possible amount of water.

Based on brief literature survey in this section, the cooling systems have shown their effectiveness to improve the PV performance despite irradiance and temperature changes. However, the augmentation with IoT facility is rather hard to obtain in literature survey. In this advanced technological era with I.R 4.0, the system integration with IoT has become necessity to mankind living style [21], as well as to improve process, product, and quality [22]-[24]. As such, an IoT-based active cooling technique is developed and the outcome has been reported in this manuscript. This manuscript consists of 4 sections including the introduction. Research method in section 2 explains the chronological of research and development. Section 3 discusses the results and observation. While chapter 4 concludes the finding.

2. RESEARCH METHOD

As temperature and irradiance dependency are both crucial to the performance of solar energy, the aims of research then can be defined appropriately. Thus, work reported in this manuscript embarks into three (3) main objectives. Firstly, a solar energy monitoring system using IoT technology is developed. The purpose is to measure the efficiency of the solar panel and state of charge (SOC) of the battery. Secondly, an automatic active cooling system is designed to improve the efficiency of the solar panel. The main reason that embarks into this development is because the increment of temperature may decrease the efficiency of solar panel. Lastly, the effect of active cooling towards the efficiency and SOC are analysed. Plus, the comparative studies of active-passive cooling system are also reported in the conclusion.

2.1. System configuration

Block diagram in Figure 4 shows the overall system configuration for the active cooling photovoltaic with IoT facility developed in this manuscript. The diagram portrays the overall idea of the system. The methodology to develop an active cooling photovoltaic with IoT involves 4 phases involving the photovoltaic interfacing and wiring, developing a cooling system, programming the micro-controller, and developing the IoT facility. The system configuration is depicted in Figure 5. The components and apparatuses are including sensory elements / modules, micro-controller, photovoltaic, solar charger controller, voltage regulator module, ESP8266 Wi-Fi module, relay module, lead acid battery with specification 12V 7Ah, and 12VDC water pump. The sensor elements are the voltage sensor module, current sensor module, intensity sensor, and the temperature sensor DHT 22. The voltage cum current sensor senses the voltage and current from a 20W solar panel. The temperature sensor and intensity sensor detect the surrounding temperature and high intensity respectively. The additional features come from the WiFi module linking the system to the blynk applications for human interface. Whereas the cooling system mainly involving the mechanical structure consisting of reservoir, direct current pump, and water piping. Application software for the system is developed using ATmega328P in Arduino Uno micro-controller. The specification for the ATmega328P microcontroller circuitry is tabulated in Table 1 [25]. In brief, the sensory elements send alert signal to the micro-controller. Upon processing with decision making, the micro-controller will decide whether to activate or de-activate the cooling system. Plus, the micro-controller also provide data to the human interfacing system via Wifi-module according to the current temperature and intensity conditions.

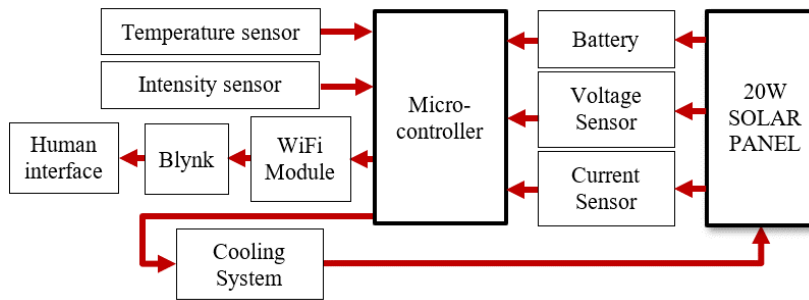

Figure 4. System block diagram

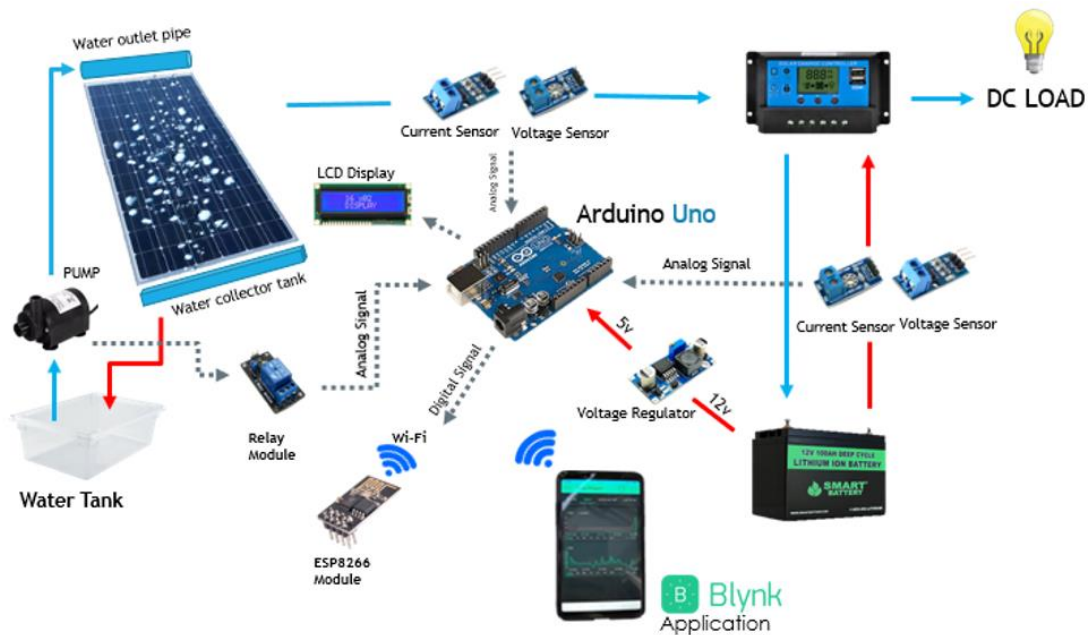

Figure 5. System configuration

Table 1. Specifications for ATMEGA328P circuitry

ATmega328P circuitry	Rating values
Operating Voltage	5V
Input Voltage	7 - 12V
Input Voltage (limit)	6 - 20 V
Digital I/O Pins	14
PWM Digital I/O Pins	6
Analog Input Pins	6
DC Current per I/O Pin	20mA
DC Current for 3.3V Pin	50mA
Flash Memory	32KB
SRAM	2KB
EEPROM	1KB
Clock speed	16MHz

In the programming, it is possible to estimate the battery SOC by using direct application. However, this approach is depending on biases as it involves pure integration. Another way to reach this goal is to compute the open-circuit voltage of the battery, by means of linear relationship between the SOC of the battery and its open-circuit voltage. To illustrate the approach, let denotes a_0 as the battery terminal voltage when the 0% SOC, a_1 be the coefficient of the SOC function $s(t)$, and V_{oc} be the terminal voltage when $S(t)=100\%$. Then, $s(t)$ can be computed as,

$$S(t) = \frac{V_{oc}S(t) - a_0}{a_1} \quad (1)$$

Figure 6 shows the graphical-user-interface (GUI) linking the rel time data from the system to the user. The GUI is developed using Blynk that suits to universal gadgets or devices (normally a smartphone). This structure shows how the Blynk send data from the microcontroller to the smartphone. The application provides remote control of the system where the activation of cooling can be ordered remotely from distance. The development phase involves three parts of Blynk namely a Blynk application, Blynk server and Blynk libraries. Blynk application allows user to create amazing interface using widgets. Blynk server is used to communicate between smartphone and hardware. Whereas Blynk library enables communication with the server. The Wi-Fi shield ESP8266-01 module is used as a medium of transmission data between Arduino and Blynk server. Simple computer program is written to enable the communication protocol between the system and device as well as to activate the sensory elements in the system. The program flow chart with the embedded working process of each step is depicted in Figure 7.

2.2. Experiment at ambient temperature

The complete prototype for the solar panel with active cooling system is presented in Figure 8 (a). Experiment of ambient temperature is conducted to analyse the performance and efficiency of the solar panel without the cooling system and with cooling system. The experiment is organized in 7 days period from 9 am to 4 pm daily. The experimental data is gathered via IoT facility. During the experiment, active cooling system operate by applying 45° Celsius water to the top surface of the solar panel. The activation of the cooling system is accomplished by the microcontroller via a set of relay circuit. The solar panel tilt angle has been set to 20° facing south to get the maximum light intensity from the sun. The Table 2 shows the specification of solar (PV) panel for the experiment. Figure 8 (b) shows the GUI displaying data gathered from the experiment.

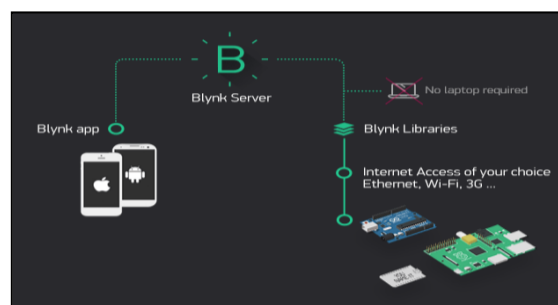

Figure 6. Structure of blynk system

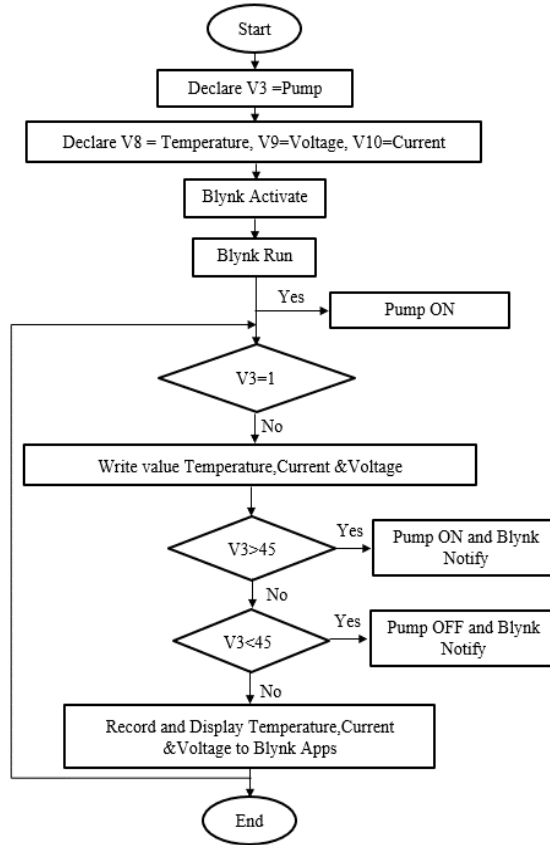

Figure 7. Program flow chart



(a)



(b)

Figure 8. These figures are; (a) System prototype; (b) GUI for monitoring purpose

Table 2. Specification of solar panel

SUNWAY SOLAR Polycrystalline Solar Module	
Model: SW20P-36 (SUNWAY SOLAR)	Maximum power (Pmax): 20W
Maximum power voltage (Vmp) = 18V	Open circuit (Voc) = 21.4V
Maximum power current (Imp) = 1.12A	Short circuit current (Isc) = 1.19A
Dimension = 496 mm x 350 mm x 25 mm	Maximum system voltage = 600V

3. RESULTS AND DISCUSSION

The operation of cooling system is established on the cut-off temperature of 45°C. When the temperature is greater than 45° Celsius, the DC pump is turned ON to activate cooling process. The cooling system remains shut down when the temperature is recorded below 45°C.

3.1. Analysis of I-V towards cooling and non-cooling process

The result obtained from the experiment confirms that the cooling system has helped to increase the average output voltage (V) and current (I) drawn from the solar panel. The numerical results are tabulated in Table 3. It is shown that the cooling system has increased the average voltage from 16.00125 volts to 16.7875 volts. The average current increased from 0.8825 ampere to 1.0125 ampere. Figure 9 portrays the I-V pattern and history during the experiment. The I-V peaks during 12.00-13.00 hours when the PV receives high intense of light. In line with I-V increment due to cooling process, the average output power is also increased from 14.97125 Watt to 18.0575 Watt as depicted in Figure 9 (c). The output voltage, current and power are inversely proportional to the PV surface temperature because of the cooling effect. The temperature pattern can be observed in Figure 9 (d).

Table 3. I-V data-with cooling system and without cooling system

Time (24-Hours)	With Active Cooling System			Without Cooling System		
	Voltage (V)	Current (A)	Power (W)	Voltage (V)	Current (A)	Power (W)
900	13.6	0.43	5.84	13.53	0.41	5.56
1000	13.8	0.48	6.7	13.73	0.45	6.22
1100	17.6	1.10	19.92	16.65	0.97	16.67
1200	18.7	1.36	25.44	17.15	1.17	20.21
1300	19.3	1.46	27.42	17.98	1.26	22.7
1400	17.8	1.22	22.51	17.00	1.07	18.89
1500	16.9	1.05	18.99	16.29	0.90	15.68
1600	16.6	1.00	17.64	15.68	0.83	13.84
Average	16.7875	1.0125	18.0575	16.00125	0.8825	14.97125

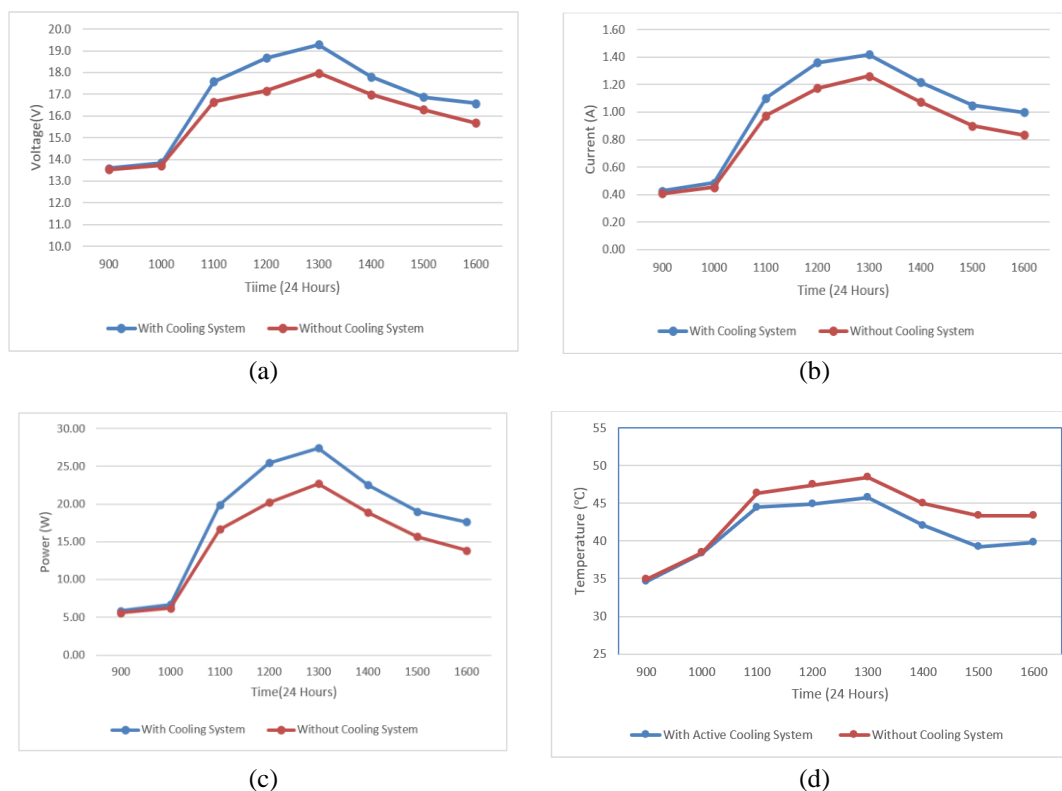

Figure 9. These figures are; (a) voltage, (b) current, (c) power, (d) temperature-with active cooling and without cooling system

3.2. Analysis on the efficiency

When the solar irradiance and ambient temperature changed simultaneously at the same time, the efficiency of the PV will be deteriorated. The deterioration normally due to the blocked sunlight (by the cloud), as well as due to the uncertain weather conditions. Efficiency of PV can be determined by the amount of power input, P_{in} upon the power output, P_{out} . The power input is computed by multiplying the irradiance

(in Wm^{-2}) with the area of the panel in meter square. While the power output is the open circuit voltage, V_{oc} times the short circuit current, I_{sc} . As shown in (2) expresses the formula to obtain the efficiency, η .

$$\eta = \frac{P_{in}}{P_{out}} \quad (2)$$

Based on PV specification, the ideal power input and power output of the PV can be calculated as in (3) and (4).

$$\begin{aligned} P_{in} &= \text{PV Area} \times \text{Irradiance} (Wm^{-2}) \\ &= (0.495m \times 0.350m) \times 1000Wm^{-2} \\ &= 173.25 W \end{aligned} \quad (3)$$

$$\begin{aligned} P_{out} &= 18V \times 1.12A \\ &= 20.16W \end{aligned} \quad (4)$$

To this end, the efficiency of the PV can be computed as around $\eta = 11.63\%$. The ideal value is highly based on the average solar radiation in Malaysia ($1000Wm^{-2}$). From the experiment, the efficiency is tabulated in Table 4. The plot of efficiency towards times is depicted in Figure 10. It can be observed from the plot that the efficiency of the PV has improved around 17.08% because of the cooling process.

Table 4. Efficiency of PV-with cooling system and without cooling system

Time (24-Hours)	Effeciency Of Solar Panel (%)	
	With Active Cooling System	Without Cooling System
900	3.37%	3.21%
1000	3.87%	3.59%
1100	11.50%	9.62%
1200	14.69%	11.66%
1300	15.83%	13.10%
1400	12.99%	10.90%
1500	10.96%	9.05%
1600	10.17%	7.99%
Average	10.42%	8.64%

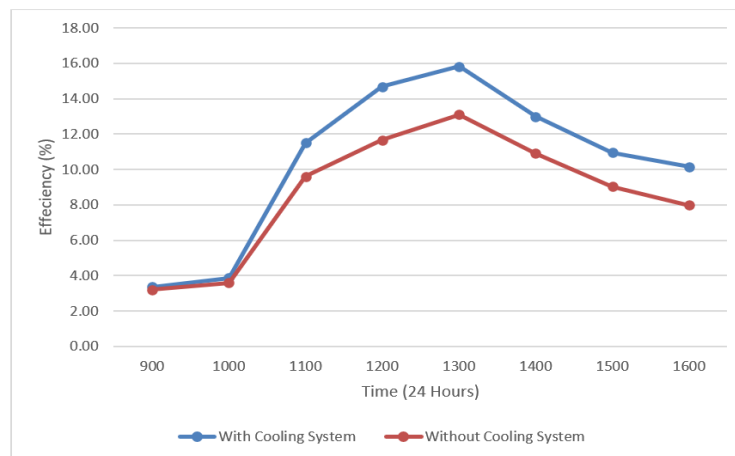

Figure 10. Efficiency-with active cooling and without cooling system

3.3. Observation on SOC

The SOC of the battery is observed via IoT with GUI. The data describes the remaining capacity of 12V 7.2 AH battery in percentage. Table 5 records the energy stored by the battery. The data is taken at 12.00 noon every day in 7 days period.

Table 5. Energy of battery in 7 days period taken at 1200 noon

Days	Voltage (V)	Current (A)	Energy (W/h)
1	13.47	1.26	16.97
2	13.5	1.34	18.09
3	13.5	1.3	17.55
4	13.36	1.21	16.17
5	13.5	1.32	17.82
6	13.3	1.2	15.96
7	13.5	1.27	17.15

The SOC can be computed by dividing the instantaneous charged voltage by the fully charged voltage of 13.5 V lead acid battery and multiplying by 100%. The calculation has been made and were recorded in Table 6. Figure 11 (a) illustrates the SOC pattern in 7 days. Whereas Figure 11 (b) illustrates the SOC towards instantaneous charged voltage.

Table 6. The battery charged in voltage by 7 days.

Days	Voltage (V)	Percentage of SOC of the battery (%)
1	13.47	99.78
2	13.5	100
3	13.5	100
4	13.36	98.96
5	13.5	100
6	13.3	98.52
7	13.5	100

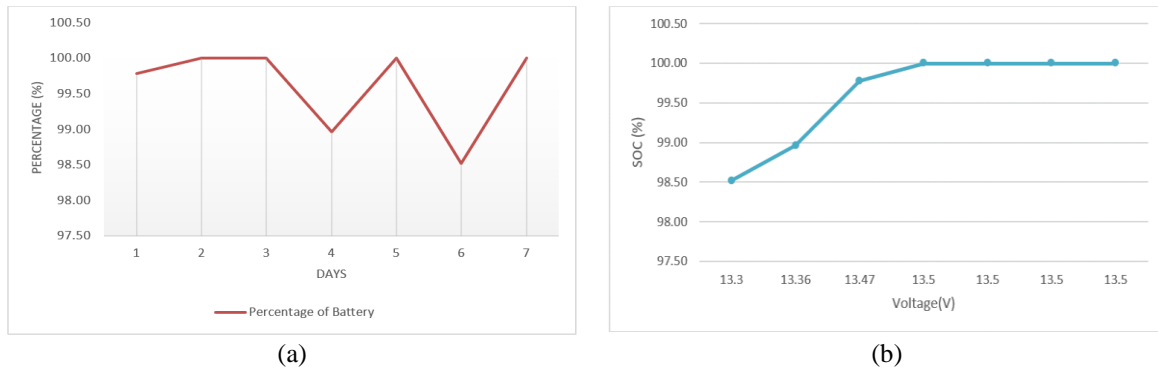

Figure 11. There figures are; (a) SOC vs days; (b) SOC vs voltage

4. CONCLUSION

In this manuscript, two main factors that deteriorate the PV performance were identified. The two factors are sun irradiation and surrounding temperature. Through some experiments and development, findings in this manuscript concluded that the cooling process improved the power output from the PV, enhanced the efficient and expanded the battery SOC. When the temperature is maintained by the cooling apparatus, the output power can be obtained as optimum as it can. The active cooling PV system with IoT developed in this manuscript showed its effectiveness in terms of data collection, data monitoring, automated cooling process, and guaranteed operator-friendly interface. To validate the claims, the observations and experiments are supported with data by thorough analysis.

ACKNOWLEDGEMENTS

Research and development reported in this manuscript were developed by undergraduate student taking the final year projects that are the requirement for the award of the Bachelor's Degree in the Electrical Engineering with honours in the Faculty of Electrical Engineering, Universiti Teknikal Malaysia Melaka. Special acknowledgement is addressed to the Ministry of Higher Education Malaysia, Center for Robotics and Industrial Automation, and all personnel especially Mr. Mohamad Badrul Hisyam Mahalli who help to realize the project.

REFERENCES

- [1] A. Qaziac, H. Fayaz, A. Wadi, R. G. Raj, N. A. Rahim, and W. A. Khan., "The artificial neural network for solar radiation prediction and designing solar systems: a systematic literature review," *Journal of Cleaner Production*, vol. 104, pp. 1-12, 2015, DOI: 10.1016/j.jclepro.2015.04.041.
- [2] M. Riordan and L. Hoddeson, "The origin of the PN junction," *IEEE Spectrum*, vol. 34, no. 6, pp. 46-51, 1997.
- [3] R. S. Ohl, "Light-Sensitive Electric Device," *Washington, DC: U.S. Patent and Trademark Office*, 1946.
- [4] J. H. Scaff and R. S. Ohl, "Development of silicon crystal rectifiers for microwave radar receivers," *Bell System Technical Journal*, vol. 26, pp. 1-30, 1947, doi: 10.1002/j.1538-7305.1947.tb01310.x.
- [5] Z. Hameiri, "Photovoltaic literature survey", *Prog Photovolt Res Appl.*, vol. 28, pp. 167-173, 2020, doi: 10.1002/pip.3266.
- [6] M. N. Kamarudin, N. Shaharudin, N. H. Abd Rahman, M. H. Hairi, S. Md. Rozali, and T. Sutikno, "Review on load frequency control for power system stability," *TELKOMNIKA Telecommunication, Computing, Electronics and Control a*, vol. 19, no. 2, pp. 638-644, 2021, doi: 10.12928/TELKOMNIKA.v19i2.16118.
- [7] M. Couto, J. A. Peças Lopes, and C. L. Moreira, "Control strategies for multi-microgrids islanding operation through smart transformers," *Electric Power System Research*, vol. 174, 2019, doi: 10.1016/j.epsr.2019.105866.
- [8] Z. Q. Bo, X. N. Lin, Q. P. Wang, Y. H. Yi, and F. Q. Zhou, "Developments of power system protection and control," *Protection and Control of Modern Power Systems*, vol. 1, 2016.
- [9] M. Xing, Y. Zhang, Q. Shen, and R. Wanga, "Temperature dependent photovoltaic performance of TiO₂/PbS heterojunction quantum dot solar cells," *Solar Energy*, vol. 195, pp. 1-5, 2020, doi: 10.1016/j.solener.2019.11.010.
- [10] M. S. Jamri and M. N. Kamarudin, "Power stabilization of a stand-alone solar system using perturb and observe MPPT algorithm," *Global Conference on Power Control and Optimization*, 2010.
- [11] S. M. Rompicherla, "Solar energy: The future," *International Journal of Engineering Trends and Technology*, vol. 4, no. 6, pp. 2513-2517, 2013.
- [12] N. A. Windarko, M. N. Habibi, B. Sumantri, E. Prasetyono, and M. Efendi, "A new MPPT algorithm for photovoltaic power generation under uniform and partial shading conditions," *Energies*, vol. 14, no. 483, pp. 1-22, 2021, doi: 10.3390/en14020483.
- [13] M M Rahman, M Mashud, C M Chu, M S bin Misaran, M Sarker and S Kumaresen, "A passive cooling system of residential and commercial buildings in summer or hot season", *3rd International Conference of Mechanical Engineering Research*, 2015, doi: 10.1088/1757-899X/100/1/012031.
- [14] X. Yao, B. J. Dewancker, Y. Guo, S. Han and J. Xu, "Study on passive ventilation and cooling strategies for cold lanes and courtyard houses-a case study of rural traditional village in Shaanxi, China," *Sustainability*, vol. 12, pp. 2-36, 2020, doi: 10.3390/su12208687.
- [15] G. Kumaraguruparan, M. Kameswari, R. Saravanan, M. Vivar, and K. Srithar, "Photovoltaic module with uniform water flow on top surface," *International Journal of Photoenergy*, vol. 2020, pp. 1-9, 2020, doi: 10.1155/2020/8473253.
- [16] D. D. Prija Tjahjana, S. Hadi, R. Adhi Rachmanto, G. Setyohandoko, and B. Sutanto, "Numerical and experimental investigation of air cooling for photovoltaic panels using aluminium heat sinks," *International Journal of Photoenergy*, vol. 2020, pp. 1-10, 2020, doi: 10.1155/2020/1574274.
- [17] K. A. Moharrama, M. S. Abd-Elhady, H. A. Kandil, and H. El-Sherifa, "Enhancing the performance of photovoltaic panels by water cooling," *Ain Shams Engineering Journal*, vol. 4, pp. 869-877, 2013, doi: 10.1016/j.asej.2013.03.005.
- [18] M. A. Ghazali and A. M. Abdul Rahman, "The Performance of three different solar panels for solar electricity applying solar tracking device under the Malaysian climate condition," *Energy and Environment Research*, vol. 2 no. 1, pp. 235-243, 2012.
- [19] M. A. Khan, B. Ko, E. A. Nyari, S. E. Park, and Hee-Je Kim, "Performance evaluation of photovoltaic solar system with different cooling methods and a bi-reflector PV system (BRPVS): An experimental study and comparative analysis," *Energies*, vol. 10, no. 6, 2017, doi: 10.3390/en10060826.
- [20] S. Dubey, J. N. Sarvaiya, and B. Seshadri, "Temperature dependent photovoltaic (PV) efficiency and its effect on PV production in the world: A review," *Energy Procedia*, vol. 33, pp. 311-321, 2013, doi: 10.1016/j.egypro.2013.05.072.
- [21] W. S. Alaloul, M. S. Liew, N. A. Wan Abdullah Zawawi and B. S. Mohammed, "Industry revolution IR 4.0: future opportunities and challenges in construction industry," *MATEC Web of Conferences*, 2018, pp. 1-7, doi: 10.1051/mateconf/201820302010.
- [22] V. Sima, I. G. Gheorghe, J. Subić, and D. Nancu, "Influences of the Industry 4.0 Revolution on the human capital development and consumer behavior: A systematic review," *Sustainability*, vol. 12, no. 4, pp. 1-28, 2020, doi: 10.3390/su12104035.
- [23] S. I. Tay, T. C. Lee, N. Z. A. Hamid, A. N. A. Ahmad, "An overview of Industry 4.0: Definition, components, and government initiatives," *Journal of Advanced Research in Dynamical and Control Systems*, vol. 10, no. 14, pp. 1379-1387, 2018.
- [24] K. Umachandran *et al.*, "Industry 4.0: The new industrial revolution," *Industry 4.0 Book chapter, Chapter 6*, pp. 138-156, doi: 10.4018/978-1-5225-6207-8.ch006.
- [25] M. N. Kamarudin *et al.*, "Realization of real-time hardware-in-the-loop for a liquid level with open-loop Ziegler Nichols technique," *International Journal of Electrical Engineering and Applied Sciences*, vol. 1, no. 2, pp. 47-51, 2018.

BIOGRAPHIES OF AUTHORS

Muhammad Nizam Kamarudin was born in Selangor, Malaysia. He received the B.Eng (Hons.) Electrical from the Universiti Teknologi MARA, Malaysian in 2002, and M.Sc in Automation and Control from the University of Newcastle Upon Tyne, United Kingdom in 2007. He received the Doctor of Philosophy in Electrical Engineering from the Universiti Teknologi Malaysia in 2015. He is currently with the Universiti Teknikal Malaysia Melaka (UTeM). He is the member of the Board of Engineers, Malaysia and Institute of Engineers, Malaysia. His research interests include nonlinear controls and robust control systems. Before joining UTeM, he worked as a Technical Engineer at the magnetron department of Samsung Electronics Malaysia and Suwon, South Korea.



Sahazati binti Md Rozali was born in Melaka on 19th February 1981. She received her degree in Bachelor of Electrical & Electronic Engineering (Electronic) in 2004 from Universiti Sains Malaysia. Then she pursued her Master in Electrical Engineering (Control, Automation & Robotics) in Universiti Teknologi Malaysia on 2006 and Doctor of Philosophy in Electrical Engineering from the same university in 2014. She is a member of Board of Engineers Malaysia (BEM) and Malaysian Board of Technologist (MBOT). Her specialization is in control system, modelling and system identification.



Mohd Saifuzam Jamri was born in October 1984. He received his bachelor degree in Electrical Engineering (Power Electronics & Drives) from Universiti Teknikal Malaysia Melaka, Malaysia in 2007 and received the Master Degree in Electrical Power Engineering from Universiti Teknologi Malaysia in 2009. He is currently worked with the Universiti Teknikal Malaysia Melaka (UTeM) as a lecturer and belongs to Centre for Robotics and Industrial Automation (CeRIA) group. His interest is in power system study and micro-grid including load frequency control (LFC) and renewable energy integration. He is currently persuing the PhD in University Tekninal Malaysia Melaka under Faculty of Electrical Engineering.