

Laboratory prediction energy control system based on artificial intelligence network

Desmira^{1,2}, Norazhar Abu Bakar², Mohd Ruzaini Hashim², Romi Wiryadinata³, Mustofa Abi Hamid^{1,4}

¹Department of Electrical Engineering Vocational Education, Faculty of Teacher Training and Education, Universitas Sultan Ageng Tirtayasa, Serang, Indonesia

²Department of Electrical Engineering, Faculty of Electrical Engineering, Universiti Teknikal Malaysia Melaka, Malaysia

³Department of Electrical Engineering, Faculty of Engineering, Universitas Sultan Ageng Tirtayasa, Serang, Indonesia

⁴Mahiad Research Center, Serang, Indonesia

Article Info

Article history:

Received Nov 26, 2021

Revised Mar 13, 2022

Accepted Apr 1, 2022

Keywords:

ANFIS

Artificial intelligence

Fuzzy logic

Prediction energy control

ABSTRACT

The use of electrical energy increases globally every year. The laboratory prediction energy control system (LPECS) predicted energy demand. This research was conducted in the Electrical Engineering Vocational Education laboratory by comparing the artificial neural fuzzy system (ANFIS) with the fuzzy logic. The comparison of methods aimed to determine their reliability in the energy demand prediction systems. The results showed that the minimum value of the target data using the conventional method (actual data) was 44.42%. Meanwhile, the prediction data using the ANFIS method was 44.33%, and the prediction data using the fuzzy method was 59.31%. The maximum value of the conventional ways (actual data) of ANFIS and fuzzy was similar by 77.59%. The RMSE ANFIS value was 0.1355%, the mean absolute percentage error (MAPE) was 0.2791%, and the fuzzy logic was 0.1986%. Thus, the ANFIS is applicable to determine the minimum and maximum values. Meanwhile, fuzzy can only show the maximum value but cannot reach the minimum value properly.

This is an open access article under the [CC BY-SA](https://creativecommons.org/licenses/by-sa/4.0/) license.



Corresponding Author:

Norazhar Abu Bakar

Department of Electrical Engineering, Faculty of Electrical Engineering

Universiti Teknikal Malaysia Melaka

Hang Tuah Jaya, Durian Tunggal, Melaka 76100, Malaysia

Email: norazhar@utem.edu.my

1. INTRODUCTION

The need for energy increases every day. The energy use in the room has been saved through various efforts. Artificial intelligence (AI) will easily control the energy needed in a room. Moreover, the use of AI positively contributes to evaluate the use of energy in a building [1], [2]. Energy requirements in a room have been widely discussed, including the use of the adaptive neuro-fuzzy inference system (ANFIS) algorithm [3], [4], fuzzy logic [5]-[9], artificial neural network (ANN) [10]-[18], and GA [19], [20]. Several studies have discussed the energy consumption of a building, including comparing ANN algorithms, clustering, statical and machine learning, and support vector machine (SVM). The SVM algorithm shows the best results in predicting energy consumption in a building, but it has not explained how much error accuracy was contained in each algorithm used [14]. A study researched energy consumption between electricity and heating used in a school in Kuopio, eastern Finland [20].

This study presented a computational model to estimate energy consumption in the Electrical Engineering Vocational Education (EEVE) laboratory using AI. The FCM is a clustering technique for the ANFIS model, in which similar time series data were used due to its accuracy and lower computational time

[21]. The performance of the inference system is adapted to the ANFIS, and it is hybrid with the particle swarm optimization (PSO) performance to predict energy consumption from climate factors for multi-campus institutions in South Africa [22]. Changes in energy consumption of forecasting systems used fuzzy logic to reduce uncertainty, inconvenience, and inefficiency [5] of gross annual electricity demand for short-term Turkey by applying the fuzzy logic method [6]. Four ANFIS models were developed, trained, and validated with a trial performance data set that were collected and applied to predict the operating temperature of the system [23]. This study designed and adapted an ANFIS to estimate the energy consumption of the building by considering the main building envelope parameters: the thickness of the material and the value of K insulation [24]. The results showed that the ANN and ANFIS predicted the energy consumption of the cooling load of three buildings with reasonable accuracy. The correlation coefficient between measured and predicted consumption for the training data was significant or above 0.98. The test data also showed the same result for 0.96 [25]. This paper presented and evaluated control strategies to adjust and preserve air quality, thermal comfort, and visual comfort for building occupants. At the same time, energy consumption reduction is achieved [26] to manage energy in residential buildings effectively. An efficient energy control system is required to reduce total energy consumption without compromising users' preferred environment in the building [27]. Gradient-based optimization can be used to minimize the energy consumption of distributed environmental control systems without increasing occupant thermal dissatisfaction [28].

The high-resolution household electricity model used the Fuzzy logic inference system. Using the input pattern of active occupancy and typical household habits, the fuzzy model provides the possibility to start each piece of equipment within the next minute as the output [29] of the designed controller; thus, the significant lighting energy can be saved. Offices that have installed smart LED lighting systems can automatically adjust lighting output based on users' movement and allow them to select their lighting preferences [30]. The fuzzy logic controller can be applied to EAHX to reduce more electrical energy consumption. A simulation is carried out, and the thermodynamic model of EAHX is obtained and used together with fuzzy logic controller simulation. Then, it is compared with the on-off controller simulation [31] of the fuzzy inference system (FIS) and ANN control schemes to simultaneously control the amount of air supply and temperature. The study concludes that mass and temperature control simultaneously maintain the desired room temperature in a very efficient manner [32].

Neural networks and fuzzy systems have some similarities. For example, when a mathematical model of the given problem is unavailable, neural networks and fuzzy systems can be used to solve a problem [33]. The method that combines the two techniques is commonly called a hybrid system; one of which is the ANFIS [34]. The input-output data set of the HVAC system is first stored, and the data set for predicting fan motor speed is based on the ANFIS. In the simulation of this research, the root-mean-square (RMS) and the coefficient of multiple determination (R2), as two performance measures, were obtained to compare the predicted and actual values of the model validation. The results of the statistical analysis obtained an RMS value of 3.3475 and an R2 value for the evaporator of 0.9954. The RMS value was 15.6750 and the R2 was 0.9402 for zone-1. Meanwhile, the RMS was 17.7019 and R2 was 0.9410 for zone-2 for the ANFIS model [35]. The predicted quality of experience (QoE) in a student-centered mixed learning environment was equipped with technologically enriched classrooms. This model used ANFIS with seven and four input variables, it then compared its performance using RMSE, MAPE, and R2 measurements. The results showed that the perceived QoE could be reliably predicted by personality traits and students' learning styles as subjective factors and the network filters as objective factors [36].

A laboratory prediction energy control system (LPECS) used the ANFIS method and fuzzy logic. The laboratory prediction energy control system (LPECS) was compared with conventional measurements (actual data) and AI. The algorithm used in this study compared the real (traditional) data measurement with the ANFIS and fuzzy. The algorithm predicted humidity in a laboratory. The study discussing the implementation of fuzzy logic in a manufacturer to predict energy consumption showed that the percentage of the factory energy consumption changed after the three input parameters had been analyzed. These findings provide a solid basis on which decision-makers and systems analysts can apply to create appropriate strategies to ensure the efficiency and stability of the manufacturing system [5]. The proposed technique was evaluated using FIS Mamdani and FIS Sugeno. The proposed methods provide a flexible and energy-efficient decision-making system that maintains users' thermal comfort with the help of intelligent sensors [37]. This stimulus model was constructed into fuzzy Mamdani type based on modeling rules (RBMTF), using input parameters (Uw, Te) and output parameters d2, and described by the if-then rule of the RBMTF data test of about 97.4%. Overall, the RBMTF can be used as a reliable modeling method for the thermal performance of laminated precast concrete panels used in residential building studies [38]. Fuzzy with Mamdani fuzzy inference method was mainly applied only at the simulation level in this study and compared the MATLAB simulation with microcontroller programming. In the programming, the microcontroller used a methodology to produce the same simulation results [39]-[44].

2. PROPOSED METHOD

2.1. Fuzzy inference system

ANFIS, applied to LPECS, is an artificial neural network that involves the takagi–sugeno–kang (TSK) model of the fuzzy inference system. The ANFIS used in this research consisted of one input layer, three hidden layers, and one output layer. The neuron represented by a square shape was a parameter of the TSK fuzzy membership function. LPECS of the FIS was a computational framework based on the ANFIS theory and consisted of five parts, as presented in Figure 1 [24].

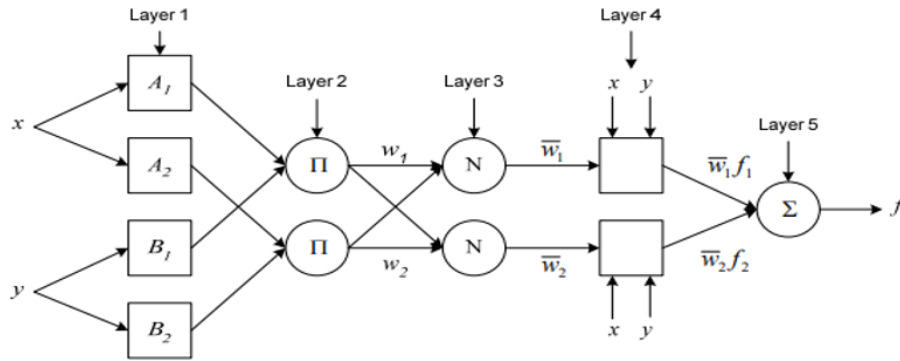

Figure 1. ANFIS architecture

Layer 1 (fuzzification): each neuron was adaptive to the parameters of an activation. The output of each neuron was the degree of membership given by the membership function. The input membership function used a trapezoidal membership type (trapmf).

$$Y_i = \mu_i(x_i) \quad (1)$$

Layer 2 (rules): this layer was a fixed neuron (given the symbol Π) which was the product of all inputs, as in (2).

$$W_i = \mu_{A_i}(x_i) \mu_{B_i}(x_2) \quad (2)$$

The AND operator was usually used. The result of this calculation is called the firing strength of a rule. Each neuron represents the i -rule.

Layer 3 (normalization): each neuron in this layer was a fixed neuron (given the symbol N) which was the result of calculating the ratio of the i -firing strength (w_i) to the sum of the overall firing strength in the second layer, as in (3).

$$\bar{w}_i = \frac{w_i}{\sum_{i=1}^n w_i} \quad (3)$$

Layer 4 (defuzzification): this layer was in the form of neurons which were adaptive neurons to an output, as in (4).

$$\bar{w}_i \cdot f_i = \bar{w}_i (p_i Z_{it} + q_i Z_{2t} r_1) \quad (4)$$

Layer 5 (network output): this layer was a single neuron (symbolized) resulted from totaling all outputs of the fourth layer, as in (5).

$$Y = \sum_{i=1}^n w_i f_i \quad (5)$$

Research data obtained for approximately three months were taken into input and output data. The input data were in the form of power (X_1) and temperature (X_2). Meanwhile, the output data were in the form of humidity (X_t).

2.2. Predicting performance of the ANFIS test and fuzzy logic

There were several ways to test and measure the performance of LPECS prediction comparisons between ANFIS and fuzzy logic. Among them were root mean square error (RMSE) and mean absolute

percentage error (MAPE). RSME was used to find the accuracy of forecasting results with target data, namely humidity data taken conventionally in the EEVE laboratory. The smaller the humidity forecast value with target or goal data in the form of humidity. The result of forecasting results was carried out, and the RSME value starts from 0 to infinity, with 0 being the best value. RMSE can be calculated by (6).

$$RMSE = \sqrt{\frac{\sum_1^n (y_i - y_t)^2}{n}} \quad (6)$$

The next LPECS performance measurement used the MAPE to calculate the difference between conventional (actual) data and forecasting data by using the ANFIS and fuzzy algorithms. The difference was calculated in the form of a percentage of the actual (conventional) data. The subsequent LPECS performance measurement used MAPE to calculate the difference between the original and forecasted data. The difference was inserted according to the MAPE formula and then calculated as a percentage of the original data.

$$MAPE = \frac{\sum \left| \frac{(y_i - y_t)}{y_i} \right|}{n} \times 100 \quad (7)$$

3. METHOD

Figure 2 describes the research flow starting with data collection. Figure 2 denotes that the parameters used were in the forms of power, temperature, and humidity data output target. After the data had been collected, they went to the fuzzification step that grouped the information into input and output data according to the ANFIS steps in (1). Furthermore, the data were further divided into training, testing, and demo data. The following process was creating a rule according to (2). The data were then normalized in the range [0-1]. Then, the information was included in (3). In stage 1, the data used were training data and testing data. The following process was forming a generated FIS. The defuzzification layer was in the form of adaptive neurons to output with (4). In this process, the value of the membership function was determined, the type of membership function was used, and the desired results were gained. The next step was conducting the FIS training stage to determine the epoch value and the employed methods (hybrid and backpropagation). From (5), the steps for ANFIS were added to all input variables from the process of (4). The result was the average RMSE value according to (6). After being trained, the result was processed in the FIS testing stage. Similar to the FIS training in the data testing process, the average RMSE value was obtained. If the RMSE value had been high enough, it would have returned to the FIS generate process. In contrast, if the RMSE value had been good enough, it could have proceeded to the next stages: predicting and comparing actual (conventional) data with fuzzy. The predictive data using the ANFIS algorithm were regrouped. Finally, the comparison values of actual (conventional) data with predictive data were obtained using the ANFIS algorithm.

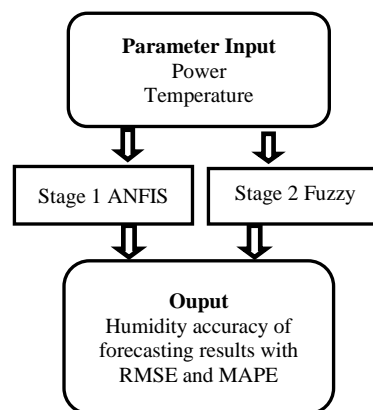

Figure 2. LPECS research

In (5) described that the step for ANFIS was adding up all the input variables from the equation process (4). The result was the average RMSE value according to in (6). After being trained, the result went to the FIS testing stage. Similar to the FIS training in the data testing process, the average RMSE value was

obtained. If the RMSE value had been high enough, it would have returned to the FIS generate process. In contrast, if the RMSE value had been good enough, it would have proceeded to the next stages: predicting and comparing actual (conventional) data with fuzzy. The predictive data using the ANFIS algorithm were regrouped. Finally, the comparison values of actual (conventional) data with predictive data were obtained using the ANFIS algorithm.

4. RESULTS AND DISCUSSION

The results of the ANFIS algorithm can be used as a measurement prediction for actual (conventional) data by producing a fairly good average value of root mean square error (RMSE). The RMSE results for each type of membership are shown in Table 1. The best type of membership is the one that produces the lowest RMSE value. Table 1 denotes that the best RMSE value is using the trapezoidal membership type (trapmf). The graph shows the LPECS comparison of the actual data (conventional data against the ANFIS and fuzzy). Figure 3 shows that the ANFIS, a combination of artificial neural networks and fuzzy logic, is the best method to make predictions. This claim was proven by increasing the minimum value of actual data (conventional data) from 44.42% before the test to 44.33% after using the ANFIS method. However, the results were much different, by 59.31%, when it was compared with fuzzy. The maximum value of the actual data (conventional data) was similar to that of ANFIS and fuzzy by 77.59%. ANFIS can be used significantly as a determinant of the minimum and maximum values, while fuzzy can only show the maximum value but cannot reach the minimum value properly.

Table 1. Comparison of RMSE values of each type of membership

No	Types of membership	Hybrid		Backpropagation	
		Training data	Testing data	Training data	Testing data
1.	<i>Trimf</i>	0.1284	0.2881	0.1516	0.2934
2.	<i>Trapmf</i>	0.1355	0.2791	0.1523	0.2834
3.	<i>Gbellmf</i>	0.1118	0.7413	0.1627	0.2799
4.	<i>Gaussmf</i>	0.1106	0.3923	0.1657	0.2838

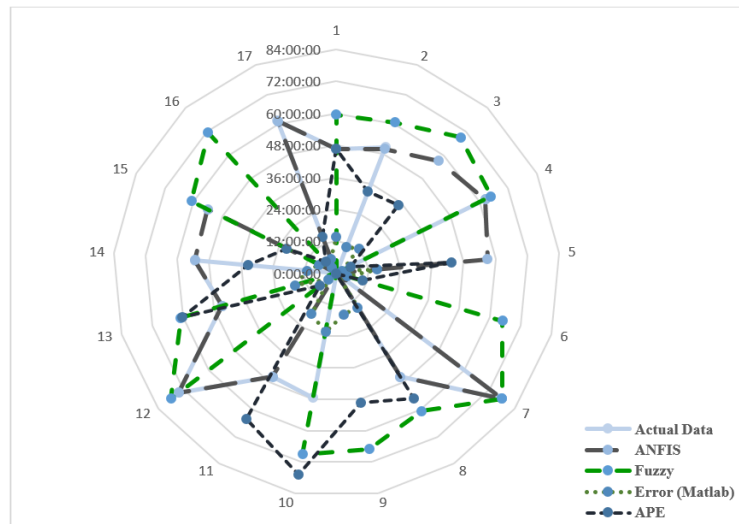

Figure 3. Comparison graph of LPECS actual data (conventional data), ANFIS, and fuzzy against APE

The following is a trapezoidal membership type of training data (trapmf). The output used a linear type of membership function (MF). The results of the training data using the trapezoidal hybrid method (trapmf) obtained an RMSE value of 0.1355, as shown in Figure 4. Figure 5 shows the FIS test used the hybrid method for the type of trapezoidal membership (trapmf). The results obtained an average RMSE value of 0.2791%. The author compared the ANFIS method using the fuzzy method to actual data (conventional data). The results of the actual (conventional) humidity output value, the ANFIS method, and the fuzzy are presented in Table 2.

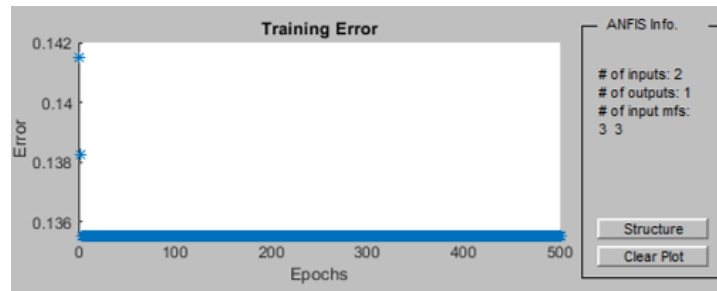

Figure 4. FIS train using a trapezium (Trapmf)

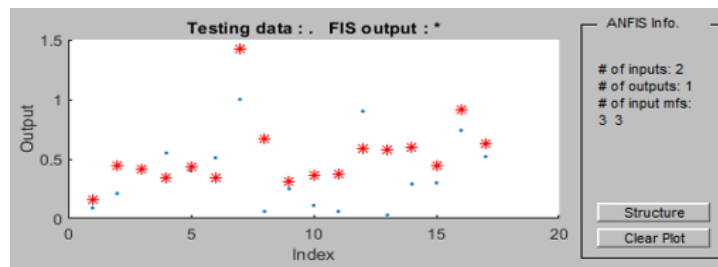

Figure 5. FIS testing using a trapezoid (Trapmf)

Table 2. Comparison of LPECS values of actual (prediction) data, ANFIS, fuzzy error (MATLAB), and APE

No	Actual data	ANFIS	Fuzzy	Errors (MATLAB)	APE
1	46.33	46.44	59.31	12.98	0.2801
2	50.49	50.5	60.45	9.96	0.1972
3	57.66	57.08	69.6	11.94	0.2070
4	62.23	62.23	64.46	2.23	0.0358
5	56.99	57.02	71.86	14.87	0.2609
6	60.79	60.75	64.46	3.67	0.0603
7	77.59	77.59	77.59	0	0
8	45.41	45.32	60.45	15.04	0.3312
9	51.91	50.71	67.3	15.39	0.2964
10	47.23	48.61	69.02	21.79	0.4613
11	45.26	45.38	62.74	17.48	0.3862
12	74.14	74.16	77.59	3.45	0.0465
13	44.42	44.33	60.45	16.03	0.3608
14	53.21	53.24	63.87	10.66	0.2003
15	53.69	53.59	60.45	6.76	0.1259
16	68.84	68.67	71.31	2.47	0.0358
17	61.26	61.13	66.72	5.46	0.0891
MAPE					0.1985

The data processing using fuzzy logic discovered a higher average result, as summarized in Table 2. Each humidity value in the actual (conventional), ANFIS, and fuzzy data was 56.32, 66.33, and 56.28 respectively. The comparison values of actual (conventional), ANFIS, and fuzzy data are presented in Figure 3. All nodes in this layer were non-adaptive as a result of the predictions. The value of the RMSE started from 0 to infinity, in which 0 was the best value. The RSME can be calculated by (6). Table 2 shows the comparison of the actual (conventional data), fuzzy, error (MATLAB), and APE data. The results of fuzzy were much different by 59.31%. To obtain the MAPE value, in (7) with MAPE fuzzy logic was employed, and the result was 0.1985%.

5. CONCLUSION

The research in the laboratory prediction energy control system (LPECS) predicted energy needs. As proven by the increasing minimum value of actual data (conventional data) from 44.42% before the processing to 44.33% after using the ANFIS. The results of fuzzy were much different by 59.31%. The maximum value of the actual data was similar to that of ANFIS and fuzzy by 77.59%. ANFIS could be used significantly as a minimum and maximum value prediction. Meanwhile, the fuzzy could only show the

maximum value but could not reach the minimum value properly. The need for electrical energy consumption in the EEVE laboratory was predicted using the ANFIS algorithm. The results showed the score of fuzzy logic was 0.1355%, the ANFIS RMSE was 0.2791%, and the fuzzy logic MAPE was 0.1985%. These results concluded that the error value between ANFIS and fuzzy logic was almost equal by 0.1. This conclusion predicts that the use of electrical energy in a room can be applied properly by using the ANFIS algorithm and fuzzy logic.

ACKNOWLEDGEMENTS

Author thanks to Endi Permata for giving advice on several parts of this paper and to Siska Riski Abilaila who had played a role in collecting data.





REFERENCES

- [1] Z. Wang and R. S. Srinivasan, "A review of artificial intelligence based building energy prediction with a focus on ensemble prediction models," *2015 Winter Simulation Conference (WSC)*, 2015, pp. 3438-3448, doi: 10.1109/WSC.2015.7408504.
- [2] S. S. K. Kwok, R. K. K. Yuen, and E. W. M. Lee, "An intelligent approach to assessing the effect of building occupancy on building cooling load prediction," *Building and Environment*, vol. 46, no. 8, pp. 1681-1690, Aug. 2011, doi: 10.1016/J.BUILDENV.2011.02.008.
- [3] B. B. Ekici and U. T. Aksoy, "Prediction of building energy needs in early stage of design by using ANFIS," *Expert Systems with Applications*, vol. 38, no. 5, pp. 5352-5358, May 2011, doi: 10.1016/J.ESWA.2010.10.021.
- [4] Q. Xie, J. Q. Ni, J. Bao, and Z. Su, "A thermal environmental model for indoor air temperature prediction and energy consumption in pig building," *Building and Environment*, vol. 161, p. 106238, Aug. 2019, doi: 10.1016/J.BUILDENV.2019.106238.
- [5] H. C. W. Lau, E. N. M. Cheng, C. K. M. Lee, and G. T. S. Ho, "A fuzzy logic approach to forecast energy consumption change in a manufacturing system," *Expert Systems with Applications*, vol. 34, no. 3, pp. 1813-1824, Apr. 2008, doi: 10.1016/J.ESWA.2007.02.015.
- [6] S. Kucukali and K. Baris, "Turkey's short-term gross annual electricity demand forecast by fuzzy logic approach," *Energy Policy*, vol. 38, no. 5, pp. 2438-2445, May 2010, doi: 10.1016/J.ENPOL.2009.12.037.
- [7] S. Bissey, S. Jacques, and J. C. Le Bunetel, "The Fuzzy Logic Method to Efficiently Optimize Electricity Consumption in Individual Housing," *Energies 2017, Vol. 10, Page 1701*, vol. 10, no. 11, p. 1701, Oct. 2017, doi: 10.3390/EN10111701.
- [8] D. Desmira, M. A. Hamid, Irwanto, S. D. Ramdani, and T. Y. Pratama, "An ultrasonic and temperature sensor prototype using fuzzy method for guiding blind people," *Journal of Physics: Conference Series*, vol. 1446, no. 1, p. 012045, Jan. 2020, doi: 10.1088/1742-6596/1446/1/012045.
- [9] D. Desmira, M. A. Hamid, N. A. Bakar, M. Nurtanto, and S. Sunardi, "Smart Traffic Lights Using Microcontroller Based on Fuzzy Logic," *IAES International Journal of Artificial Intelligence*, vol. 11, no. 3, 2022, doi: 10.11591/ijai.v11.i3.pp1-10.
- [10] C. Deb, L. S. Eang, J. Yang, and M. Santamouris, "Forecasting diurnal cooling energy load for institutional buildings using Artificial Neural Networks," *Energy and Buildings*, no. 14, pp. 1-14, Jun. 2015, doi: 10.1016/J.ENBUILD.2015.12.050.
- [11] A. H. Neto and F. A. S. Fiorelli, "Comparison between detailed model simulation and artificial neural network for forecasting building energy consumption," *Energy and Buildings*, vol. 40, no. 12, pp. 2169-2176, Jan. 2008, doi: 10.1016/J.ENBUILD.2008.06.013.
- [12] M. Kim, S. Jung, and J. W. Kang, "Artificial Neural Network-Based Residential Energy Consumption Prediction Models Considering Residential Building Information and User Features in South Korea," *Sustainability 2020*, vol. 12, no. 1, p. 109, Dec. 2019, doi: 10.3390/SU12010109.
- [13] S. R. Mohandes, X. Zhang, and A. Mahdiyar, "A comprehensive review on the application of artificial neural networks in building energy analysis," *Neurocomputing*, vol. 340, pp. 55-75, May 2019, doi: 10.1016/J.NEUCOM.2019.02.040.
- [14] T. Ahmad, H. Chen, Y. Guo, and J. Wang, "A comprehensive overview on the data driven and large scale based approaches for forecasting of building energy demand: A review," *Energy and Buildings*, vol. 165, pp. 301-320, Apr. 2018, doi: 10.1016/J.ENBUILD.2018.01.017.
- [15] K. Li, H. Su, and J. Chu, "Forecasting building energy consumption using neural networks and hybrid neuro-fuzzy system: A comparative study," *Energy and Buildings*, vol. 43, no. 10, pp. 2893-2899, Oct. 2011, doi: 10.1016/J.ENBUILD.2011.07.010.
- [16] J. S. Chou and D. K. Bui, "Modeling heating and cooling loads by artificial intelligence for energy-efficient building design," *Energy and Buildings*, vol. 82, pp. 437-446, Oct. 2014, doi: 10.1016/J.ENBUILD.2014.07.036.
- [17] R. Mena, F. Rodríguez, M. Castilla, and M. R. Arahal, "A prediction model based on neural networks for the energy consumption of a bioclimatic building," *Energy and Buildings*, vol. 82, pp. 142-155, Oct. 2014, doi: 10.1016/J.ENBUILD.2014.06.052.
- [18] A. Azadeh, S. F. Ghaderi, S. Tarverdian and M. Saberi, "Integration of Artificial Neural Networks and Genetic Algorithm to Predict Electrical Energy consumption," *IECON 2006 - 32nd Annual Conference on IEEE Industrial Electronics*, 2006, pp. 2552-2557, doi: 10.1109/IECON.2006.348098.
- [19] H. Ceylan and H. K. Ozturk, "Estimating energy demand of Turkey based on economic indicators using genetic algorithm approach," *Energy Conversion and Management*, vol. 45, no. 15-16, pp. 2525-2537, Sep. 2004, doi: 10.1016/J.ENCONMAN.2003.11.010.
- [20] M. Raatikainen, J. P. Skön, K. Leiviskä, and M. Kolehmainen, "Intelligent analysis of energy consumption in school buildings," *Applied Energy*, vol. 165, pp. 416-429, Mar. 2016, doi: 10.1016/J.APENERGY.2015.12.072.
- [21] P. Adedeji, N. Madushele, and S. Akinlabi, "Adaptive Neuro-fuzzy Inference System (ANFIS) for a multi-campus institution energy consumption forecast in South Africa," in *Proceedings of the International Conference on Industrial Engineering and Operations Management*, Sep. 2018, pp. 950-958.
- [22] P. A. Adedeji, S. Akinlabi, N. Madushele, and O. O. Olatunji, "Hybrid adaptive neuro-fuzzy inference system (ANFIS) for a multi-campus university energy consumption forecast," pp. 1-10, 2020, doi: 10.1080/01430750.2020.1719885.
- [23] L. Yang and E. Entchev, "Performance prediction of a hybrid microgeneration system using Adaptive Neuro-Fuzzy Inference System (ANFIS) technique," *Applied Energy*, vol. 134, pp. 197-203, Dec. 2014, doi: 10.1016/J.APENERGY.2014.08.022.





- [24] S. Naji *et al.*, "Application of adaptive neuro-fuzzy methodology for estimating building energy consumption," *Renewable and Sustainable Energy Reviews*, vol. 53, pp. 1520–1528, Jan. 2016, doi: 10.1016/J.RSER.2015.09.062.
- [25] C. Deb, L. S. Eang, J. Yang, and M. Santamouris, "Forecasting Energy Consumption of Institutional Buildings in Singapore," *Procedia Engineering*, vol. 121, pp. 1734–1740, Jan. 2015, doi: 10.1016/J.PROENG.2015.09.144.
- [26] D. Kolokotsa, D. Tsiavos, G. S. Stavrakakis, K. Kalaitzakis, and E. Antonidakis, "Advanced fuzzy logic controllers design and evaluation for buildings' occupants thermal–visual comfort and indoor air quality satisfaction," *Energy and Buildings*, vol. 33, no. 6, pp. 531–543, Jul. 2001, doi: 10.1016/S0378-7788(00)00098-0.
- [27] M. Fayaz and D. H. Kim, "Energy Consumption Optimization and User Comfort Management in Residential Buildings Using a Bat Algorithm and Fuzzy Logic," *Energies* 2018, vol. 11, no. 1, p. 161, Jan. 2018, doi: 10.3390/EN11010161.
- [28] S. Ari, I. A. Cosden, H. E. Khalifa, J. F. Dannenhoffer, P. Wilcoxon, and C. Isik, "Constrained fuzzy logic approximation for indoor comfort and energy optimization," *Annual Conference of the North American Fuzzy Information Processing Society - NAFIPS*, vol. 2005, pp. 500–504, 2005, doi: 10.1109/NAFIPS.2005.1548586.
- [29] L. Ciabattoni, M. Grisostomi, G. Ippoliti, and S. Longhi, "Fuzzy logic home energy consumption modeling for residential photovoltaic plant sizing in the new Italian scenario," *Energy*, vol. 74, no. 1, pp. 359–367, Sep. 2014, doi: 10.1016/J.ENERGY.2014.06.100.
- [30] J. Liu, W. Zhang, X. Chu, and Y. Liu, "Fuzzy logic controller for energy savings in a smart LED lighting system considering lighting comfort and daylight," *Energy and Buildings*, vol. 127, pp. 95–104, Sep. 2016, doi: 10.1016/J.ENBUILD.2016.05.066.
- [31] S. E. Diaz, J. M. T. Sierra, and J. A. Herrera, "The use of earth–air heat exchanger and fuzzy logic control can reduce energy consumption and environmental concerns even more," *Energy and Buildings*, vol. 65, pp. 458–463, Oct. 2013, doi: 10.1016/J.ENBUILD.2013.06.028.
- [32] J. Ahn, S. Cho, and D. H. Chung, "Analysis of energy and control efficiencies of fuzzy logic and artificial neural network technologies in the heating energy supply system responding to the changes of user demands," *Applied Energy*, vol. 190, pp. 222–231, Mar. 2017, doi: 10.1016/J.APENERGY.2016.12.155.
- [33] J. J. Buckley and H. Yoichi, "Neural nets for fuzzy systems," *Fuzzy Sets and Systems*, vol. 71, no. 3, pp. 265–276, May 1995, doi: 10.1016/0165-0114(94)00282-C.
- [34] J. -S. R. Jang, "ANFIS: adaptive-network-based fuzzy inference system," in *IEEE Transactions on Systems, Man, and Cybernetics*, vol. 23, no. 3, pp. 665–685, May–June 1993, doi: 10.1109/21.256541.
- [35] S. Soyguder and H. Alli, "Predicting of fan speed for energy saving in HVAC system based on adaptive network based fuzzy inference system," *Expert Systems with Applications*, vol. 36, no. 4, pp. 8631–8638, May 2009, doi: 10.1016/J.ESWA.2008.10.033.
- [36] T. Vasileva-Stojanovska, M. Vasileva, T. Malinovski, and V. Trajkovik, "An ANFIS model of quality of experience prediction in education," *Applied Soft Computing*, vol. 34, pp. 129–138, Sep. 2015, doi: 10.1016/J.ASOC.2015.04.047.
- [37] Q. U. Ain, S. Iqbal, S. A. Khan, A. W. Malik, I. Ahmad, and N. Javaid, "IoT Operating System Based Fuzzy Inference System for Home Energy Management System in Smart Buildings," *Sensors* 2018, Vol. 18, Page 2802, vol. 18, no. 9, p. 2802, Aug. 2018, doi: 10.3390/S18092802.
- [38] M. Tosun, K. Dincer, and S. Baskaya, "Rule-based Mamdani-type fuzzy modelling of thermal performance of multi-layer precast concrete panels used in residential buildings in Turkey," *Expert Systems with Applications*, vol. 38, no. 5, pp. 5553–5560, May 2011, doi: 10.1016/J.ESWA.2010.10.081.
- [39] W. N. Sharpe, Mo-Yuen Chow, S. Briggs and L. Windingland, "A methodology using fuzzy logic to optimize feedforward artificial neural network configurations," in *IEEE Transactions on Systems, Man, and Cybernetics*, vol. 24, no. 5, pp. 760–768, May 1994, doi: 10.1109/21.293489.
- [40] A. Ergin, E. Karaesmen, A. Micallef, and A. T. Williams, "A new methodology for evaluating coastal scenery: fuzzy logic systems," *Area*, vol. 36, no. 4, pp. 367–386, Dec. 2004, doi: 10.1111/J.0004-0894.2004.00238.X.
- [41] I. A. Darmawan *et al.*, "Electricity course on vocational training centers: A contribution to unemployment management," in *Journal of Physics: Conference Series*, Feb. 2020, vol. 1456, no. 1, p. 12048, doi: 10.1088/1742-6596/1456/1/012048
- [42] M. A. Hamid, S. A. Rahman, I. A. Darmawan, M. Fatkhurrohman, and M. Nurtanto, "Performance efficiency of virtual laboratory based on Unity 3D and Blender during the Covid-19 pandemic," *Journal of Physics: Conference Series*, vol. 2111, no. 1, p. 012054, Nov. 2021, doi: 10.1088/1742-6596/2111/1/012054.
- [43] M. A. Hamid, D. Aditama, E. Permata, N. Kholifah, M. Nurtanto, and N.W.A. Majid, "Simulating the Covid-19 Epidemic Event and its Prevention Measures using Python Programming," *Indonesian Journal of Electrical Engineering and Computer Science*, vol. 26, no. 1, pp. 278–288, 2022, doi: 10.11591/ijeecs.v26.i1.pp278-288.
- [44] A. Rahmat, A. R. Nugroho, A. Saregar, M. A. Hamid, M. R. N. Prastyo, and A. Mutolib, "Small Hydropower Potential of Rivers in Sukabumi Regency, West Java, Indonesia," *Journal of Physics: Conference Series*, vol. 1155, no. 1, p. 012041, Feb. 2019, doi: 10.1088/1742-6596/1155/1/012041.

BIOGRAPHIES OF AUTHORS





Desmira     She is currently a lecturer with Universitas Sultan Ageng Tirtayasa (Untirta), Indonesia. She is also an Assistant Professor with the Department of Electrical Engineering Vocational Education, Untirta. She has published more than 40 research articles, with more than 80 citations received in the Google Scholar and H-index 3. His research interests in the areas of electrical engineering, sensors, electronics. She can be contacted at email: desmira@untirta.ac.id.







Norazhar Abu Bakar     (Member, IEEE) received his BEng. (Hons.) degree in electronics and electrical engineering from Leeds University, UK, MSc. (Eng.) in control systems from Sheffield University, UK, and PhD degree in electrical and computer engineering from Curtin University, Australia. He started his career as an assembly engineer at Toshiba Electronics, Malaysia, and then moved to TNB as a SCADA/DA Project Engineer. Currently, he is the Deputy Dean (Research & Postgraduate Studies) with the Faculty of Electrical Engineering, UTeM. He is a member of the High Voltage Engineering Research Laboratory in UTeM. His research interests are condition monitoring, asset management, and artificial intelligence. Since 2013, he has published several articles related to transformer condition monitoring and asset management in IEEE Transactions on Dielectrics and Electrical Insulation and IEEE Electrical Insulation Magazine. He can be contacted at email: norazhar@utem.edu.my.







Mohd Ruzaini Hashim     (Member, IEEE) is lecturer in Faculty of Electrical Engineering, Universiti Teknikal Malaysia Melaka (UTeM). He has published more than 20 research articles, with more than 73 citations received in the Google Scholar and H-index 4. His research interests in the areas of educational courses, electrical engineering education, and mechatronics. He can be contacted at email: ruzaini@utem.edu.my.



Romi Wiryadinata     (Member, IEEE) received his B.Eng. degree in electrical engineering from Universitas Islam Indonesia, Yogyakarta, Indonesia. M.Eng. in control systems from Universitas Gadjah Mada, Yogyakarta, Indonesia and Dr. degree in electrical engineering from Universitas Gadjah Mada, Yogyakarta, Indonesia. He started his career as a lecturer at Department of Electrical Engineering, Universitas Sultan Ageng Tirtayasa. Currently, he is the Head of Department of Electrical Engineering, Faculty of Engineering, Universitas Sultan Ageng Tirtayasa. He has published more than 80 research articles, with more than 258 citations received in the Google Scholar and H-index 9. His research interests are sensor and instrumentation, robotics, telecontrol, and disaster and mitigation. He can be contacted at email: wiryadinata@untirta.ac.id.



Mustofa Abi Hamid     (Member, IEEE) has been the secretary of Department of Electrical Engineering Vocational Education, Universitas Sultan Ageng Tirtayasa (Untirta), Indonesia, since 2021. He is currently a lecturer with Untirta. He is also a Assistant Professor with the Department of Electrical Engineering Vocational Education, Faculty of Teacher Training and Education, Untirta. He has published more than 40 research articles, with more than 570 citations received in the Google Scholar and Scopus H-index 2. His research interests include in the areas of electrical engineering, electronics, technical and vocational education, curriculum design, learning strategies, learning media, ICT for learning. He is on the Editor-in-Chief of the Journal of Vocational and Technical Education and Training (Voctech) and VOLT: Jurnal Ilmiah Pendidikan Teknik Elektro and reviewer more than international journal. He can be contacted at email: abi.mustofa@untirta.ac.id.