

Micro-Influence of Vacuum Block Positions on Machinability of Acrylic Using Hybrid Vacuum Clamping System

M. Amirul Adli¹, N. Ab Wahab², M. Harezul Abd Razak², M. Ridzuan Azizzi², Mohd Hadzley Abu Bakar²,
H. Sasahara³

¹Faculty Manufacturing Engineering, Universiti Teknikal Malaysia Melaka, Hang Tuah Jaya, 76100 Durian Tunggal, Melaka, Malaysia

²Faculty of Mechanical and Manufacturing Engineering Technology, Universiti Teknikal Malaysia Melaka, Hang Tuah Jaya, 76100 Durian Tunggal, Melaka, Malaysia

³Department of Mechanical Systems Engineering, Tokyo University of Agriculture and Technology, Japan

ABSTRACT

The double-sided vacuum clamber is used in this project to study the engraving and end mill machining output. This paper proposes a mechanical repair solution for clamping which does not leave any trace on the clamped surface and can accommodate tiny workpiece thicknesses. Mass production must rapidly and efficiently locate the workpiece for specific operations. Using vacuum clamp, which can often clamp small, thin parts, to attach and release the workpiece. The hybrid vacuum system capable to support the capacity of machining with two conditions: continuous air pressure and remained air pressure from the compressor. The design of the dual side vacuum block is fully designed with the software SolidWorks, which is analyzed the mechanical properties by using the Static Analysis Simulation. The findings show that the solid vacuum block Delrin led to improved static analysis results. CNC router machine used in the experiments, with a 3 mm diameter to engrave and end milling process to acrylic workpiece. After the experiment, an evaluation has been made on the extent of precision and surface roughness. The most ideal position of the vacuum clamping is side by side with distance due to the nearer clamping force.

Keywords: Acrylic, depth of cut, hybrid vacuum clamping, surface roughness, vacuum block.

1. INTRODUCTION

Components with low thin wall stiffness are often used in the aviation and automotive, plastic and electronic industries [1]. The thin sections elastically deform during the machining of thin-walled parts under the action of thrust forces. The limited surface cannot place the workpiece to be cut or drilled in a single side clamping [2]. This requires the operator to repeatedly load and adjust the clamping vice to each referring process [3]. Thus, maintaining dimensional accuracy and providing the desired surface finish are quite difficult. Current conventional clamping techniques are not suitable for future applications on thin-walled parts machining. The requirements of components on clamping systems increase when the thickness complexity is not constant [4].

Therefore, it is a common problem in machining thin-walled components. Mechanical clamping is widely used in the milling, turning and fabrication of metal and non-metal workpieces to effectively clamp the workpiece onto the table [5]. An optimum thickness of the workpiece to be clamped on the mechanical clamp is present. The mechanical clamp does not provide small thickness components efficient clamping [6]. Vacuum clamping systems are commonly applied for quick and simple machining of wood, plastics and non-ferrous metal industries. It is compatible with CNC machine tools as it can be connected from all directions with special

handling systems to fix plate and machining. Therefore, it can significantly increase productivity and lower costs. When using vacuum clamping, any damage on the workpiece surface can reduce. In a vacuum, clamping is under strain to generate the pressure when the workpiece is clamped on the clamping plate with different pressures. It can hold or grip many different shapes of workpieces.

Clamping large plate workpiece using vacuum clamp whether table top vacuum clamp or multiple vacuum block. Here in this study focus on clamping large plate using multiple block and study the position of the vacuum block. One of the target is to conclude the possibility clamping without support block. Therefore, the vacuum position depends on the workpiece size. The smaller pieces require a greater vacuum to compensate for reduced surface area or less machining force. As one of the clamping methods, the vacuum clamping can be more stable and offers less vibration while machining and operating in clamping [7,8].

Apart from that, vacuum clamping depends on the vacuum suction force and workpiece surface area. Vacuum clamping has two pressure levels to generate pressure, such as the pneumatic clamping system where the experiment is continuously pressed with air [9]. In contrast, the hydraulic clamping system uses oil. With the pressure produced under the clamping workpiece, the air pressure suction vacuum system is in operation. When the pressure is produced, it is always controlled by gripping the workpiece against the clamping plate. The workpiece will suck through the air suction to support the workpiece that is connected to a lower surface and a non-planar surface [10]. Thus, the vacuum suction force on the workpiece depends on the surface structure, the friction and the region on which the vacuum works. The greater the field, the stronger the remaining forces.

In the design industry, this tool is considered 'common' for the engraving process. The standard conical graving tool requires removing half the material from the end that exponentially weakens the tool's tip [11]. This tool design is still acceptable for engraving softer materials such as plastic or aluminium [12]. It is also important to ensure that the end mill could machine the entire work surface without interruption [13]. Accuracy in dimension and roughness of the surface affects the engraving quality, which is dimensionally precise depending on the accuracy set by the mainframe and CNC holding methods. The surface roughness relies on the geometry, rotational speed, overlap and cut solution parameter of the tools.

A vacuum is a state in a free space [14]. It is generally called a vacuum when the air continuously pressures a space to be less than that of the atmosphere. In vacuum clamping, an under pressure is generated beneath the workpiece being clamped, i.e. a pressure differential is created which presses the workpiece against the clamping plate. Thus, the workpiece will not be sucked but is rather pressed against the vacuum table. The workpiece sliding force depends on its surface structure, the pressure differential and the area on which the vacuum acts. The larger the area, the better the holding force. The vacuum clamping systems used are wood, plastics and non-ferrous metals for quick and simple machining. It can also be performed on CNC machine tools. The benefits of using the vacuum clammer in production include increased productivity, reduced setting time and minimum cost in terms of maintenance and components. An even pressure of approximately 70kPa is used in the experiment testing, consisting of the continuous pressure method and remaining pressure method on an object's surface. Secondly, continuous pressure always provides air pressure to the system. In contrast, the remaining pressure method will turn off the pressure flow from the system to the vacuum clammer, but it can still clamp. The pressure drops every 5 minutes because of the surrounding atmosphere. Using air suction, the air underneath the component is sucked away.

Figure 1 presents a flow process describing each system of the vacuum clamp system function. Every flow in the vacuum can be understood with the use of this flowchart. The vacuum clamping pressure applies suction through the continuous air pressure to the vacuum block. It is generally categorised as a pneumatic system. This vacuum clamp has received input from each method employed to obtain the output by vacuum clamping performances.

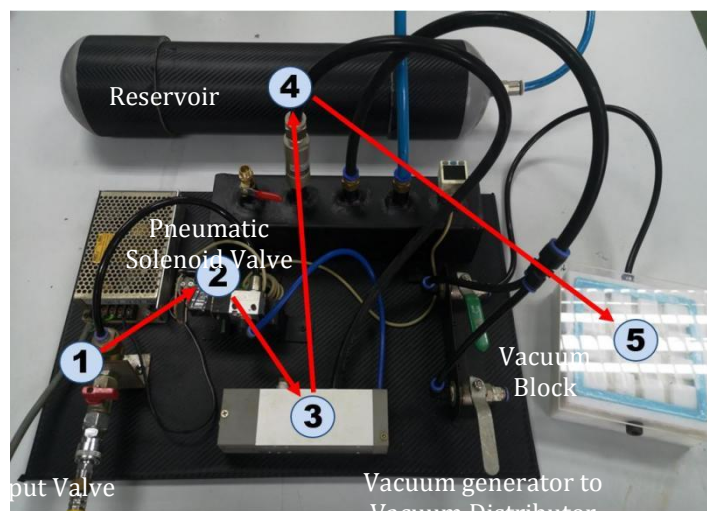

Figure 1. Hybrid vacuum clamping system.

2. METHODOLOGY

2.1 Development of Polyamide and Delrin Dual Side Vacuum Block

In this study, a new range of vacuum clamping devices for machining has been developed to ensure that the vacuum block is firmly in place, enabling precise machining performance. The lightweight characteristic is the most essential feature. In comparison to stainless steel, the highly resilient polyamide vacuum block has lightweight advantages due to the polyamide. This is the only possibility for decreasing mass and improving efficiency. The new vacuum block structure adheres to the relevant standards. Without external mechanical clamping or attachment tabs on the dual side vacuum frame, the vacuum block is firmly clamped to any flat surface foundation. Using the top vacuum, the workpiece is clamped to assist all round machining without contours of intervention. In order to achieve the objectives for this vacuum clamping system, comprehensive procedures have helped establish the required steps or process interventions. The theory of vacuum clamping is typically and mainly used for the preservation of flat surface workpiece or goods. In this project, emphasis is placed on the latest enhancements of the previous vacuum pad as well as the methods for creating a vacuum clamping mechanism, such as the dual vacuum clamber. This mechanism can be utilised as a clamber on the upper and lower sides of the vacuum block. This section provides an outline of the process required for building a vacuum clamping device and evaluates its effectiveness throughout various machining parameters and results.

2.2 Computer Aided Design and Computer Aided Manufacturing of Dual Side Vacuum Block in SolidWorks and Catia Software

The Computer Aided Design (CAD) is the use of computer technology that helps design and document a product's design process. The design can include the stages of development, adjustment, analysis and optimisation. The CAD software types are applied to improve productivity, performance and communication throughout the design process. The CAD was

created by the SolidWorks software. The scale of the rectangular hollow polyamide and hollow Delrin vacuum block is 153 mm x 153 mm x 52 mm, as shown in Figure 2.1. The rubber sealant, as the suction force range, is available from 1 kPa to 70 kPa. After the 3D dual side vacuum clamp block design was completed in the SolidWorks software, the component design was exported from the CAD design to a CAM-compatible format, such as STEP or IGES. Before proceeding with the preparation of CAM, the design of the part was briefly evaluated to verify whether or not the geometry of the part meets the requirements of Catia CAM. If the component does not meet the required specifications, it must be rebuilt in the SolidWorks software. Figure 2 displays the vacuum block of the stage file format.

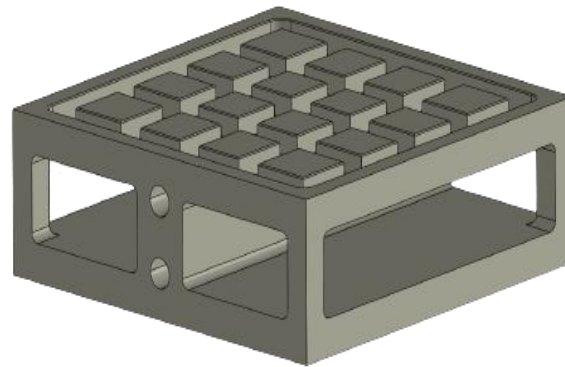

Figure 2. Vacuum block design for polyamide and delrin material.

2.3 Static Analysis for Both Designs of the Dual Side Vacuum Block

The purpose of this analysis is to explore the static data of simple entities with complex structures. Before simulating the model, the first step is to assign the material properties to the model. In this study, the Delrin material (or scientifically known as polyoxymethylene, POM or polyamide, PA) was chosen with several characteristics such as tensile strength, compressive strength, yield strength, mass density, etc. This study presents the workflow of the conducted analysis and examines the results and outcomes. The necessary graphs were generated to determine how to evaluate the quality of the produced mesh by modifying the mesh properties based on end results as well as how to improve the accuracy of the results. Depending on the geometry and dimension of the model, the element's size, mesh tolerance, mesh control and contact specifications were analysed to determine the specific size of the mesh (number of nodes and elements).

Meshing produces 3D solid tetrahedral and 2D triangular shell elements or elements from the 1D beam. After setting the mesh parameters to the element size of 5 mm and 0.5 mesh tolerance in the created mesh dialogue box, the analysis was initiated. The mesh will generally automate and display the meshed results, providing 301576 nodes and 192752 elements in this case. The designed symmetrical geometry machine unit or circular geometry exposed to symmetrical boundary conditions was also examined. Overall, this study evaluates the differences between the various designs of the finite element analysis.

2.4 Selective Laser Sintering and 5-Axis CNC Machining of Dual Side Vacuum Blocks

In this section, the pocket shape produced on a plate made of acrylic or thermoplastic material was 6 mm in thickness. This experiment investigated whether it is possible to conduct pocket machining on an acrylic plate. The experiment tested two types: hollow polyamide vacuum block and hollow Delrin vacuum block.

Selective laser sintering (SLS) machining is an additive manufacturing (AM) technology that uses a laser to sinter powdered plastic materials into a solid structure based on a 3D model. For decades, the SLS 3D printing has been a popular choice for engineers in product development. Low cost per part, high productivity and established materials make the technology ideal for a range of applications, from rapid prototyping to small batch or bridge manufacturing.

The 5-axis CNC machine has been employed for the developing innovations regarding the dual side vacuum clamping block. 5-axis machining involves machinery that can simultaneously shift a tool or part in five different axes. Basic machining is accomplished on three main axes, X, Y and Z, but a 5-axis CNC machine can rotate two additional axis, A and B, providing a multi-directional approach to this cutting tool. The CNC process begins with the development of a 2D vector or 3D solid component CAD design (either at-house or through the design company CAD).

2.5 Machining Method

An acrylic workpiece that possesses high strength and good fatigue resistance was used to conduct the experiments. Specimens were prepared to conduct the experiments under an environmentally friendly end mill cutting process. The cemented high-speed steel tool possesses good physical and chemical properties and has high resistance to wear. The cutting parameters consist of the spindle speed, feed rate and depth of cut based on previous studies. The spindle speed is 9500 RPM and feed rate 1000 mm/min. This study applied the same spindle speed and feed rate parameters, but with a different depth of cut which is 1.5mm. The depth of cut parameter used was lower than previous studies with 2mm.

2.6 Vacuum Clamping System Setup with Different Positions

Figure 3 displays the setup of vacuum clamping on the CNC router table for the machining test with 3 different positions: (a) cross position, (b) distance position and (c) side by side position. The previous study had applied the static position testing and measured the efficiency of the machining performance. This study employs the cross position to determine the critical point positions when external force is applied to the material during the machining process and whether it will affect the clamping force.

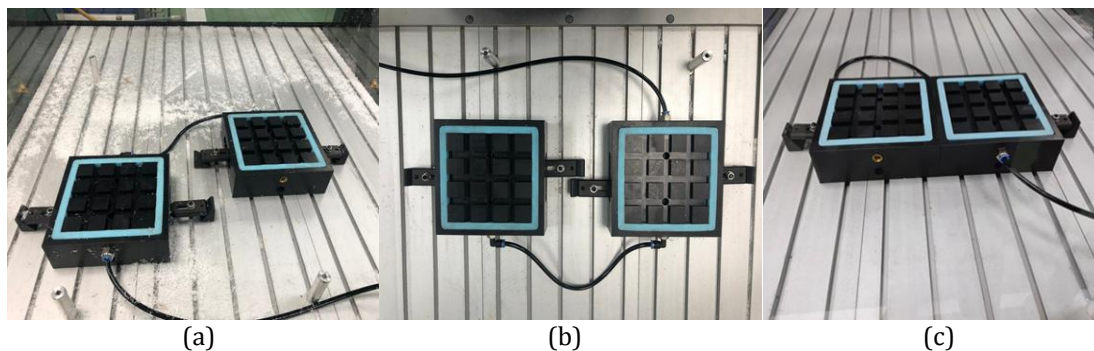

Figure 3. Position of vacuum block, (a) cross, (b) distance and (c) side by side.

2.7 Measurement Depth of Accuracy Testing Using Coordinate Measuring Machine (CMM)

The acrylic plate will proceed to engraving process with design of letters represent Fariza Laboratory, the depth will measure at each top letter indicates sixteen letters of reading. The dimensional measurements have traditionally been in the field of terms because metrological activities are carried out in a temperature-controlled environment, away from thermally stabilised parts [15]. The manufacture activity includes real dimension feedbacks. The

transition to the production process requires a highly controlled, remote and environmentally robust area to conduct the metrology activity using a tightly integrated measuring function [16]. According to standard BS 6808-2&3:1987; coordinate measuring machines. The most important factor in measuring repeatability errors and incorrect measurements is to correctly define, or fail to define, a part alignment. Figure 4 shows the setup experiment for depth of cut.

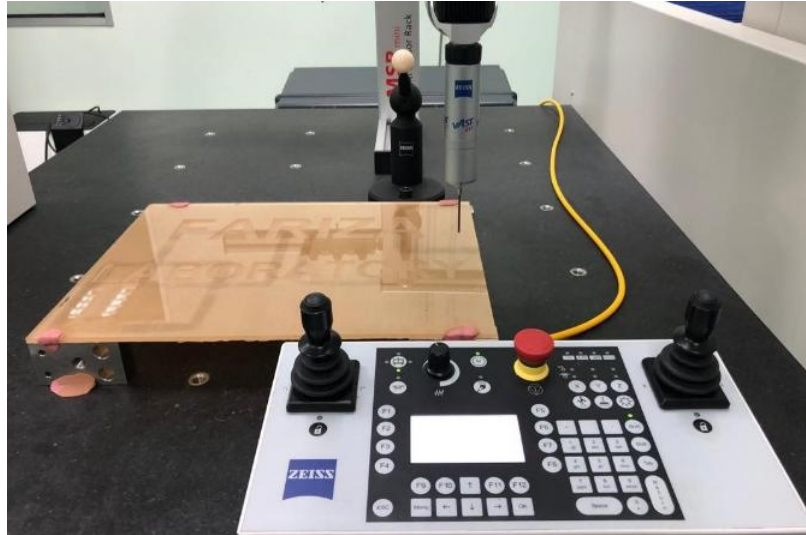

Figure 4. Setup experiment for depth of cut.

2.8 Material Testing Using the Surface Roughness Machine Mitutoyo SJ-410

The surface roughness machine, Mitutoyo SJ-410, was used to directly measure the machined component after the completion of the machining operation. Due to large plate acrylic, the plate cut into four section; top and bottom divided into four pieces, and both side divided into three pieces. Total of fourteen pieces will run under the surface roughness machine. The stylus instrument is a digital type that is widely used for measuring a surface profile. This technique applies a fine diamond stylus with a tip size of approximately 0.1 to 10 μm diagonally to the surface. As the stylus tracks the surface peaks and valleys, its vertical motion is converted to a time varying electrical signal that represents the surface profile [17]. The method follows standard BS 6741-1&2:1987; Glossary of surface roughness term. Stylus instruments are drawn across the surface and generate electrical signals proportional to the changes to the surface [18]. Changes in height can be read directly with a meter or on a printed chart. The type of stylus instrument utilised in this experiment is the true datum. Then, Figure 5 shows the surface roughness test rig setup.



Figure 5. Setup experiment for surface roughness.

3. RESULTS AND DISCUSSION

3.1 Static Analysis of Hollow Delrin and Hollow Polyamide (SLS) Vacuum Block

Figure 6 and Table 1 show that the hollow Delrin vacuum block successfully passed the test due to numerous criteria. Firstly, from the stress graph, the maximum stress of $7.390 \times 10^5 \text{ N/m}^2$ is less than the yield strength of $6.55 \times 10^7 \text{ N/m}^2$. Therefore, the part will not break under this external load. Next, the maximum deformation or displacement is exceedingly small: $3.214 \times 10^{-2} \text{ mm}$.

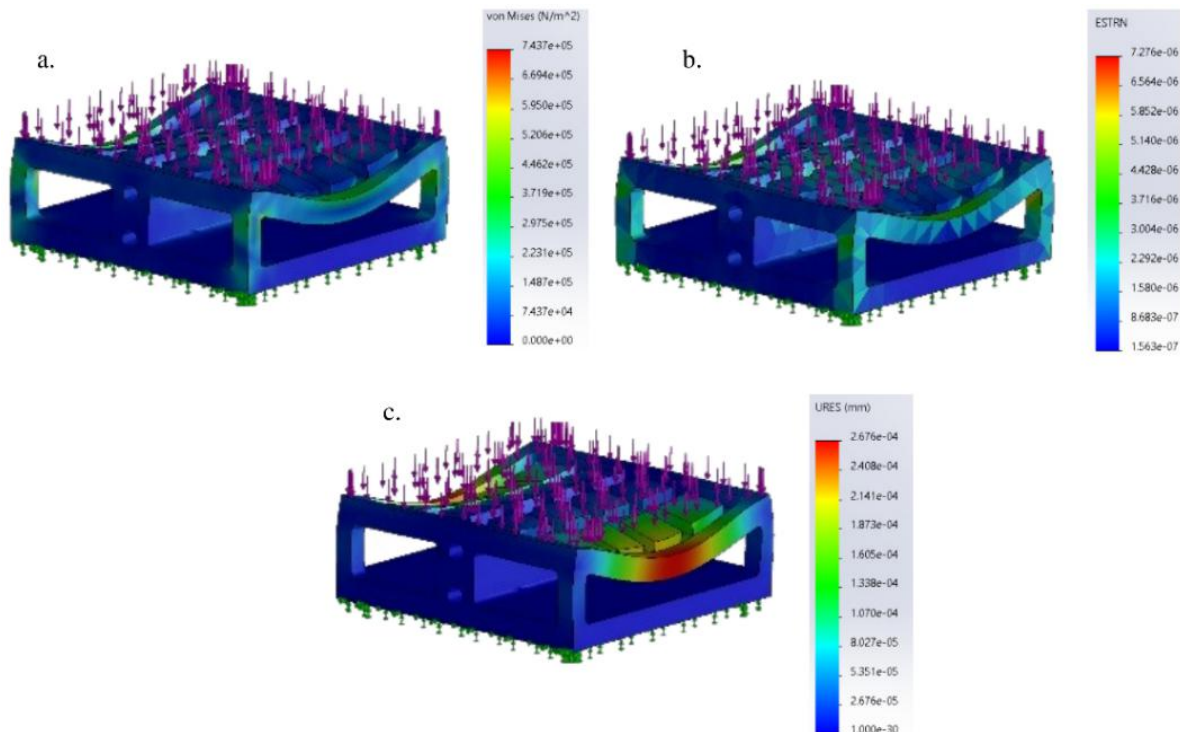

Figure 6. Static analysis results for Delrin hollow, (a) stress, (b) strain and (c) displacement.

Then, Figure 7 and Table 3.1 show that the polyamide vacuum block successfully passed the test due to numerous criteria. Firstly, from the stress graph, the maximum stress of $7.437e^5$ N/m² is less than the yield strength of $1.036e^8$ N/m². Therefore, the part will not break under this external load. Secondly, the maximum deformation or displacement is slightly higher than the hollow Delrin vacuum block: $3.222e^{-2}$ mm.

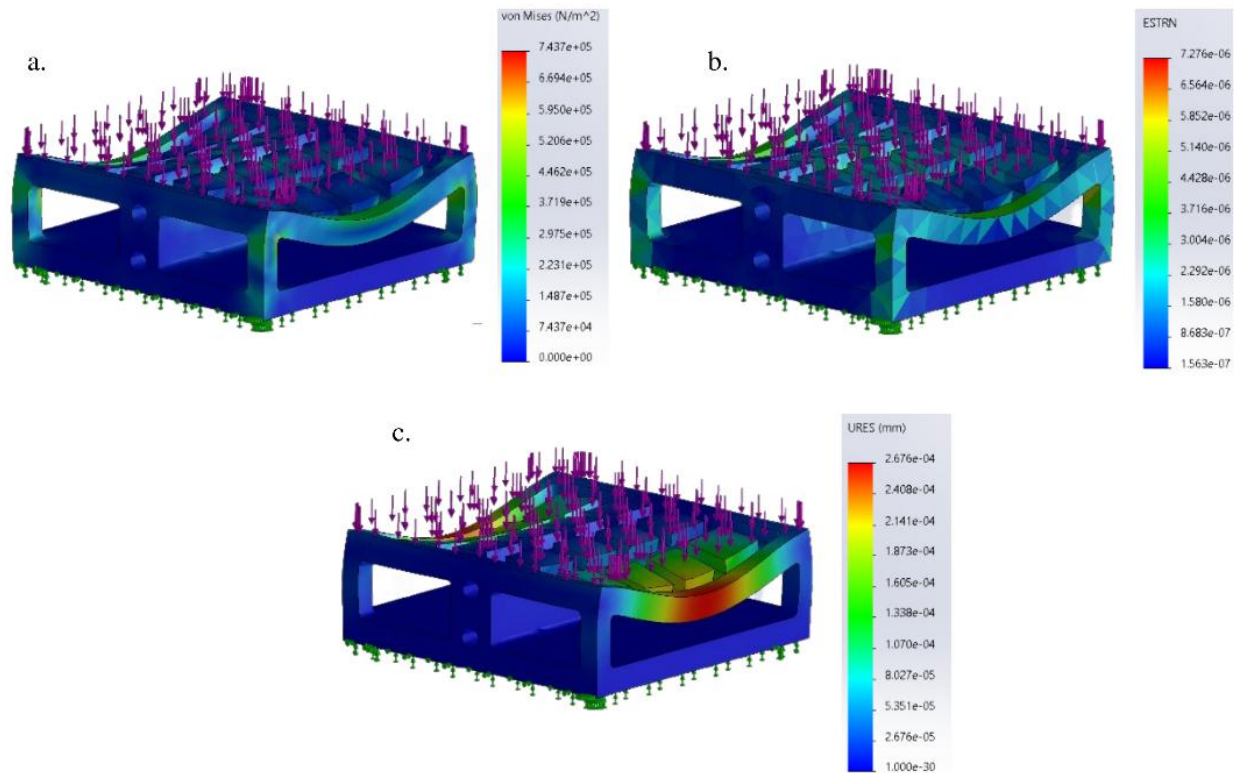

Figure 7. Static analysis results for Polyamide hollow; a. stress, b. strain and c. displacement.

Table 1 Static analysis of hollow polyamide and Delrin vacuum block

	Materials	Stress(N/m ²)	Strain	Displacement(mm)
Max	Delrin	$7.390e^5$	$1.615e^{-4}$	$3.214e^{-2}$
	Polyamide	$7.437e^5$	$1.567e^{-4}$	$3.222e^{-2}$
Min	Delrin	0	$1.387e^{-7}$	$1.000e^{-30}$
	Polyamide	0	$1.026e^{-7}$	$1.000e^{-30}$

Stress and strain are measurements that describe the material failure criteria and behaviour. Stress is the pressure the material sees when a load is responded to. The load is distributed in the material depending on stiffness. Displacement can be defined as the extent to which the model displaces or deflects. Both vacuum clamping blocks are within the acceptable range regarding the stress-strain value under the yield strength value. However, the displacement for both tested models was not within the acceptable range. Hollow polyamide vacuum clamping block was therefore chosen instead of the hollow Delrin vacuum block. The hollow polyamide vacuum block underwent the mechanical structural test, while the solid Delrin vacuum block was chosen to be used for clamping. The static structural analysis of the solid Delrin vacuum block was also analysed. Figure 8 and Table 2 shows the static analysis and the data of the vacuum block.

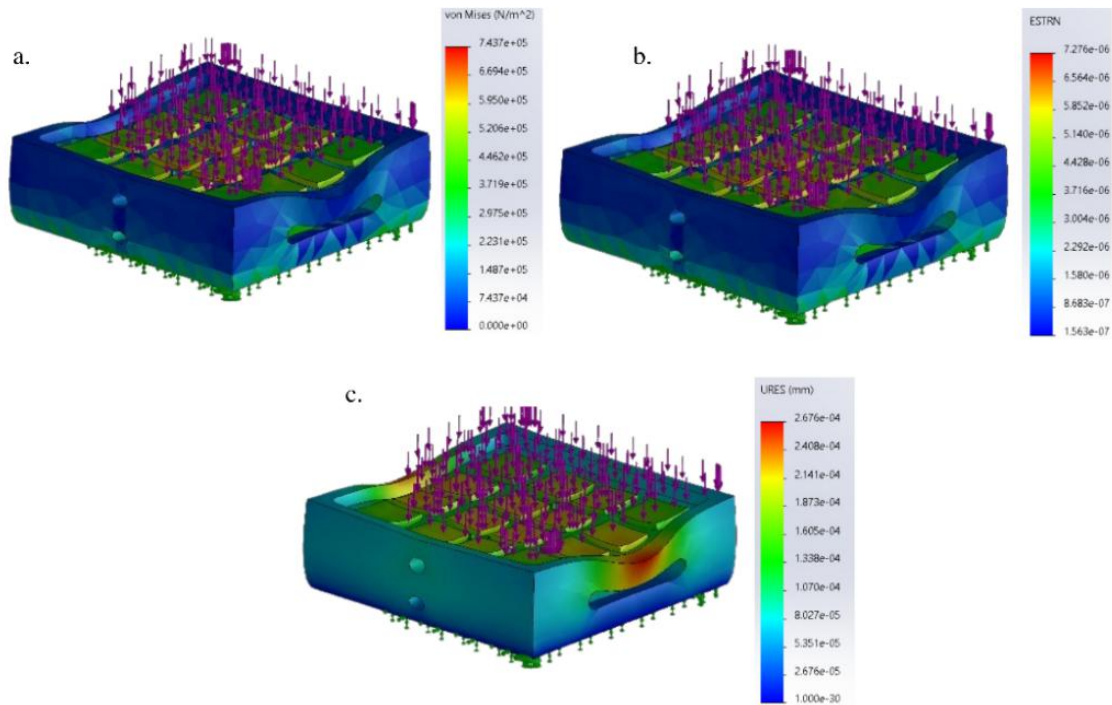

Figure 8. Static analysis results for Delrin Solid (a) stress, (b) strain and (c) displacement.

Table 2 Static analysis of solid Delrin vacuum block

	Stress (N/m ²)	Strain	Displacement (mm)
max	2.268e ⁵	7.276e ⁻⁶	2.676e ⁻⁴
min	0	1.563e ⁻⁷	1.000e ⁻³⁰

Based on these three vacuum clamping blocks, differences can be seen among the use of materials and designs. The displacement graph clearly indicates that the solid Delrin vacuum clamping block presented less distortion than both the hollow polyamide and hollow Delrin vacuum blocks. This could be due to the fact that both vacuum blocks come from the same family of polymers, although the two materials undergo different manufacturing processes. The maximum stress values are $7.437e^5$ N/m², $7.390e^5$ N/m² and $2.268e^4$ N/m² for hollow polyamide, hollow Delrin and solid Delrin vacuum blocks, respectively.

3.2 Results of Functionality Test of the Vacuum System

The pressure began at 70 kPa, and the material was vacuumed, maintained and registered every 2 minutes. The vacuum force can be enhanced if the pressure continuously increases. Thus, the lower the pressure vacuum of the object, the lower the clamping force strength. The experimental goal is to distinguish between the continuous pressure and the effect of the residual pressure. Figure 9 presents the results of the pressure value according to time. The remaining pressure line stayed at 30 minutes per 2 minutes of observed pressure value. Continuous pressure can sustain full pressure while the remaining pressure significantly decreases throughout the first 10 minutes and loses suction pressure. Shown that the vacuum block and vacuum system able to hold max 10 minutes without power supply. Since the clamping force was capable of maintaining the pressure after 30 minutes, the continuous pressure experiment proceeded to the machining process.

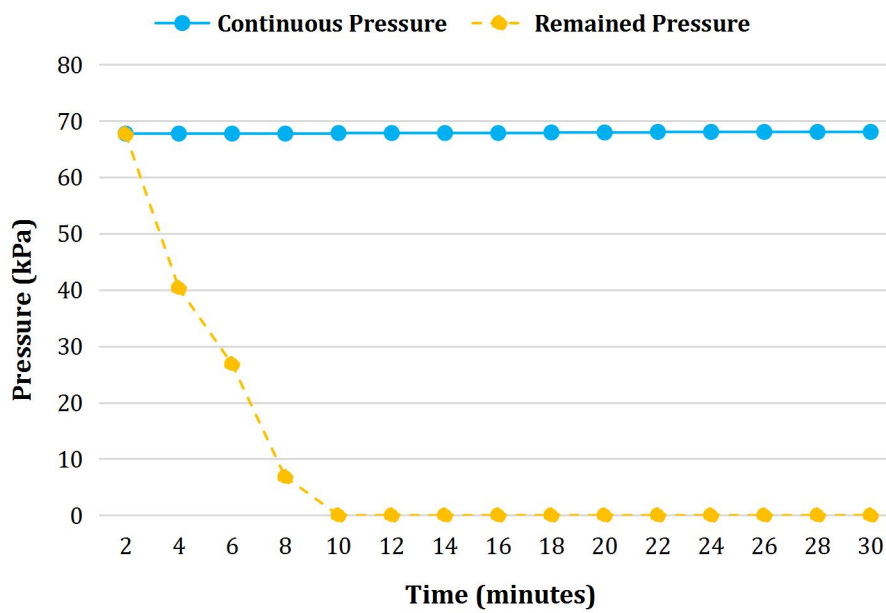

Figure 9. Pressure value by time before the machining process.

Figure 10 illustrates how during the machining process; the vacuum system operates at continuous pressure for about 30 minutes. After 30 minutes, the vacuum force was tested for the cross, distance and side by side positions of the vacuum block to determine whether or not the pressure force will be affected. Pressure began at 70 kPa and slightly decreased due to the rubber which is required to fulfil the vacuum block slotting space. The pressure steadily increased after 5 minutes for all three positions. The table below also indicates that no changes are present in the pressure force during the machining process when the external force applied to the clamping force of the vacuum block occurs. The value of the pressure force for all positions was successfully held at 68 kPa after 25 minutes of the completion of the machining process.

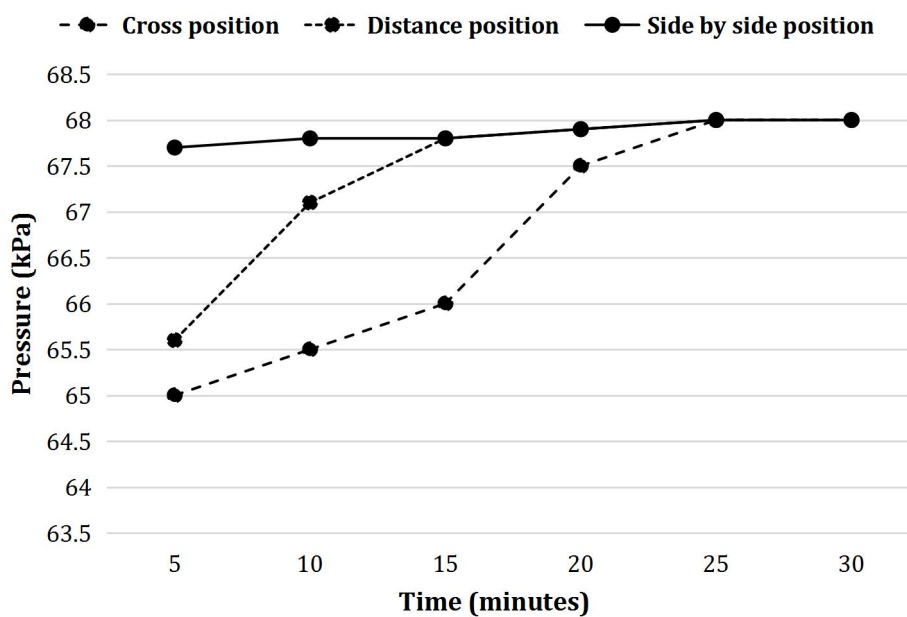

Figure 10. Continuous Pressure with different position during machining process over time.

3.3 Analysis of the Experimental Results for the Depth of Accuracy Using the Coordinate Measuring Machine (CMM)

Based on Figure 11, the depth of accuracy for three placement types was applied to 16 points, in each alphabet point. It was discovered that among all the effects, the depth of cut has a vital impact on dimensional accuracy. The experiment revealed that all point markers do not reach constant depth of cut. This is related to the higher vibration which contributes to the decreased accuracy of the depth of cut. Overcut represent that the acrylic plate vibrates upward forcing the cutting tool to feed more than the actual dimension, while undercut represent the acrylic vibrates downward evades the cutting feed.

Cross position of alphabet R, I, and Z is on top right side has closer value to actual dimension which has vacuum block underneath it. Alphabet B, O, R1 and A3 also closer to actual dimension on left bottom side position and on top of vacuum blocks. Shown that the plate where have support will produce less vibration rather than alphabet with no support under it. However both area still in undercut value which mean less than 1.5mm. Distance position of vacuum blocks shows alphabet I, Z, B, O, R1, A3, T, O1, and R2 has more counted alphabet that closer to actual dimension. Most of the alphabet position on centre plate shows that has strong support from the vacuum blocks. Side by side position of vacuum blocks has the most unstable value of depth of cut. Alphabet F, A, R and I on top left side, alphabet A1, O1, R2 and Y on right side, and alphabet L, A2 and B on bottom left side are far more further than actual dimension. The result may cause by vibration due to unsupported area and located near to plate edges. Conclusion, among the position of the vacuum block, distance position shows most alphabets near the actual dimension even there are a few area have vibration. In actual machining, it recommended to have support to reduce the vibration.

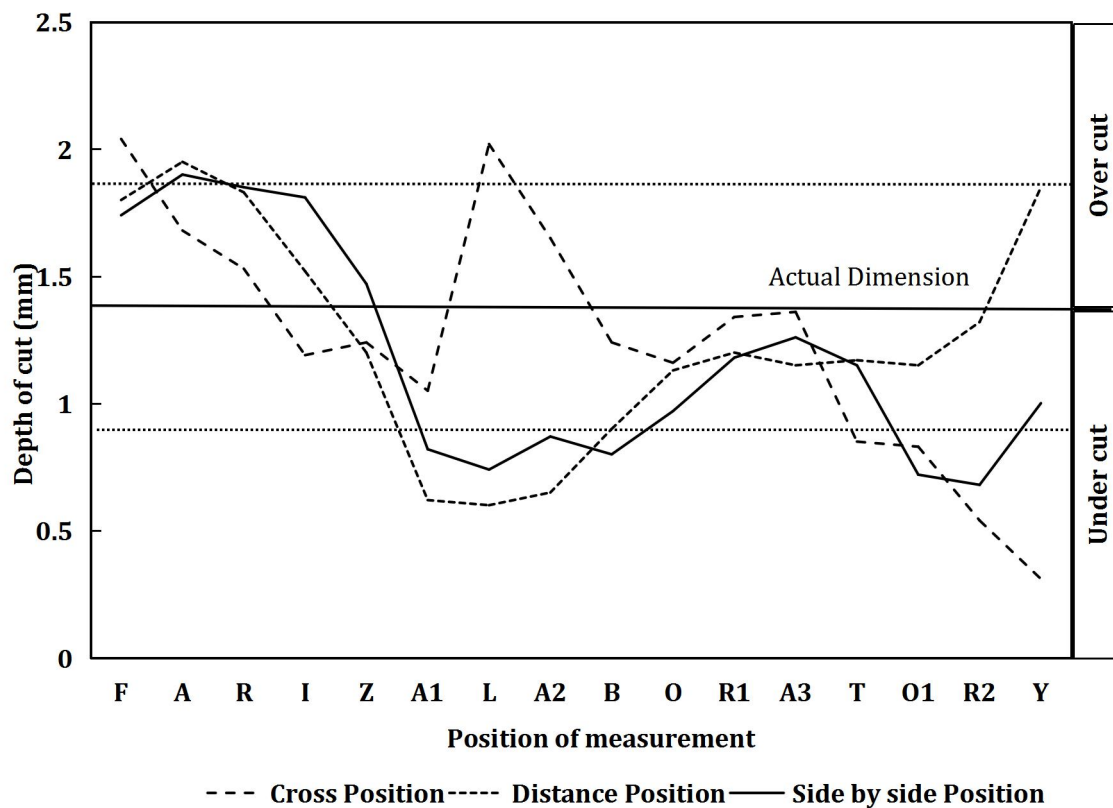

Figure 11. Depth of accuracy data.

3.4 Analysis of Experimental Results for Surface Roughness Using Mitutoyo SJ-420

The starting point of the side milling profiling test was at the left-side of the material, which is in the clockwise direction. Testing was repeated three times: the first was for 0.3 mm mean depth of cut, the second was 0.6 mm and the third was 1.5 mm. The top and bottom sides were divided by four, while the left and right sides were divided by three.

Figure 12 represent result of arithmetic value for three positions of surface roughness test. The graph shows on the left section that all three positions has ascending higher then the others three section. As mention above, left side of the acrylic plate is a starting point profile cutting. On other side, top, right and bottom section shows the value still maintain in low value. Cross position on point L3 value of 9.358 is the highest, while side distance position still high but only 3.43 value. Point L3 located at left section top side, which cross position the vacuum block placed on left section bottom side, meaning point L3 have no support underneath it. Cutting profiling with mid-air workpiece, the possibility for the workpiece to vibrate is high because L3 point does not have support or holder during the process.

Furthermore, in case for side by side position of the vacuum block placed centre of acrylic plate workpiece leaving a distance from clamp area to the edges of the workpiece. Seemly at starting point L3 has high value of 5.288, but right section at R3 is 0.83, R2 is 1.179 and R1 is 0.729. There is a contrary value of both side even has same distance from cutting path to area of vacuum block clamp. Showing same affect with cross position which is the starting line.

Lastly, side distance position at point L3 has the lowest value at 3.43 and the lowest average value with 1.3 showing the position are the most stable. Among the three position, side distance position are the least that can bend the workpiece by hand. Using only two block, optimum result must clamp the workpiece equally distribute to all side regarding to avoid the vibration while cutting process. To sum up, side distance is the best result among three position proposed of surface roughness test in this study.

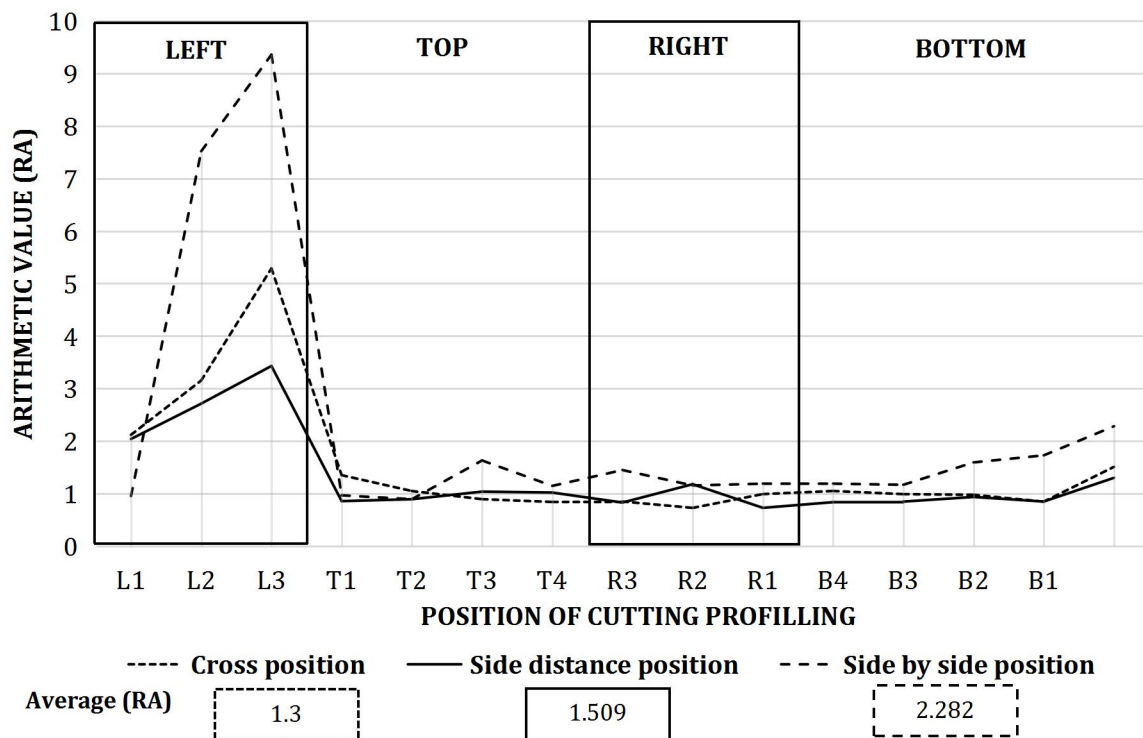

Figure 12. Surface roughness with different vacuum block positions.

4. CONCLUSION

The method of clamping design and testing for practical vacuum clamping, precision depth for engraving, and surface roughness lateral profiling were accepted in this experiment. The acrylic plate was subjected to two separate condition techniques continuous and remained pressure. The vacuum clamping situation with a given cutting time will estimate the acrylic plate during the machining process, with a pressure drop by only 2.0 kPa from 70 kPa. In short, air dropped in the vacuum clamping testing is able to keep the workpiece in place and steadily improved the clamping. This experiment has proven to be useful in ensuring that the vacuum is properly clamped during side milling and graving of acrylic. Analysis from depth of accuracy and surface roughness test conclude that side distance position satisfy both result.

ACKNOWLEDGEMENTS

This work is partially supported by Universiti Teknikal Malaysia Melaka (UTeM) and the Malaysia Ministry of Higher Education for the financial funding under Grant No. FRGS/2018/FTKMP-AMC/F00387.

REFERENCES

- [1] Ma X., Wu D., Gao Y., Liang X., Huang S., Dong Y., *Int. J. Adv. Manuf. Technol.* vol **95**, (2018) pp.785–795.
- [2] Zhang F., Ren L., Liao D., Liu A., Wang J., *Earth Environ. Sci* (2021).
- [3] Ab Wahab N., Martius J.L., Nordin A.K., M. Zahari M., Najib S.M., Saifizi M., *J. Phys. Conf. Ser.* vol **1529**, (2020).
- [4] Bhirud N.L., Gawande R.R., *Arch. Mech. Eng.* (2017).
- [5] Delpont L.D., Conradie P.J.T., Oosthuizen G.A., *Procedia Manuf.* vol **8**, (2017) pp.338–344.
- [6] Wahab N.A., Basharudin S.B., Boejang H., Ruslan E., Hadi D.A., Nasir N.S., *ARPN J. Eng. Appl. Sci.* vol **14**, (2019) pp.2433–2436.
- [7] Rubio-Mateos A., Casuso M., Rivero A., Ukar E., Lamikiz A., *Chinese J. Aeronaut.* (2020).
- [8] Salim M.A., Saad A.M., Rosszainily I.R.A., Wasbari F., Masripan N.A., Yusof N.M., M.H.A. Al-Mola, *Int. J. Nanoelectron. Mater.* vol **13**, (2020) pp.449–460.
- [9] Barzegari M.M., Ghadimi M., Momenifar M., *Appl. Energy*, **263**, (2020) pp.114-663.
- [10] M. T, K. S, K. I, G. GA, A. M, *J. Appl. Mech. Eng.* vol **06**, (2017) pp.6–15.
- [11] Sari K., Utomo A.B.S., Abraha K., Roto, Kartini E., Yulianti E., Suharyadi E., *Int. J. Nanoelectron. Mater.* vol **13**, (2020) pp.1–8.
- [12] Hajimiri H., Abedini V., Shakeri M. M., Siahmargoei M.H., *Int. J. Adv. Manuf. Technol.* (2018).
- [13] M'Saoubi R., Axinte D., Soo S.L., Nobel C., Attia H., Kappmeyer G., Engin S., Sim W.M., *CIRP Ann. - Manuf. Technol.* (2015).
- [14] Soldner D., Greiner S., Drummer D., Steinmann P., Mergheim J., *Addit. Manuf.* (2020) pp. 101 676.
- [15] Mussatayev M., Huang M., Beshleyev S., *Int. J. Adv. Manuf. Technol.* vol **111**, (2020) pp.537–547.
- [16] Echerfaoui Y., El Ouafi A., Chebak A. A., *Int. J. Precis. Eng. Manuf.* vol **19**, (2018) pp.1115–1124.
- [17] Yuan Y., Jing X., Ehmann K.F., Zhang D., *Int. J. Adv. Manuf. Technol.* vol **95**, (2018) pp.1655–1664.
- [18] Urbikain G., de Lacalle L.N.L., *Simul. Model. Pract. Theory* vol **84**, (2018) pp.161–176.

