

# Capacity enhancement in indoor environment by hybrid combiner circuit of multinetworks operator

Suzi Seroja Sarnin<sup>a</sup>, Wan Norsyafizan W. Mohamad<sup>a,\*</sup>, Mohd Yusdee Yusof<sup>a</sup>, Ros Shilawani S Abdul Kadir<sup>a</sup>, Mohd Nor Mad Tan<sup>a</sup>, Norsinnira Zainul Azlan<sup>b</sup>, Zarina Baharudin Zamani<sup>c</sup>

<sup>a</sup>School of Electrical Engineering, College of Engineering, Universiti Teknologi MARA, Shah Alam, Selangor, Malaysia.

<sup>b</sup>Department of Mechatronics Engineering, Kulliyah of Engineering, International Islamic University Malaysia, Jalan Gombak, 53100 Kuala Lumpur, Malaysia.

<sup>c</sup>Faculty of Electronic and Computer Engineering, Universiti Teknikal Malaysia Melaka, Hang Tuah Jaya, 76100 Durian Tunggal, Melaka, Malaysia.

(Communicated by Madjid Eshaghi Gordji)

---

## Abstract

This study focuses on providing a solution for a mobile service provider with Multi Network Operators (MNOs) to provide an excellent service attended by thousands of Mobile Subscribers (MS) at Nasional Bukit Jalil Kuala Lumpur Stadium in Malaysia using a single multi-beam antenna via a hybrid circuit. The Hybrid Combiner (HC) is the solution used to combine multiple MNOs in order to minimize space and cost while maintaining the aesthetic value of the national stadium. During a significant incident, MS users may encounter difficulties accessing the service due to network congestion. In this case, MNOs will need to add capacity to meet the demand for data transmission and voice call transactions. In the current situation, MS users have received poor service because they are unable to connect to the internet or make phone calls while attending a major event at a stadium. MS users will be able to access the network and enjoy live feeds via Facebook (FB) and other software applications without delay or interruption, as well as voice call congestion, following the implementation of the proposed solution. Using the Planning Methods, the results of the proposed solution will be compared to the results of the Walk Test and the coverage simulation analysis. Data statistics obtained from MNOs will explain the solution's effectiveness in terms of signal quality level, with the Signal to Noise Ratio (SINR) recorded at -95 dBm below the threshold of -85 dBm to prevent interference with MS users. The Resource Block (RB) Utilization shows that all sectors are utilized at less than 70% of total available capacity, indicating that the congestion level is manageable and MS users can access the network without interruption. A key factor in the proposed study, known as Hybrid Combiner Circuit of Multi Network Operator for Capacity Enhancement Solution in Indoor Environment, is fast deployment, low maintenance, and a shared solution between MNOs.

**Keywords:** Mobile network operator(MNOs), In-Building coverage (IBC), Multibeam antenna system (MAS) and Multibeam RF antenna

---

\*Corresponding author

Email addresses: [suzis045@uitm.edu.my](mailto:suzis045@uitm.edu.my) (Suzi Seroja Sarnin), [syafizan@uitm.edu.my](mailto:syafizan@uitm.edu.my) (Wan Norsyafizan W. Mohamad), [yusdee@edotcogroup.com](mailto:yusdee@edotcogroup.com) (Mohd Yusdee Yusof), [ros885@uitm.edu.my](mailto:ros885@uitm.edu.my) (Ros Shilawani S Abdul Kadir), [mohdn829@uitm.edu.my](mailto:mohdn829@uitm.edu.my) (Mohd Nor Mad Tan), [sinnira@iiium.edu.my](mailto:sinnira@iiium.edu.my) (Norsinnira Zainul Azlan), [zarina@utem.edu.my](mailto:zarina@utem.edu.my) (Zarina Baharudin Zamani)

Received: June 2021 Accepted: September 2021

### 1. Introduction

The number of mobile subscriber (MS) in Malaysia continues to rise year after year. The number of MS users has risen to 11 million, with a quarterly increase of 100 thousand to 200 thousand [21]. Mobile internet users accounted for 8.5 million, or roughly 76 percent of all MS users in Malaysia. The study focuses on addressing the demand of MS users, whether post-paid or pre-paid, whose behaviour is "hungry" for continuous connectionless internet access in an indoor environment, such as a stadium. This paper describes how a hybrid combiner circuit of Multinetworks Operator [20] can improve capacity in an indoor environment. An important key taker to be focused on in this study is a combining circuit with an acceptable loss to see how a multinetworks operator's hybrid combiner circuit improves capacity in an indoor environment is the best way to cater to a large number of MS users during peak time in [10, 19, 16]. Multiple MNOs can use a specially designed circuit combiner to pump in multiple technologies such as 3G-UMTS and 4G-LTE by using a multi beam antenna with a wideband frequency range of 1710 MHz to 2690 MHz. This paper will present an analysis, evaluation, and Walk Test (WT) to demonstrate the Multibeam RF Antenna System's effectiveness (MAS) [18, 1, 2, 8]. Using the Planning Methods, the results of the proposed solution will be compared to the results of the Walk Test and the coverage simulation analysis. Data statistics obtained from MNOs will explain the solution's effectiveness in terms of signal quality level, with the Signal to Noise Ratio (SINR) recorded at -95 dBm below the threshold of -85 dBm to prevent interference with MS users. The Resource Block (RB) Utilization shows that all sectors are utilised at less than 70% of total available capacity, indicating that the congestion level is manageable and MS users can access the network without interruption [22].

### 2. Methodology

Figure 1 shows the flowchart and procedure for this research.

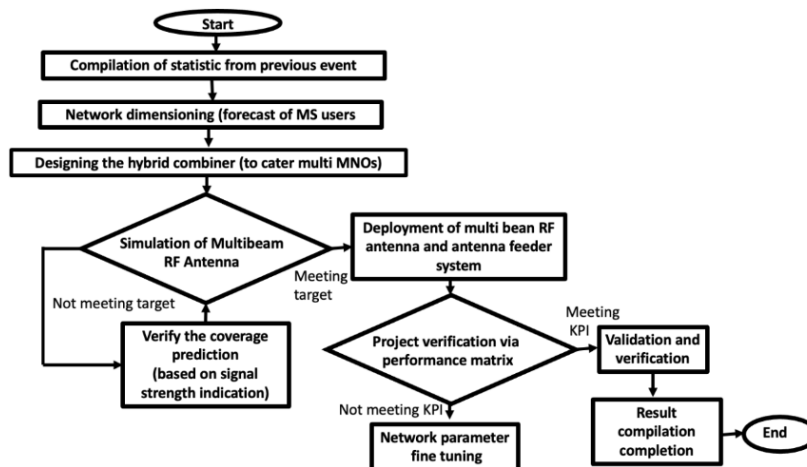

Figure 1: Flow Chart of implementing the hybrid combiner circuit MNOs in MBA

The activities of the research study explain as below:

- i. The study begins by compiling data statistics from serving cells that serve inside the stadium, which are typically provided by Cell On Wheels (COWs). After the MAS is deployed or implemented inside the stadium, this data will be used as a reference) to be compared [17]. The comparison will be based on the reference, which will be the target and priority KPIs.

Because COWs cannot be deployed inside the stadium, the KPI for before implementing MAS will be taken from another event with a large number of people for this study.

- ii. Next, the dimensioning of HC to design the circuit depicted in Figure 2 included a few elements and components, such as a Hybrid Combiner (HC) and a diplexer, to allow MNOs to combine multiple technologies. The In-Building Solution (IBS), which uses RF Antennas at various points and levels of the building, inspired the design of this combining circuit.

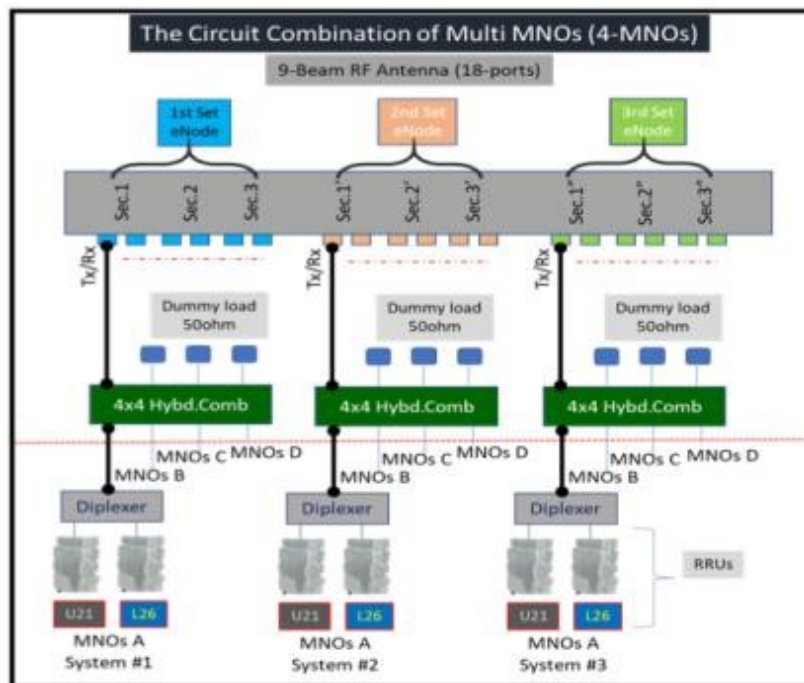

Figure 2: Circuit Design of Combining Multi MNOs in MBA

- iii. Then, the link budget is important thing to be considered when designing the cell in a mobile network. A radio link budget the sum of the power transmitted along the system and finally defined the signal strength at the far end of the receiver location. The iBwave system automatically calculates the link budget by entering antenna specification parameters such as antenna gain, antenna pattern, feeder cable length and type, combiner specification, and clutter type such as stadium layout drawing, frequency band, and technology used [5].
- iv. iv. After that, iBwave is the Planning Tools used to simulate the case study are of the indoor type, focuses on the indoor coverage area. A few parameters, such as Antenna Pattern (where provided by the manufacturer), antenna gain, and antenna location height, must be entered as data into the Planning tools. Furthermore, the stadium layout must be defined in the iBwave according to the floor plan, which includes the zones of capacity or the number of MS to be served in the stadium [9, 12, 14, 4]. Because the stadium is a closed area that will be served by the MAS, interference from other nearby sites should be minimal. Figure 3 shows a sample of the iBwave coverage plot. The signal strength legend is shown so that the signal strength can be displayed based on the serving area.
- v. Then, evaluate the MAS's effectiveness in addressing the large crowds of spectators in the open stadium for football and track games activities, whereas the closed stadium for badminton

Figure 3: Coverage Plot Simulation by iBwave at stadium

games is addressed via an In-Building Coverage (IBC) system because the RF antenna can be easily mounted on the roof or walls that surround the games area. Figure 4 depicts a coverage heat map that describes the radiated signal that was simulated using the Planning Tools (iBwave) based on the parameter settings during the simulation activity. Before simulating the signal, the stadium layout diagram is used as a reference and updated in the system. The

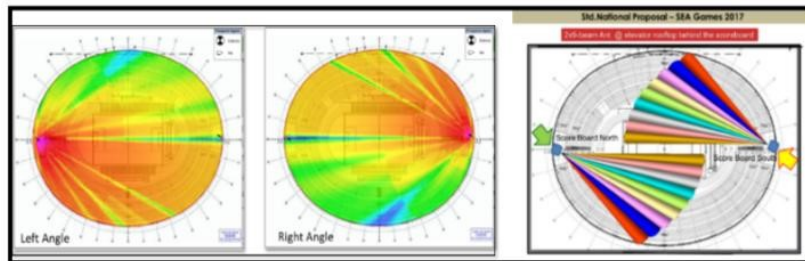

Figure 4: Coverage Plot Prediction (Heat Map)

proposed location and layout diagram for the deployment of MAS is depicted in Figure 5. The proposed location for grooming all RRUs and BBUs is 33 m away from the MAS, with the connection from RRUs to BBUs using Common Public Radio Interface (CPRI) cable via Dense Wavelength Division Multiplexing (DWDM) [11].

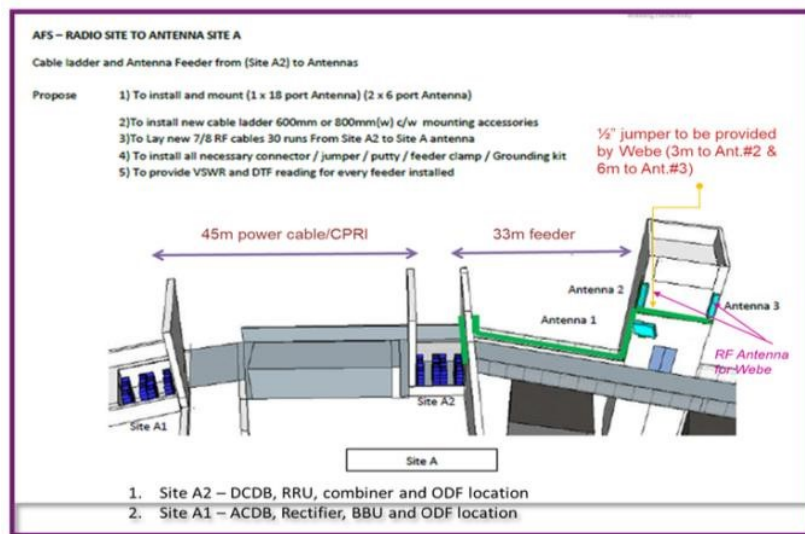

Figure 5: The MAS Location Layout Diagram

vi. Finally, the Hybrid Combiner, also known as an RF combiner, is used to combine all four MNOs operating on the same MAS of these five beams, each with its own frequencies for 3G-2100 MHz and 4G-2600 MHz. The use of HC will result in a 6 dB loss, but because the coverage goal is not for a larger and more extensive footprint, this HC is sufficient and feasible. EIRP is crucial in determining the targeted signal. Adjusting the antenna gains to account for the various path losses results in a balanced 5-beam system in terms of Equivalent Isotropic Radiated Power (EIRP). Figure 6 depicts the Stadium combining circuit of 4-MNOs using 5-beams MBA. [3].

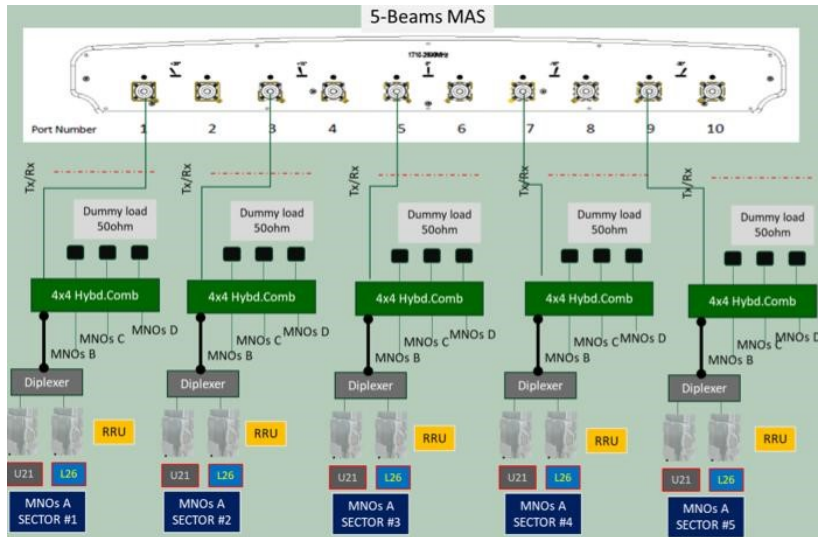

Figure 6: Hybrid circuit of 4-Telcos with 5-beams MAS

### 3. Results and discussion

#### 3.1. Circuit switch and packet switch analysis

The results and findings from the MAS implementation in Stadium Nasional Bukit Jalil demonstrate the efficacy and efficiency of the studies. In summary, the overall result compiled from the SEA Games 2017 opening and closing ceremonies held on August 19th, 2017 at Stadium Nasional Bukit Jalil is shown in Figure 7 for Voice Call via Circuit Switch (CS) and Figure 8 for Data Transaction via Packet Switch (PS) as a comparison before and during the event. Figure 7 depicts the Circuit Switch’s traffic before and during the stadium event. The Erlang value skyrockets, indicating that more users can be kept on board for the duration of the programme. Erlang’s value increases from 243.91 to 512.02 for 2G and from 2182.31 to 3311.91 for 3G. The channel’s bandwidth is reserved for information flow in circuit switching. In order to ensure data delivery on time, the minimum circuit capacity must be the highest flow in the transmission rate. Figure 8 depicts a comparison of data flow before and during the opening ceremony event. The multi-straight system has significantly increased overall data transfer for mobile users, both uplink and downlink, for the day. The 2G system grows from 1.23 to 3.28 GB, while the 3G system grows from 311.72 GB to 450.6 GB and the 4G system grows from 957.4 GB to 1711.3 GB.

The CS increased by 57 percent and traffic increased by 70 percent in the case of PS, including both 3G and 4G technologies. There are 58,000 customers in the area, including a number of Celcom MS subscribers. In terms of capacity, 20 cells recorded over 70% for 4G cells and 61 for 3G cells. According to most high-hour statistics, on-site user feedback indicates that 1 Mbps 4G and 600 kbps 3G are available. One of the peninsular countries is seeing an increase in the demand for broadband satellites. The next satellite system must provide increased access and output while simultaneously lowering costs per Mbps. To meet performance and requirements, a multi-beam satellite system must be used over the coverage region. Except for the Packet Switch Call Set-up Suitcase and PS drop, which are contributed by a temporary site named BKTJALILBAY1, the delay in Transmission Control Protocol (TCP) for WhatsApp for more than 1 second is considered normal (s). The case has been escalated to Huawei and its operations team for further investigation. On the Web and in streaming KPI, even major attempts are detected.

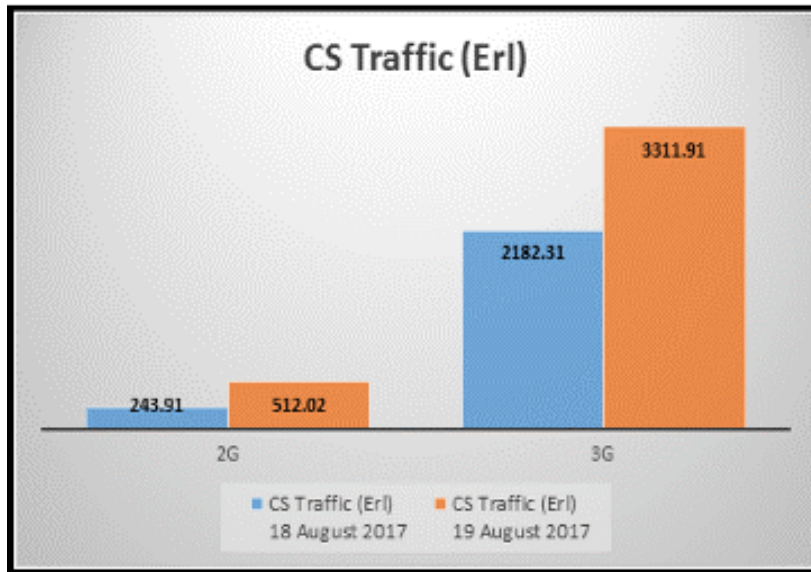

Figure 7: Packet Switch (PS) Traffic during Opening Ceremony in Stadium Nasional Bukit Jalil

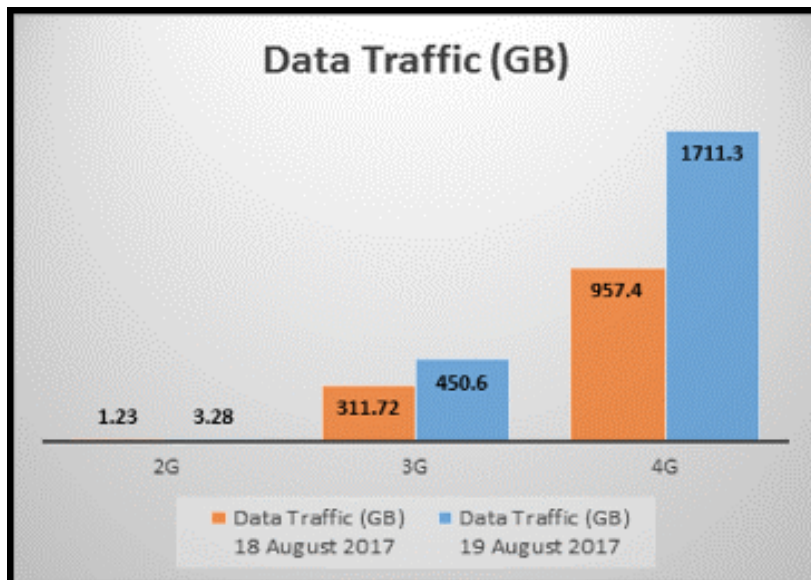

Figure 8: Packet Switch (PS) Traffic during Opening Ceremony in Stadium Nasional Bukit Jalil Kuala Lumpur, Malaysia

3.2. Resource block utilizatio

Figures 9 and 10 show the percentile numbers of MS Users captured of each Cells/Beams of MAS obtained from the major event held in Stadium Nasional Bukit Jalil. The results show that the 9-beam sectors are performing optimally during the event’s peak hours. Three beams out of nine were used at 70 percent of their capacity, while the others were only used at 40 percent.

The results reveal that the question of cellular congestion can be managed and the traffic demand from MS users can be addressed during large numbers. To enhance cell utilization, the Optimisation activity requires either a physical adjustment of the network or parameter tuning, such as RF panning or tilting antenna, or a parameter setting software command, to improve network quality or to ensure equal distribution between all Multi Band 9-band Antenna.

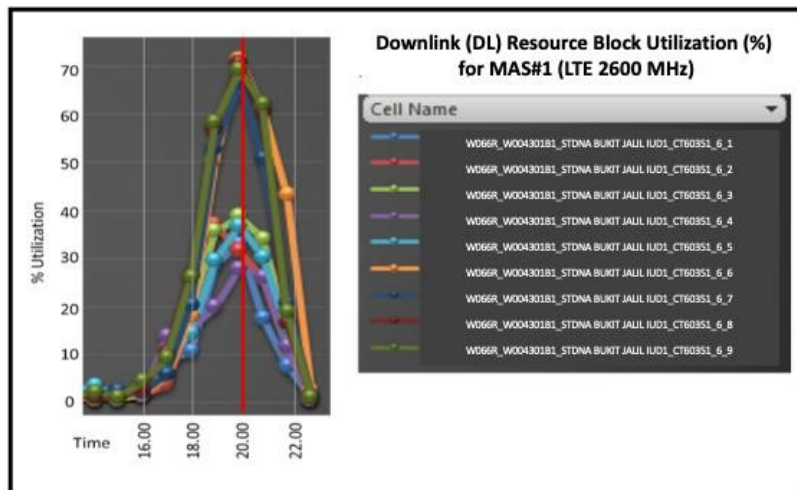

Figure 9: Resource Block Utilization for MAS no 1 Std. Nasional Bukit Jalil, Kuala Lumpur, Malaysia

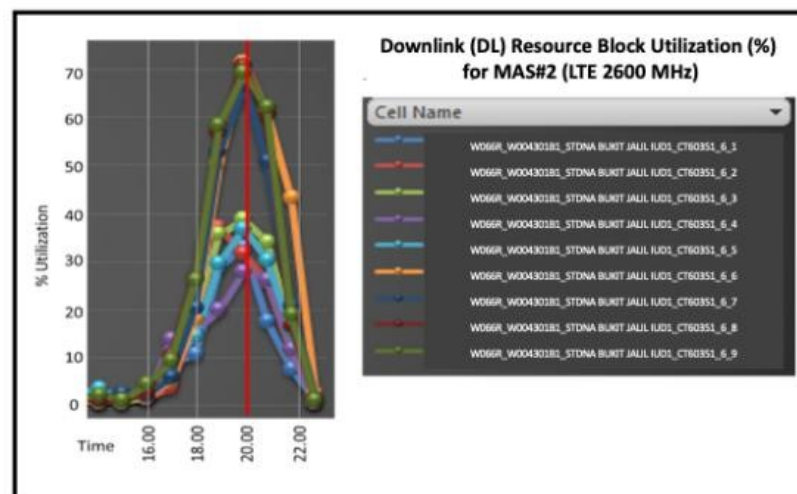

Figure 10: Resource Block Utilization for MAS no 2 Std. Nasional Bukit Jalil, Kuala Lumpur, Malaysia

### 3.3. Metric of uplink (UL) interference

Figure 9 demonstrates that the level of interference is tolerable, in which users still benefit from network access during peak hours of the event. The SINR/SNR target output is about -125 dBm for the developed combination circuit. The findings of the MNOs MAS1 during the stadium event are shown in Figure 11. The results reveal that the greatest interference level of less than -95 dBm has been measured during peak hours. At this level, the interference level can be concluded by using the offered remedy in a reasonable and modest manner. Even amid big crowds and at peak hours of the event, MS users still experience great service. The Literature Review from the previous chapter shows that the study objective is achieved and that it may be used as a basis for future use. The research objective is achieved.

### 3.4. Performance analysis of MAS versus planning tools output against walk test (WT) results

The combined circuit's design is critical in order for multiple MNOs to be used on a single MAS unit. The Planning Tools must be entered by using the recommended parameters such as antenna height, gain, beam width, connection numbers for the specified project. Figure 12 illustrates the

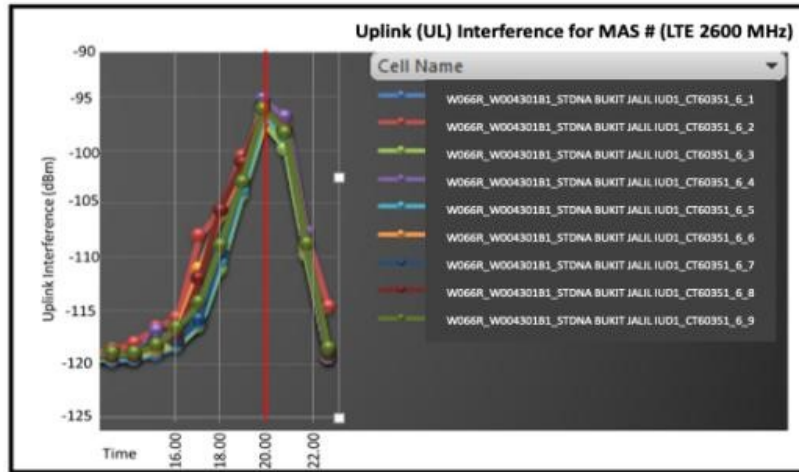

Figure 11: SINR/SNR UL Interference Level during event for MAS no 1

Multibeam Antenna coverage prediction from iBwave. The graphic is based on the input of the parameters of the site survey report. The findings of the coverage plot demonstrate that the MBA on the edge (both edges) of the stadium serves nearly all sitting positions at a maximum serving signal strength of -75dBm in the stadium.

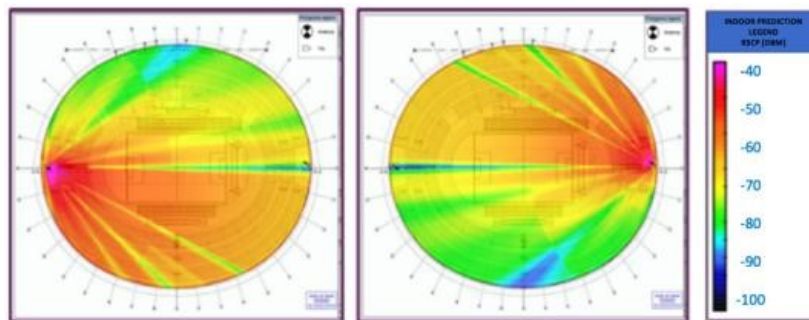

Figure 12: 3G Coverage Prediction Plot by Planning Tools (iBwave)

The comparison is then contrasted with the results from the Walk Test as illustrated in Figure 13. The graphic is a benchmark reference to the signal strength from the MAS. On the close end of the MAS, the 1st sector has been able to serve the area with a strong signal from MS users. The further the MAS seats are less weighty and the difference between the MAS and the MAS is more proportional, MS Users shall be given overlapping coverage between both MASs and the MNOs in order to prevent poor quality services, such as drops, by assigning the neighbour assignment in this overlapped area. The next cell assignment is carried out on-site commissioning using the software set-up in the MNOs system.

The benchmarking from the coverage prediction will then be validated using the Nemo Handy tools during the Walk Test activity. As a result comparison, the results for 3G and 4G are shown in the figures below. Figures 14,15 and 16 show the results of a Walk Test over 3G network of KPI RSCP for three MNOs (Celcom, Digi, and Maxis) compared to Coverage Prediction propagate over the iBwave tools. According to the results, the coverage strength generated by the MAS is nearly identical for those three MNOs. This is to ensure that the results meet the desired KPI as planned and forecasted.



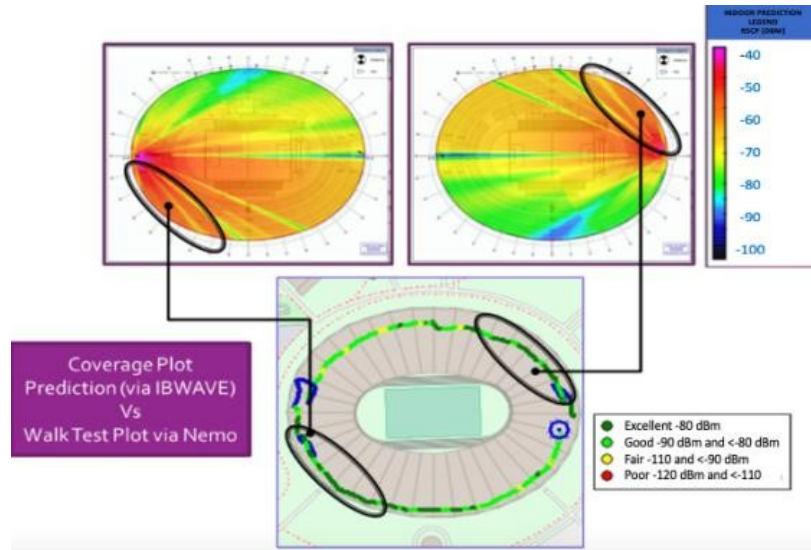

Figure 13: Walk Test Analysis in Stadium

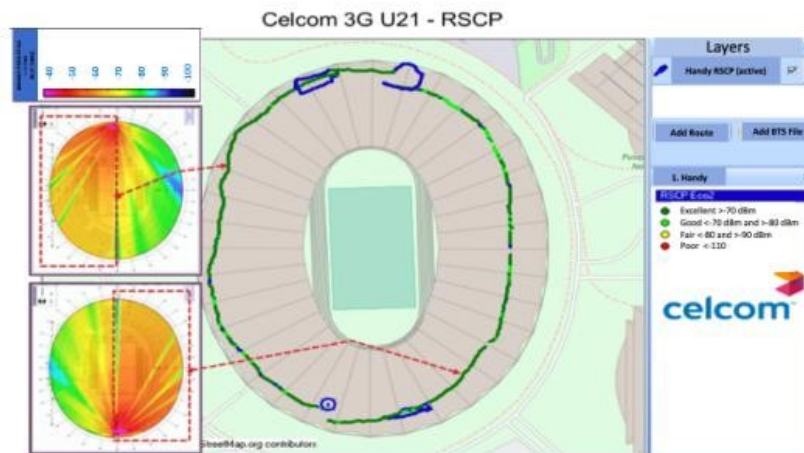

Figure 14: Walk Test Coverage Plot (MNO-Celcom)

Figures 17–19 depict the EcNo 3G Walk Test results for MNO (Celcom, Digi, and Maxis) quality. The network quality, as well as the power and quality received by the receiver, are both based on and reflected. It is also based on the transition from one cell to the next (soft transfer). Signal quality can be improved through optimization, in which network parameters are tweaked and high-quality service in poor reception areas is maintained.

### 3.5. Analysis performance of multi beams antenna versus COWs method used by MNOs

Deployment is equal to the 6-unit standard-site deployment of this 2-unit multi-beam antenna (MAS no 1 and MAS no 2). In the term of costs for use, maintenance and backhaul connectivity, Less Capex and Opex for MNOs. Mobile users receive good service throughout the event’s peak hours. Theoretical for the ideal situation can be taken from the formula as given in Figure 15 for the total number of MS users to be serviced during this event. The total MS users of each MNO are also classified into This is considered into consideration.

The total hourly traffic is shown in Table 1. During peak hours, Digi has the highest traffic with 1.2 Gbps data transactions. For 10-hour periods, mobile network users use a total of 16.998 Gbps of

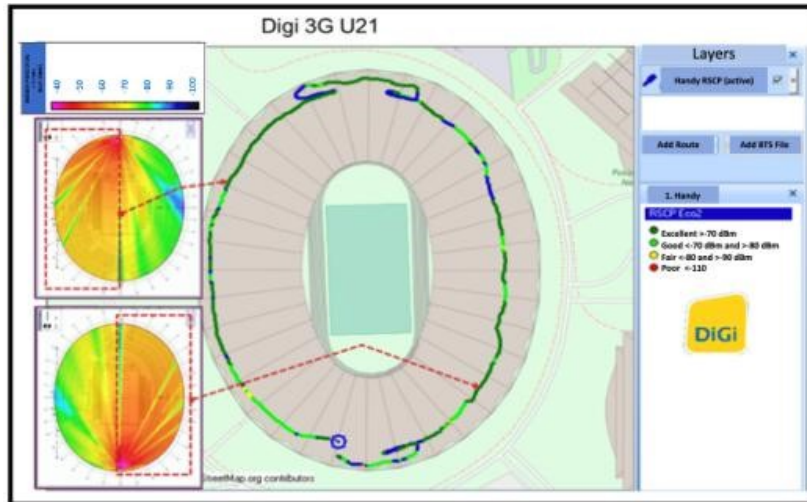

Figure 15: Walk Test Coverage Plot (MNO-Digi)

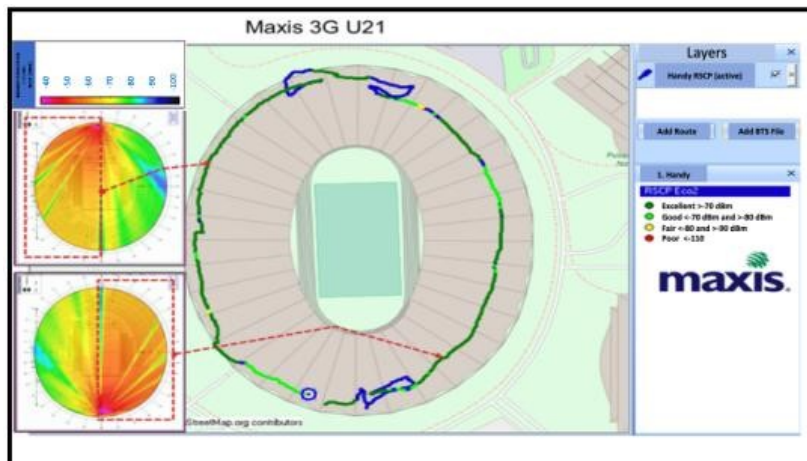

Figure 16: Walk Test Coverage Plot (MNO-Maxis)

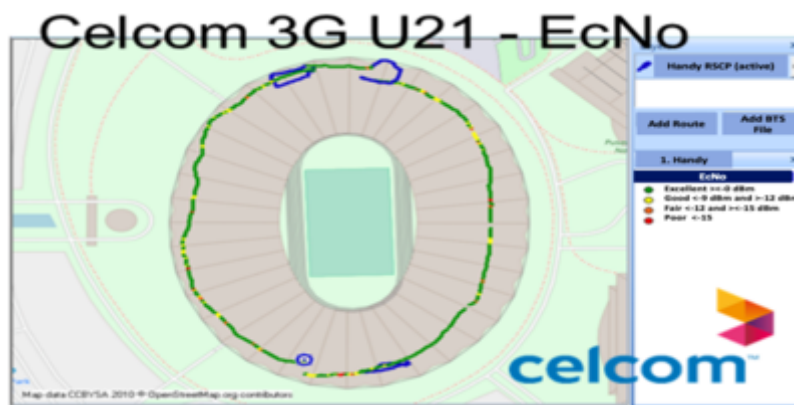

Figure 17: Walk Test for EcNo of MNOs – Celcom

traffic. The number of MS users participating in the event varies depending on their service provider, resulting in congestion and service disruptions caused by insufficient capacity of MNO services. In addition to MNOs with fewer MS users, good service is provided and there is less congestion during



Figure 18: Walk Test for EcNo of MNOs – Digi

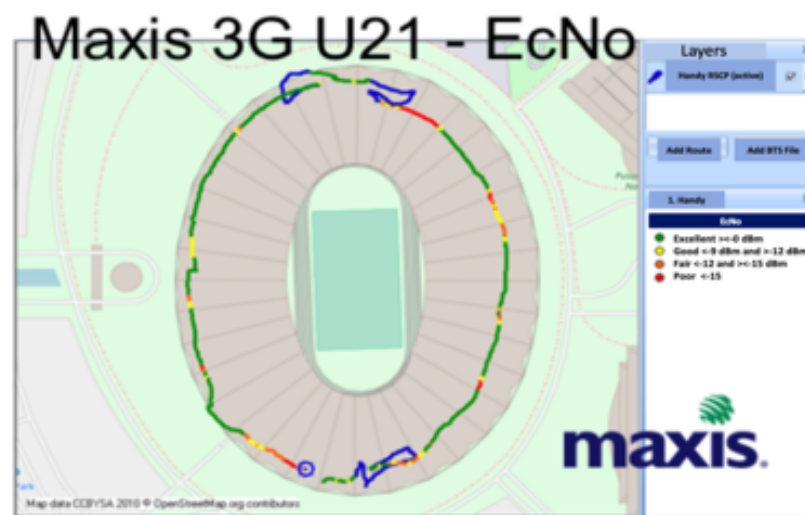

Figure 19: Walk Test for EcNo of MNOs – Maxis

the event because congestion is minimal.

Figure 21's FB proof is on display in real time at SEA GAMES 2017. The MS user uses Celcom as his service provider, and he was able to share his present with a friend in the stadium, and his colleagues received immediate response in both directions. This demonstrates that the stadium solution meets the MS user's expectations.

#### 4. Conclusion

This paper has presented the Capacity Enhancement Solution In Indoor Environment by Hybrid Combiner Circuit Of Multi Network Operator. The study of this research will concentrate on fulfilling the demand of MS users in the specific area, namely Bukit Jalil Stadium, where 2-unit RF antenna with 9-beams were deployed for the last SEA GAMES 2017 event. The highest level of Key Performance Index (KPI) is served by customers with excellent, quality service and almost any kind of service provider in any company. All spectators attending the big event in the stadium have to be aware of the demands for access to mobile networks, a finest solution is required to benefit not

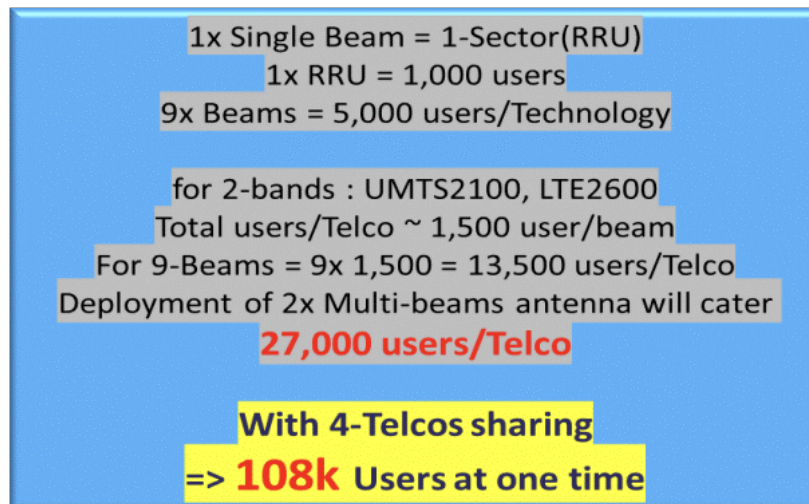

Figure 20: Dimensioning of MS users using MBA (9-beams)

Table 1: MNO traffic utilisation during Malaysia vs. Indonesia Football World Cup Qualifier at Stadium

Date (18/11/2019)	Celcom	Digi	Maxis	UMobile	Total
TIME (hours)	(Gbps)	(Gbps)	(Gbps)	(Gbps)	(Gbps)
1500hrs	0.1	0.3	0.08	0.06	0.54
1600hrs	0.2	0.4	0.11	0.08	0.79
1700hrs	0.25	0.55	0.15	0.12	1.07
1800hrs	0.4	0.8	0.25	0.14	1.59
1900hrs	0.55	1.1	0.35	0.14	2.14
2000hrs	0.65	1.25	0.39	0.14	2.43
2100hrs	0.58	1.2	0.39	0.16	2.33
2200hrs	0.58	1.2	0.38	0.178	2.338
2300hrs	0.55	1.18	0.35	0.16	2.24
2400hrs	0.35	0.8	0.24	0.14	1.53
	(MEDIAN EMD)4.21	8.78	2.69	1.318	16.998

just MS users but also mobile networking operators (MNOs). The implementation of the proposed solution, MS users will be able to access the network and will also enjoy live feeds via Facebook (FB) and other software applications without delay and interruption as well as voice call congestion.

### Acknowledgement

The authors would like to acknowledge the Research Management (RMC) UiTM Shah Alam, Selangor, Malaysia for the financial support of this research. This research is supported by RMC under project code: 600-RMC/MYRA 5/3/LESTARI (097/2020).

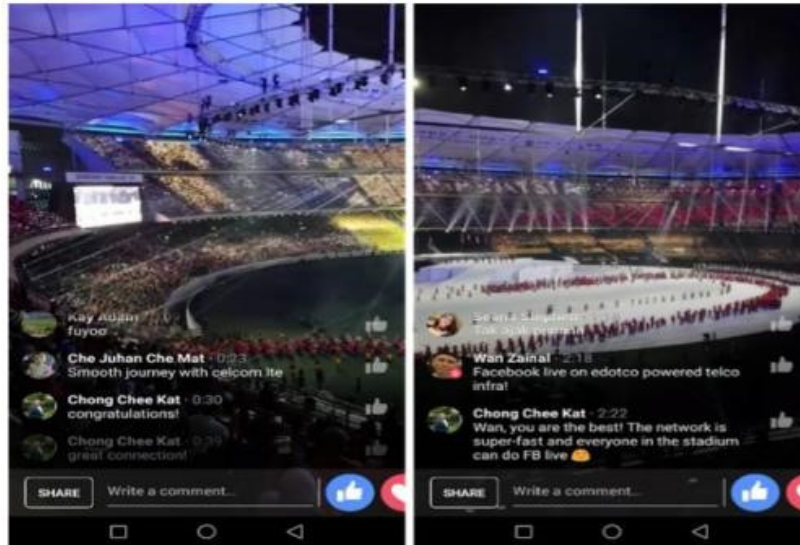

Figure 21: Facebook Live Update during Opening Ceremony of SEA GAME

## References

- [1] U. T. Blog, *TmoNews Superbowl mobile traffic : T-Mobile network proves fastest in Phoenix Stadium*, (2020) 1–16.
- [2] A. Bousia et al., *Game Theoretic Infrastructure Sharing in Multi-Operator Cellular Networks*, (2015) 1–15.
- [3] Broadradio, *Product Data Sheet Broadradio - 9LPX2006F6 9X*, (2017) 2690.
- [4] F. Callan, R. Duggal, S. Sahoo, and R. U. S. A. Data, ( 12 ) *United States Patent*, 2 (12) (2016).
- [5] A. Cassola and U. S. F. De Quito, *Authenticating Privately over Public Wi-Fi Hotspots*, 2015.
- [6] M. C. Commission and Multimedia, *Standard Radio System Plan: Requirements for international mobile telecommunications systems operating in the frequency band 2500 MHz to 2690 MHz*, 2012.
- [7] S. K. dan M. Malaysia and M. C. and M. Commission, *Requiremenets for Mobile Cellular Systems and International Mobile Telecommunication (IMT) Systems Operating in the Frequency Band 1710 MHz to 1785 MHz and 1805 MHz to 1880 MHz*, Skmm Srsp-508, (2013) 1–24, 2013.
- [8] A. Granberg, ( 12 ) *United States Patent ( 10 ) Patent No*, 2 (12) (2017).
- [9] J. Gubbi, R. Buyya, and S. Marusic, *Internet of Things ( IoT ): A Vision , Architectural Elements , and Future Directions*, (1) (2015) 1–19.
- [10] N. Intelligence, *Super Bowl LII set football and Wi-Fi network records A record amount of data was transmitted over the Wi-Fi network at Super Bowl LII , showing there is no excuse for poor Wi-Fi today . Wi-Fi usage exploded at Super Bowl LII High-quality Wi-Fi critical to digital success*, 2018.
- [11] M. T. Iqbal, *Calculation of Overlapping Area for Cellular Systems* , (2017) 2013.
- [12] P. Lau and P. Lau, *CommScope Definitions : What Is a Small Cell ? About the Author*, (2020) 1–3.
- [13] N. Lu et al., *Wi-Fi Hotspot at Signalized Intersection : Cost-Effectiveness for Vehicular Internet Access*, 9545 (c) (2015) 1–13.
- [14] R. Malhotra, A. Singla, and M. Tech, *Femto Cell : History , Technical Issues and Challenges* (2016) 2710–2717.
- [15] M. C. MCMC, *Requirements for International Mobile Telecommunication Systems*, 2018.
- [16] E. Mucelli et al., *Measurement-driven mobile data traffic modelling in a large metropolitan area To cite this version : HAL Id : hal-01089434 Measurement- driven Mobile Data Traffic Modelling in a Large Metropolitan Area*, 2015.
- [17] S. S. Sarnin, M. Y. Yusoff, and M. Y. Mohamad, *Multibeam RF Antenna Performance for Indoor Coverage in Stadium*, 11 (1)(2018) 203–208.
- [18] S. Sciences, *Data Transfer Rates and Data Traffic*, 17 (2019) 26–39.
- [19] N. Spikes and F. Engagement, *Wi-Fi Usage Surges at Super Bowl LIV For Seventh Year in a Row*, 837 (2020).
- [20] Spectrummonitoring.com, *List of Mobile Frequencies by Country (GSM, CDMA, UMTS, LTE, 5G)*, 2019.
- [21] D. Update, *About 1.23 million Maxis Mobile Subscriptions are not Profitable as of 3Q19*, (2020)2019-2021.
- [22] N. C. Us, ( 12 ) *United States Patent ( 10 ) Patent No .:*, 2 (12) (2016).