



## Journal of Advanced Research in Fluid Mechanics and Thermal Sciences

Journal homepage:

[https://semarakilmu.com.my/journals/index.php/fluid\\_mechanics\\_thermal\\_sciences/index](https://semarakilmu.com.my/journals/index.php/fluid_mechanics_thermal_sciences/index)

ISSN: 2289-7879



# Identification of ARX Model for Thermoelectric Cooling on Glass Windows

Mohd Saifizi Saidon<sup>1,\*</sup>, Nasrul Amri Mohd Amin<sup>2</sup>, 'Aqilah Che Sulaiman<sup>1</sup>, Mohd Rizal Manan<sup>1</sup>, Siti Marhainis Othman<sup>1</sup>, Wan Azani Mustafa<sup>1</sup>, Faiz Arith<sup>3</sup>

<sup>1</sup> Faculty of Electrical Engineering Technology, Universiti Malaysia Perlis, Pauh Putra Campus, 02600 Arau, Perlis, Malaysia

<sup>2</sup> Faculty of Mechanical Engineering Technology, Universiti Malaysia Perlis, Pauh Putra Campus, 02600 Arau, Perlis, Malaysia

<sup>3</sup> Faculty of Electronic and Computer Engineering, Universiti Teknikal Malaysia, Melaka, Hang Tuah Jaya 76100, Melaka, Malaysia

### ARTICLE INFO

#### Article history:

Received 10 March 2022

Received in revised form 25 May 2022

Accepted 27 May 2022

Available online 20 June 2022

#### Keywords:

Thermoelectric; ARX; glass windows; cooling; modelling

### ABSTRACT

Thermoelectric cooling (TEC) is a solid-state heat pump that uses the Peltier effect to dissipate the heat generated by the electronic packaging system. TECs are widely used in aerospace, military, scientific work and industry due to small size, lack of moving parts, and ease of integration. In this study, a cooling system integrated with TEC is developed in a testing area (lecturer's office) with the aim to reduce the temperature of the hot glass window area due to solar radiation that passes through it. This cooling system used direct TEC, for keeping the cooling temperature on the window to about 26 °C which is equivalent to an air conditioning setting temperature of 26 °C set during the experiment. This work includes experimental and modelling studies conducted on cooling systems integrated with TEC. The main target of this study is to develop a dynamic model of a cooling system integrated with TEC. The black box modelling approach in producing a mathematical model was selected based on the ARX model that corresponds to the actual dynamic state of the cooling system. The best model was finalized based on the best match on curve patterns when comparing the real and estimated models using the system identification tools in MATLAB, and also had the least error. The accuracy of the models was compared and analysed. The results showed that the 4th order of the ARX model produced a higher best fitting and standard deviation values of 78.14% and 0.030769. This system accuracy is almost within the acceptable range for most error calculations in the validation method. In addition, the ARX model is found incapable of achieving the highest fitting due to the losses from the dynamic environment and losses from the TEC itself. Still, the use of this black box model used in this study is a significant variation where system parameters can be identified even offline.

## 1. Introduction

The indoor comfort temperature is significantly influenced by the changes in climate condition that contributes to global warming. This phenomenon has increased the indoor temperature in a building with two major factors, high daily air temperature and high solar radiation energy [1-3]. Ali *et al.*, [4] reported that air-conditioning (34%), lighting (18%) and PC/laptops (10%) are the main appliances that contributed to the total energy consumption for the building in Universiti Malaya.

\* Corresponding author.

E-mail address: [satifizi@unimap.edu.my](mailto:satifizi@unimap.edu.my)

<https://doi.org/10.37934/arfmts.96.2.144157>

Due to that, the air conditioning system has been used as a mechanical system necessary to achieve indoor comfort temperature in the buildings [5].

Although many studies focused on the traditional solution where the solar gain involves the orientation of the glazing and the installation of devices, there are still shortcomings that should be considered depending on the building. Numerous analysis has concentrated on the relationship between window-wall percentage and building power utilization. Besides, smart window technology has also been studied [6-9]. Jiang *et al.*, [10] proposed the utilization of sustainable glazed water film, SGWF and found that the indoor comfort temperature was improved on a sunny day. It is due to the reduction of solar radiation that passes through the glazed window. Nonetheless, water films with endothermic glass are expensive and must have a good performance to reduce heat rise.

A thermoelectric device has been considered to be successfully commercialized due to its high reliability, low weight and less maintenance [11-13]. Thermoelectric offers two primary applications: renewable energy utilization, and generating electricity with waste energy during the heating or cooling process. This module can operate as a cooler or electricity generator [14-16]. Cooler mode allows the module to transform the current flow to direct current to the temperature gradient. Meanwhile, the electricity generator mode allows the module to produce electricity caused by the temperature gradient [17,18].

This study focuses on the investigation and development of a mathematical model for a cooling system integrated with TEC. The experimental work was performed by measuring the temperature at the glass window surface of an air-conditioned room with a volumetric space of 3 m × 4 m × 2 m. The experimental works were conducted at the Faculty of Electrical Engineering Technology, Universiti Malaysia Perlis, Perlis, Malaysia. The room was cooled using a conventional unit of 1 hp AC unit (Acson model-Non inverter) at 26 °C setting temperature. The temperature was set by referring to the suggested indoor temperature range of 23.9 °C to 26.8 °C while Zaki *et al.*, [22] specified 25.6 °C as an acceptable comfort indoor temperature in Malaysia [19-22].

## 2. Methodology

The experimental work covers the step response and PRBS input design from a cooling system integrated with TEC in a glass window. A black box model involving input/output data was used to model the cooling system from the trial-and-error method. This is done by simulating the input/output data using ARX models with the operating temperature of TEC is 26°C. The black box model is one type of system identification where the parameters of these models do not reflect the physical characteristics of the system. The whole system is linked to a computer via Arduino MEGA for collecting temperature reading purposes. The computer, TECs, microcontroller, and all the necessary hardware and instrumentation involved are discussed. It is also to analyze the parameter in designing the PRBS input. Yet, if the input and output data is not desirable, the flow needs to be repeated. Subsequently, the input and output data from the PRBS experiment is utilizing to simulate the model based on ARX model for 1<sup>st</sup>, 2<sup>nd</sup>, 3<sup>rd</sup> and 4<sup>th</sup> order.

### 2.1 Experimental Setup of Glass Window Cooling System Integrated with TEC

The schematic diagram of the TEC system is shown in Figure 1. This study used three unit of TEC powered by the power supply together with the metal oxide semiconductor field-effect transistor (MOSFET) board in order to control the duty cycle from the power supply using the Arduino interface from MATLAB through computer. The usage of three TEC units is to test the effect of the cooling system model integrated with TEC in different locations of the glass window. In addition, the

resistance temperature detector (RTD) sensor is also connected to Arduino as an interface from MATLAB to collect all the temperature data during the experiment.

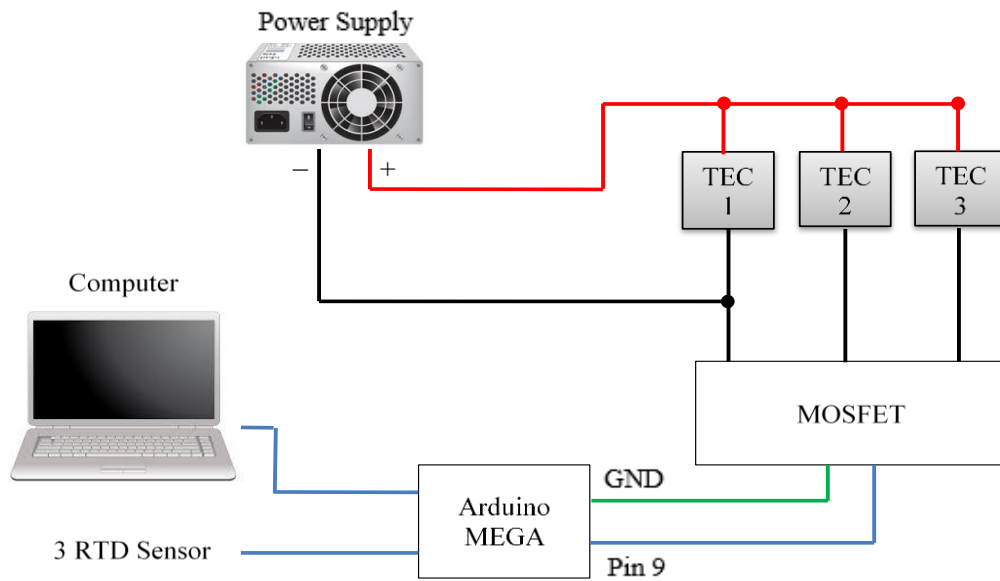

**Fig. 1.** The schematic electronic diagram of the cooling system integrated with TEC

Figure 2 shows the actual connection of MOSFET board and RTD sensor to the Arduino as an interface with MATLAB. All the connections of the electronic instrument need to be set up carefully to ensure that the wire connection is not problematic or damaged during the experiment.

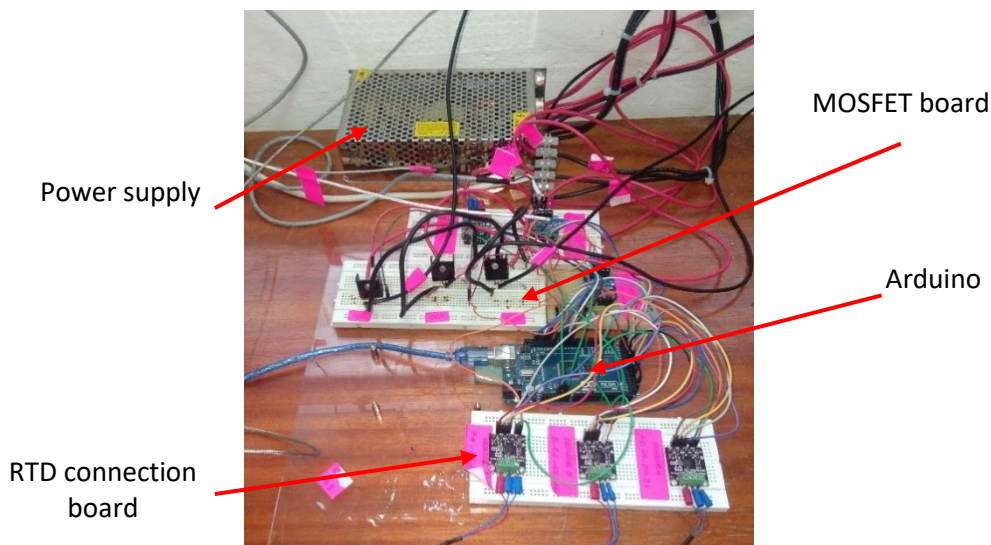

**Fig. 2.** Configuration of experimental setup for data collection and temperature control of thermoelectric cooling

Figure 3 shows the experimental setup of the cooling system integrated with TEC. At the beginning of the experiment setup, all three TECs were attached to the glass window outside the air-conditioned room. The TEC was powered up by the 12 V of power supply and the MOSFET whereby the MOSFET function is to control and monitor the duty cycle used for the TEC from the power supply using the Arduino interface from the MATLAB. In addition, the RTD sensor has been placed in the interior of the room near the mirror at a certain distance to record temperature changes in the mirror part of the air-conditioned room. For the temperature measurement, the RTD sensor was also

connected to Arduino, and the analog input data were processed and collected in the control processing unit.

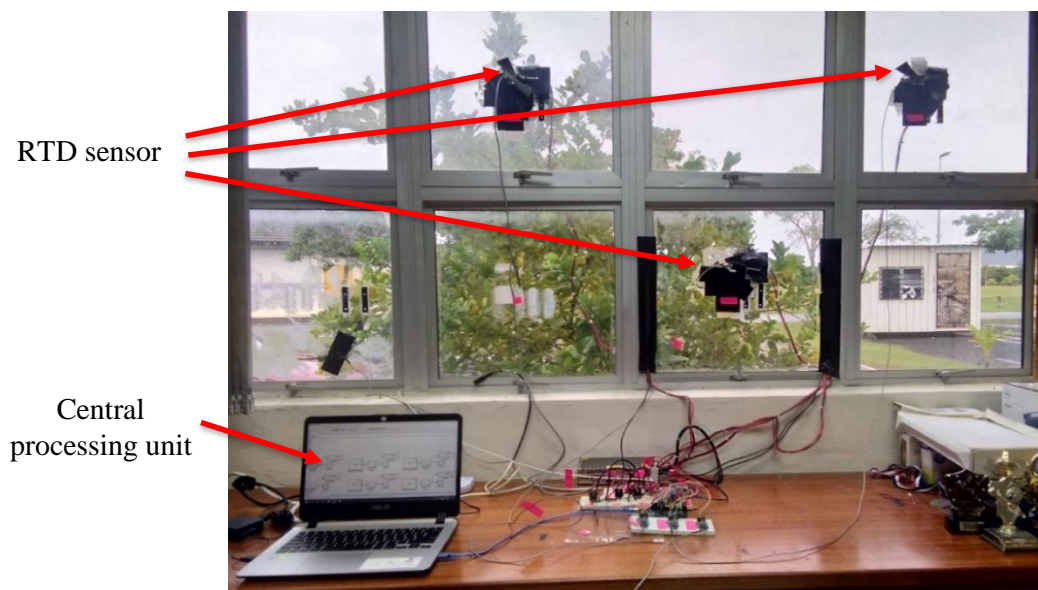

**Fig. 3.** Installation of three TEC on glass windows for cooling process and data collection

## 2.2 Data Measurement and Collection

The data of cooling system integrated with TEC begin by conducting the step response and PRBS signal experiment. For the duty cycle measurement, the TEC and MOSFET were connected to the power supply together with the RTD that used to measure the temperature of TEC. Then the Arduino Mega microcontroller board were used the analog input data as an interface to MATLAB were proceed and the data collected in the computer.

### 2.2.1 Step response experiment of thermoelectric cooling

During the step response experiment, there are different input of duty cycle were tested which is 50%, 70% and 100%. The purpose of the different usage of duty cycle is to obtain which duty cycle can produce the temperature within the operating point of 26 °C in the cooling system. The duty cycle was setup as an input in the MATLAB software and the output of the system is TEC temperature. All the temperature measurements of TEC were collected using the Arduino interface to MATLAB Simulink. The data of the temperature and duty cycle were recorded and save in the MATLAB workspace.

### 2.2.2 PRBS experiment of thermoelectric cooling

PRBS signals initiated with the highest sequence to the cooling systems as inputs signal to classify types of cooling models. It will initiate as a signal input to the cooling systems that has been integrated with MATLAB. If the real-time analysis application is applied in the system, the PRBS signal length and magnitude are significant to be selected. It will make sure that the cooling system will be stable or unstable. If the signal input and the magnitude are too small, the cooling system will not capable of functioning accurately and the system response also will not present correctly.

Besides, the cooling system will face instability styles and also face non-linear performance if the signal length and magnitude are too long. The PRBS signal is created by using the step response data. PRBS signal is time in a periodic sequence, a regulate signal and also can switch between two fixed points only in discrete intervals of time as known as bit interval,  $\Delta t$ .  $\Delta t$  is known as clock period for the PRBS signal,  $t = 0, \Delta t, (n)\Delta t, (n + 1)\Delta t$  where  $n = 1, 2, 3, 4$ . Eq. (1) is used to calculate the length of the signal, the magnitude and the clock period where  $T_c$  is the time constant of the system.

$$\Delta t = (0.2 \text{ to } 0.5) \times T_c \quad (1)$$

Since the system response has a time delay so the time period in PRBS become

$$\Delta t = (0.2 \text{ to } 0.5) \times T_c + \text{time delay} \quad (2)$$

In order to determine the accurate PRBS sequence of length ( $n$ ), the total time period of the signal in complete the steady-state in the plant dynamic model should be considered as shown in Eq. (3). The total duration time of the cooling system from the initial condition  $32^\circ\text{C}$  until the temperature of the system decreasing between the range of  $25^\circ\text{C}$  to  $26^\circ\text{C}$  is investigated. The settling time  $T_s$  of the cooling system reaches to the sequence period  $T$  of PRBS signal which the minimum length of the PRBS sequence is calculated as the following equation

$$T = \Delta t \times N \approx T_s \quad (3)$$

where  $T_s$  is settling time and the sequence length of the PRBS input signal is  $N$ . The highest length of PRBS sequence,  $n$ , is the number of shift register determined by Eq. (4)

$$N = 2^n - 1 \quad (4)$$

Every  $2^n - 1$ -bit interval, the input signal sequence repeats for a  $n$ -bit shift register. The highest length of the PRBS sequence is used as an input signal in the cooling system.

The output data from the step response experiment were used as an input design to the PRBS. After that, the PRBS experiment was conducted to gain the input and output data in real time of cooling system integrated with TEC. Based on that, the temperature within the operating point of  $26^\circ\text{C}$  is selected as input-output of ARX model.

### 2.3 Identification of ARX Model of Cooling System Integrated with TEC

In this study, the system is considered to model of a linear dynamic cooling system integrated with TEC. A perfect model representation of a particular system cannot be achieved. Yet, a useful and good mathematical model that best approach the dynamic response of the cooling system for its purpose should be obtained. The model of ARX is considered in this study to investigate the accuracy of model parameters. This model also provides an opportunity for this research to delve deeper into simulation studies especially at the modelling level. This level is very useful because the selection of model parameters for the development of an adaptive controller will be easier and more reliable.

The first flow is by selecting and defining a ARX model structure. For the parameter estimation, it is to define the best fitting percentage between real model and simulated model. The next flow, the model validation was compared for the less error between the real data and estimated data using

SSE, MSE, RMSE and standard deviation. Therefore, the selected of correct model structure used to represent the best model of the cooling system integrated with TEC at the glass window.

Input and output data collected from the tested cooling system integrated with TEC are used in the least square computer programs to verify the model and estimate the unknown parameters. In this work, ARX is tested first where the parameter of the model structure is  $n_a$  and  $n_b$ . This trial and error test from 1<sup>st</sup> up to the 4<sup>th</sup> order as shown in Table 1.

**Table 1**  
 The structure of ARX model

System order	$n_a$	$n_b$
1 <sup>st</sup> Order	1	1
2 <sup>nd</sup> Order	2	2
3 <sup>rd</sup> Order	3	3
4 <sup>th</sup> Order	4	4

The polynomial order is used to analyse ARX models is shown in Table 2. The ARX model was developed using a linear differential equation where the  $n_c$  known as noise properties are not involved as in the following Eq. (5) [23,24]. Table 2 shows the parameter structure that represent the ARX model.

$$y(t) + a_1y(t - 1) + \dots a_{na}y(t - n_a) = b_1u(t - 1) + \dots + b_{nb}u(t - nb) + e(t) \quad (5)$$

The ARX model structure is then can be expressed as Eq. (6) and Eq. (7) can also be rearranged as Eq. (8)

$$A(q^{-1}) = 1 + a_1q^{-1} + \dots a_{na}q^{-na} \quad (6)$$

$$B(q^{-1}) = b_1q^{-1} + \dots b_{nb}q^{-nb} \quad (7)$$

$$y(t) = \frac{B(q^{-1})}{A(q^{-1})}u(t) + \frac{1}{A(q^{-1})}e(t) \quad (8)$$

**Table 2**  
 The parameter structure of ARX model

Model structure ( $n_a, n_b$ )	Parameter structure
(1,1)	$n = [a_1 \ b_1]$
(2,2)	$n = [a_1 a_2, \ b_1 b_2]$
(3,3)	$n = [a_1 a_2 a_3, \ b_1 b_2 b_3]$
(4,4)	$n = [a_1 a_2 a_3 a_4, \ b_1 b_2 b_3 b_4]$

### 3. Results

The black box modelling is analysed in this study. Starting from step response analysis, which studied the effect of transient when the input signal is injected into the system. The step response analysis was then used to design the PRBS input signal to implement the analysis from the cooling system integrated with the TEC model.

The experimental work was done by trial and error method with a minimum duty cycle of 50%, 70% and a maximum duty cycle of 100%. Table 3 shows that when the duty cycle is 50%, the system becomes stable at 30.2 °C, during 70% of the duty cycle the temperature is steady at 27.8 °C. After

that, the system produces the temperature within the operating point of 26 °C in the cooling system when the duty cycle is 100% and becomes steady at a range of 25.5 °C.

**Table 3**

Duty cycle behaviour of the cooling system	
Duty Cycle (%)	Steady state (°C)
50	30.2
70	27.8
100	25.5

### 3.1 Step Response Analysis

The main purpose of this section is to discuss the dynamic behaviour of the cooling system integrated with TEC under the influence of heat radiation at the window area. The step response analysed is about the transient effect of three TEC devices of the cooling system after the chosen input signal is applied.

The modelling was designed to perform the input signal of PRBS from the step response. The transient effect of the system then produces the open loop system that varied with time in the operating system. The experimental work was done by trial and error method with a minimum duty cycle of 50%, 70% and the maximum duty cycle is 100%. Figure 4 shows that when 70% duty cycle is injected into the system, the temperature of the cooling system is steady between 27.8 °C and 27.4 °C. At 2000 s, the step-up is given to increase the duty cycle up to 100%. Because of that, the TEC temperature decreases drastically. After 4000s, the temperature sustains around 25.4 °C to 25.6 °C. Based on the result from the experimental work, the system performance with 100% of duty cycle was chosen for PRBS signal design due to the reach of the desired temperature of 26 °C.

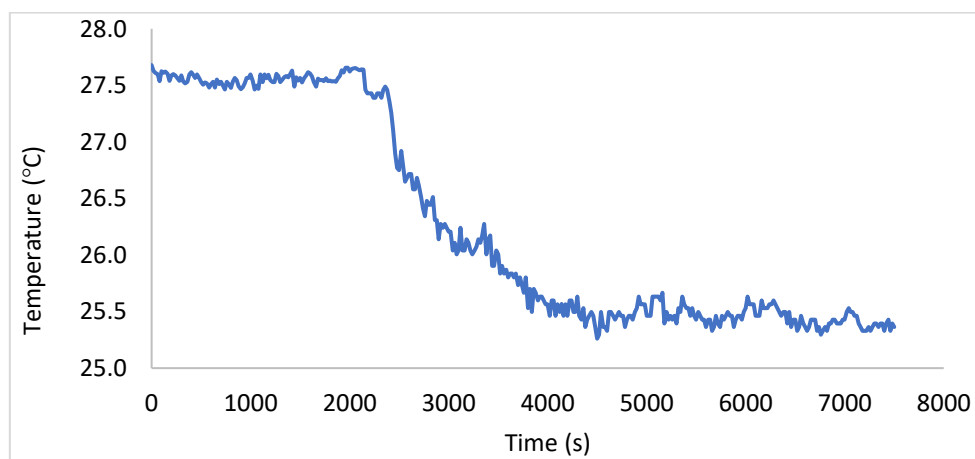

**Fig. 4.** Step response at 70% to 100% duty cycle of the system

Figure 5 shows the response of the cooling system, indicating that the system has a slow settling time of transient response with time delay performance. Nonetheless, the system did not provide any overshoot performance. Henceforth, the effect of the system was analysed towards the experiment data is then recorded at 20 s of the acquisition period.

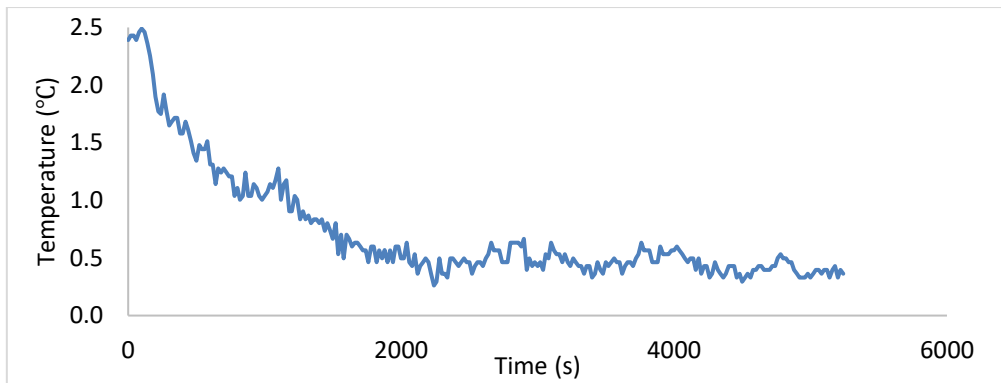

**Fig. 5.** Step input signal applied to the system

Table 4 shows the step response performance of the system recorded with the approximation value of the cooling system integrated with TEC in time constant and settling time when the duty cycle is set as 100%. The temperature of the cooling system started to change at 200 s, and at 2000 s an oscillation is found to occur between 25 °C to 26 °C. Consequently, it can be used as an input to design the PRBS.

**Table 4**  
 Duty cycle 100% response of TEC cooling

Duty Cycle	100%
Time Constant (s), $T_c$	220
Settling Time (s), $T_s$	2000

To summarize, the temperature of TEC gets the desired temperature of 26 °C for the cooling system when the maximum duty cycle injects into the system. Still, the system shows a slow settling time of transient response with time delay performance. The data is collected from the TEC temperature at the window area in the air-conditioned room with the air conditioning temperature setting 26 °C. Due to the variation of the duty cycle, the step response also showed different transient conditions, but there are slight differences among the duty cycle result.

### 3.2 Input-Output Data from PRBS

Data collection was done by conducting experiments according to the selected step response design. The length and magnitude of the PRBS sequence are required and should be carefully selected, especially in the real-time parameter estimates. The signals of PRBS are adequately selected as they affected the temperature of the system. Yet, the sequence length does not produce significant changes to the output of the cooling system where the temperature does not differ at 25 °C.

Figure 6 shows the PRBS analysis result where the PRBS input signal is chosen from 70% to 100% of duty cycle, and the input switched up and down with 60 data samples tested and 20 s of sampling time. Meanwhile, the output signal is sustained within the desired temperature 26 °C. The results showed that the TEC temperature response varied from 25 °C to 26 °C in a system.

The collected data in Figure 6 is used in dynamic modelling of the cooling system integrated with TEC in the simulation work. The nature of TEC devices usually is nonlinear; therefore, the optimum selection of the operating point for the cooling system in given application requires an iterative process. Based on this subchapter, the operating point of the system application is full input current utilizing to archive the desired temperature range of the TEC.



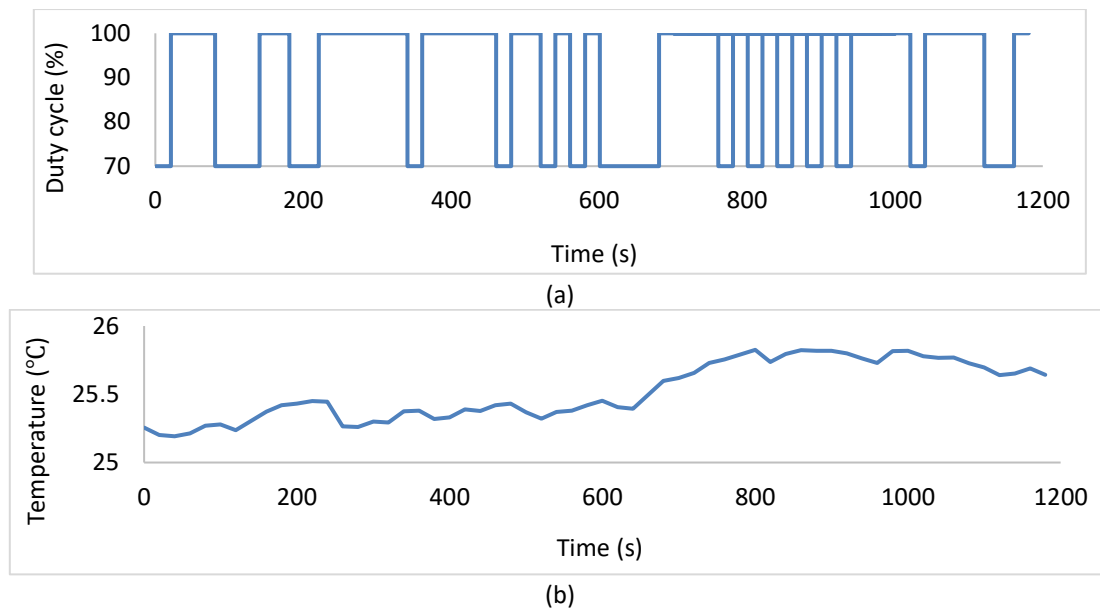

**Fig. 6.** The temperature response measured in the cooling system integrated with TEC with (a) PRBS input signal of MOSFET, and (b) The output temperature of the system

### 3.3 Parameter Estimation of ARX Model

The ARX model designed can estimate with the system model order up to 4<sup>th</sup> order. The estimated value of the system is poor at the beginning of the identification process due to inaccurate parameter values, but once the parameter is estimated correctly, the error of modelling is minimized. Nevertheless, the lowest error among all orders is at the 4<sup>th</sup> order with model structure (4,4) when the best fitting is 78.14%. By referring to Table 8, the error analysis for 4<sup>th</sup> resulted to SSE = 0.124817, MSE = 0.002080, RMSE = 0.045610 and standard deviation of 0.030769. According to Table 6, Table 7 and Table 8, the model structure of (2,2) of 2<sup>nd</sup> order, (3,3) of 3<sup>rd</sup> order and (4,4) of 4<sup>th</sup> order of ARX model shows the lowest error values.

In order to distinguish between the 1<sup>st</sup>, 2<sup>nd</sup>, 3<sup>rd</sup>, and 4<sup>th</sup> orders, a comparison was made and the 4<sup>th</sup> order of (4,4) was found to have the lowest error value. It also indicates that the 4<sup>th</sup> order of ARX model structure of (4,4) has the better fit to the real time of cooling system when compared to the 3<sup>rd</sup> and 4<sup>th</sup> order.

**Table 5**  
 The error analysis of 1<sup>st</sup> order of ARX model

Model structure ( $n_a, n_b$ )	Best fit (%)	SSE	MSE	RMSE	Standard deviation
(1,1)	76.40	0.145401	0.002423	0.049228	0.032396

**Table 6**  
 The error analysis of 2<sup>nd</sup> order of ARX model

Model structure ( $n_a, n_b$ )	Best fit (%)	SSE	MSE	RMSE	Standard deviation
(2,2)	76.87	0.139705	0.002328	0.048254	0.032339
(2,1)	77	0.138108	0.002302	0.047977	0.031834

**Table 7**  
 The error analysis of 3<sup>rd</sup> order of ARX model

Model structure (n <sub>a</sub> , n <sub>b</sub> )	Best fit (%)	SSE	MSE	RMSE	Standard deviation
(3,1)	77.63	0.130721	0.002179	0.046676	0.030801
(3,2)	77.76	0.129154	0.002153	0.046396	0.030348
(3,3)	77.85	0.128143	0.002136	0.046214	0.030283

**Table 8**  
 The error analysis of 4<sup>th</sup> order of ARX model

Model structure (n <sub>a</sub> , n <sub>b</sub> )	Best fit (%)	SSE	MSE	RMSE	Standard deviation
(4,1)	78	0.126399	0.002107	0.045898	0.031054
(4,2)	78.05	0.125783	0.002096	0.045786	0.030626
(4,3)	78.14	0.125838	0.002081	0.045614	0.030805
(4,4)	78.14	0.124817	0.002080	0.045610	0.030769

It is worth mentioning here, that test with ARX model, has an absence of noise that may result in the smallest error value depicted. For these cases, the ARX model are closed to the real time model of the cooling system integrated with TEC. Table 9 summarizes the parameter value for the 2<sup>nd</sup>, 3<sup>rd</sup> and 4<sup>th</sup> order models for the highest best fitting of ARX model.

**Table 9**  
 ARX model parameter value

Model structure (n <sub>a</sub> , n <sub>b</sub> )	a1	a2	a3	a4	b1	b2	b3	b4
(2,2)	-1.11803	0.12086			0.00016	0.00020		
(3,3)	-1.14566	0.41362	-0.26296		0.00025	0.00021	0.00016	
(4,4)	-1.18561	0.48135	-0.45036	0.15954	0.00028	0.00014	0.00016	0.00003

Based on the above observations, Figure 7 to Figure 9 show the estimated model of 2<sup>nd</sup>, 3<sup>rd</sup> and 4<sup>th</sup> order of ARX with model structures (2,2), (3,3) and (4,4) are plotted against the real models. It clearly shows that the real model and the estimated model output of all orders are in good agreement during the model validation. Yet, the 4<sup>th</sup> order of ARX structure (4,4) shows the better fit which is 78.14%.

To ensure that the 4<sup>th</sup> order structure model can fully represent the system, it is important to validate the process with system stability to ensure the right choice has been made. In is due to the fact that the poles have a direct consequence the dynamic properties of the stability of the system. This is an important observation for the properties of the system by carefully monitoring the poles and zeros of the system. Figure 10 shows the pole-zero diagram for the 4<sup>th</sup> order of ARX model. All poles and zeros are explicitly located within the circumference of the unit circle indicating a stable condition.

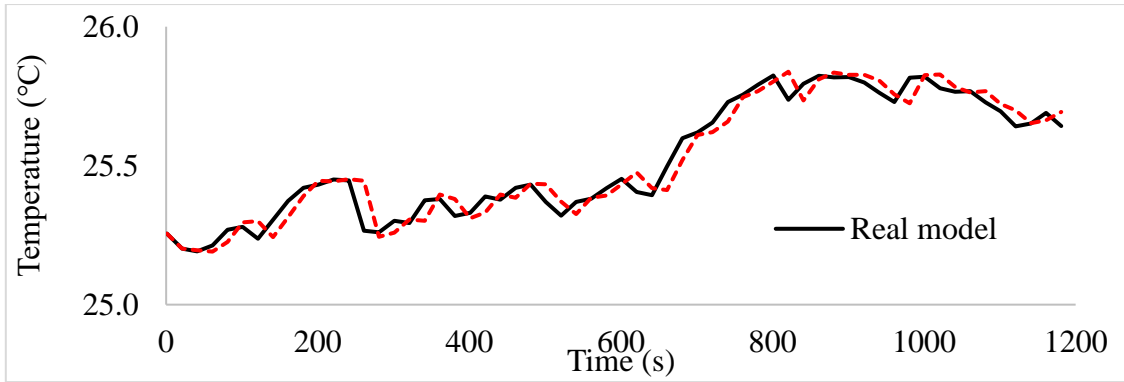

**Fig. 7.** The 2<sup>nd</sup> order of ARX model structure (2,2) with best fitting is 77%

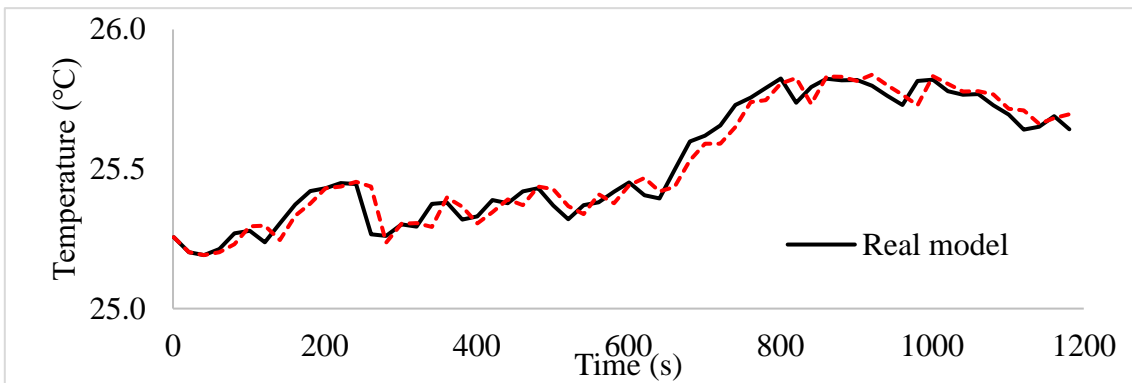

**Fig. 8.** The 3<sup>rd</sup> order of ARX model structure (3,3) and best fitting is 77.85%

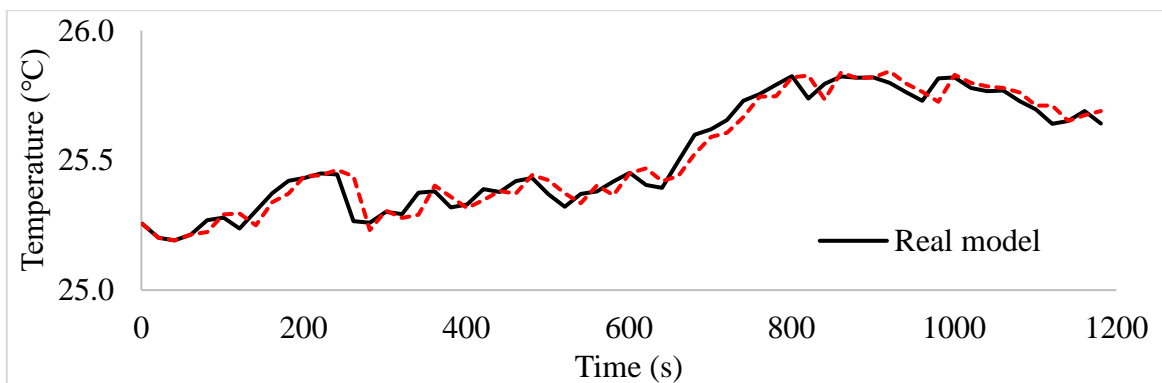

**Fig. 9.** The 4<sup>th</sup> order of ARX model structure (4,4) with 78.14% of best fitting

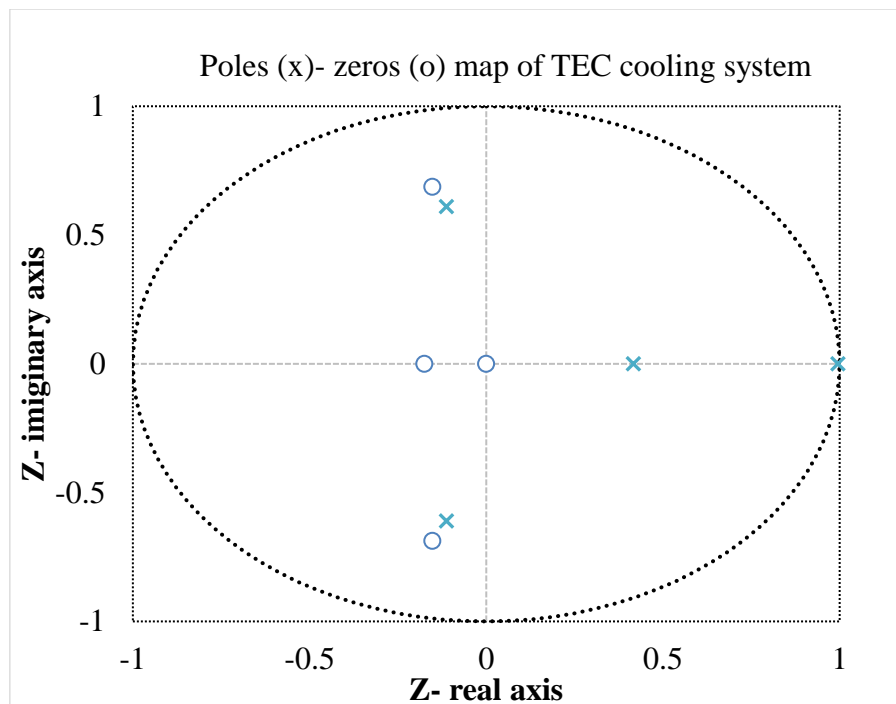

Fig. 10. The pole-zero diagram for the 4<sup>th</sup> order of ARX model model structure (4,4)

#### 4. Conclusions

This study is on dynamic identification of the performance of a cooling system integrated with TEC. This is an attempt to address the potential techniques and tools in identification to meet immediate modelling for future control needs. The utilizing of TEC in this work is to investigate the performance of TEC to reach the required temperature. A comprehensive experimental investigation was developed for data acquisition with regulated of the desired temperature at 26 °C. The system demonstrated experimentally with three TECs.

The dynamic identification procedure was developed to ensure the best model fit the cooling system integrated with thermoelectric. The system needs to be represented by minimum error, representing the accuracy of the model even when variation occurs since the parameter of the actual system is changed due to the dynamic environment.

In this study, the linear identification system used is ARX model. The mathematical structure based on ARX has been estimated through the performance of the dynamical behaviour of this cooling system integrated with TEC. The model was chosen due to having the best fitting graph generated in system identification tools in MATLAB and least error between real and estimated outputs. The results indicated that the 4<sup>th</sup> order of ARX model showed the best fit of 78.14%, with a standard deviation of 0.030769.

#### Acknowledgment

This work is supported by Research Management Centre of Universiti Malaysia Perlis.

#### References

- [1] Tatarestaghi, Fahimeh, Muhammad Azzam Ismail, and Nor Haniza Ishak. "A comparative study of passive design features/elements in Malaysia and passive house criteria in the tropics." *Journal of Design and Built Environment* 18, no. 2 (2018): 15-25. <https://doi.org/10.22452/jdbe.vol18no2.2>
- [2] Yue, Wenze, Xue Liu, Yuyu Zhou, and Yong Liu. "Impacts of urban configuration on urban heat island: An empirical

- study in China mega-cities." *Science of the Total Environment* 671 (2019): 1036-1046. <https://doi.org/10.1016/j.scitotenv.2019.03.421>
- [3] Amir, Ashrifa, Mohd Farid Mohamed, M. K. A. M. Sulaiman, and Wardah Fatimah Mohammad Yusoff. "Assessment of indoor thermal condition of a low-cost single story detached house: A case study in Malaysia." *Alam Cipta* 12 (2019): 80-88.
- [4] Ali, Siti Birkha Mohd, Md Hasanuzzaman, N. A. Rahim, M. A. A. Mamun, and Unaizah Hanum Obaidallah. "Analysis of energy consumption and potential energy savings of an institutional building in Malaysia." *Alexandria Engineering Journal* 60, no. 1 (2021): 805-820. <https://doi.org/10.1016/j.aej.2020.10.010>
- [5] Tuck, Ng Wai, Sheikh Ahmad Zaki, Aya Hagishima, Hom Bahadur Rijal, and Fitri Yakub. "Affordable retrofitting methods to achieve thermal comfort for a terrace house in Malaysia with a hot-humid climate." *Energy and Buildings* 223 (2020): 110072. <https://doi.org/10.1016/j.enbuild.2020.110072>
- [6] Chu, Steven, Yi Cui, and Nian Liu. "The path towards sustainable energy." *Nature Materials* 16, no. 1 (2017): 16-22. <https://doi.org/10.1038/nmat4834>
- [7] Sabry, M., P. C. Eames, H. Singh, and Yupeng Wu. "Smart windows: Thermal modelling and evaluation." *Solar Energy* 103 (2014): 200-209. <https://doi.org/10.1016/j.solener.2014.02.016>
- [8] Feng, Wei, Liping Zou, Guohua Gao, Guangming Wu, Jun Shen, and Wen Li. "Gasochromic smart window: optical and thermal properties, energy simulation and feasibility analysis." *Solar Energy Materials and Solar Cells* 144 (2016): 316-323. <https://doi.org/10.1016/j.solmat.2015.09.029>
- [9] Mustafa, Wan Azani, Syahrul Affandi Saidi, Mustafa Zainal, and Ragunathan Santiagoo. "Experimental study of composites material based on thermal analysis." *Journal of Advanced Research in Fluid Mechanics and Thermal Sciences* 43, no. 1 (2018): 37-44.
- [10] Jiang, Sihang, Xianting Li, Weihua Lyu, and Shuai Yan. "Numerical analysis on the load reduction of a pipe-embedded window with different water temperatures and structures under different climates." *Science and Technology for the Built Environment* 25, no. 9 (2019): 1187-1198. <https://doi.org/10.1080/23744731.2019.1642094>
- [11] He, Ran, Gabi Schierning, and Kornelius Nielsch. "Thermoelectric devices: a review of devices, architectures, and contact optimization." *Advanced Materials Technologies* 3, no. 4 (2018): 1700256. <https://doi.org/10.1002/admt.201700256>
- [12] Xiao-Kai, Hu, Zhang Shuang-Meng, Zhao Fu, Liu Yong, and Liu Wei-Shu. "Thermoelectric device: contact interface and interface materials." *Journal of Inorganic Materials* 34, no. 3 (2019): 269. <https://doi.org/10.15541/jim20180248>
- [13] Sajid, Muhammad, Ibrahim Hassan, and Aziz Rahman. "An overview of cooling of thermoelectric devices." *Renewable and Sustainable Energy Reviews* 78 (2017): 15-22. <https://doi.org/10.1016/j.rser.2017.04.098>
- [14] Zeb, Kamran, Sahibzada M. Ali, Bilal Khan, Chaudhry A. Mehmood, N. Tareen, W. Din, U. Farid, and A. Haider. "A survey on waste heat recovery: Electric power generation and potential prospects within Pakistan." *Renewable and Sustainable Energy Reviews* 75 (2017): 1142-1155. <https://doi.org/10.1016/j.rser.2016.11.096>
- [15] Pourkiaei, Seyed Mohsen, Mohammad Hossein Ahmadi, Milad Sadeghzadeh, Soroush Moosavi, Fathollah Pourfayaz, Lingen Chen, Mohammad Arab Pour Yazdi, and Ravinder Kumar. "Thermoelectric cooler and thermoelectric generator devices: A review of present and potential applications, modeling and materials." *Energy* 186 (2019): 115849. <https://doi.org/10.1016/j.energy.2019.07.179>
- [16] Salah, Wael A., and Mai Abuhelwa. "Review of thermoelectric cooling devices recent applications." *Journal of Engineering Science and Technology* 15, no. 1 (2020): 455-476.
- [17] Kürkçü, Burak, and Coşku Kasnakoğlu. "Robust Temperature Control of a Thermoelectric Cooler via  $\mu$ -Synthesis." *Journal of Electronic Materials* 47, no. 8 (2018): 4421-4429. <https://doi.org/10.1007/s11664-018-6104-1>
- [18] Teffah, Khaled, Youtong Zhang, and Xiao-long Mou. "Modeling and experimentation of new thermoelectric cooler-thermoelectric generator module." *Energies* 11, no. 3 (2018): 576. <https://doi.org/10.3390/en11030576>
- [19] Ashrae, A. N. S. I. "Standard 55-2013: Thermal environmental conditions for human occupancy." *American Society of Heating, Refrigerating, and Air-Conditioning Engineers, Inc.* Atlanta (2013).
- [20] Ashrae, A. N. S. I. "Standard 55-2017 thermal environmental conditions for human occupancy." *American Society of Heating, Refrigerating, and Air-Conditioning Engineers, Inc.* Atlanta (2017).
- [21] Wang, Zhe, and Tianzhen Hong. "Learning occupants' indoor comfort temperature through a Bayesian inference approach for office buildings in United States." *Renewable and Sustainable Energy Reviews* 119 (2020): 109593. <https://doi.org/10.1016/j.rser.2019.109593>
- [22] Zaki, Sheikh Ahmad, Siti Aisyah Damiani, Hom Bahadur Rijal, Aya Hagishima, and Azli Abd Razak. "Adaptive thermal comfort in university classrooms in Malaysia and Japan." *Building and Environment* 122 (2017): 294-306. <https://doi.org/10.1016/j.buildenv.2017.06.016>
- [23] Tran, Ngoc-Tham, Abdul Basit Khan, and Woojin Choi. "State of charge and state of health estimation of AGM VRLA batteries by employing a dual extended kalman filter and an ARX model for online parameter estimation." *Energies*

- 10, no. 1 (2017): 137. <https://doi.org/10.3390/en10010137>
- [24] Amran, M. A. N., A. A. Bakar, M. H. A. Jalil, M. U. Wahyu, and A. F. H. A. Gani. "Simulation and modeling of two-level DC/DC boost converter using ARX, ARMAX, and OE model structures." *Indonesian Journal of Electrical Engineering and Computer Science* 18, no. 3 (2020): 1172-1179. <https://doi.org/10.11591/ijeecs.v18.i3.pp1172-1179>