

Load and Coupling Variations Analysis of Capacitive Power Transfer at 6.78MHz Operating Frequency for Biomedical Implantable Device

Muslimah Meor¹, Yusmarnita Yusop^{1*}, Shakir Saat¹, Huzaimah Husin¹, Khairul Kamarudin Hasan²

¹Centre of Telecommunication Research & Innovation (CeTRI), Fakulti Kejuruteraan Elektronik & Kejuruteraan Komputer, Universiti Teknikal Malaysia Melaka, Malaysia.

²Faculty of Electrical Engineering, Universiti Teknologi Mara, Cawangan Johor, Kampus Pasir Gudang, Johor, Malaysia.

*Corresponding author: yusmarnita@utem.edu.my

Abstract: This paper presents the design and analysis of load and coupling variations for a current Wireless Power Transfer (WPT) technique, known as Capacitive Power Transfer (CPT). Due to its strength, CPT becomes an effective and essential alternative to conservative technique, which is Inductive Power Transfer (IPT). It can compete with IPT in industrial demand since it has a small number of component usage, uncomplicated topology, increases electromagnetic interference (EMI) shielding performance and robust to surrounding metallic elements. Class E power amplifier with the presence of $\pi 1b$ matching resonant circuit is applied in this work as a high frequency ac power source since it has the ability to perform dc-to-ac inversion efficiently. It supports the CPT system to attain a maximum power transmission. MATLAB software is used to design and simulate the CPT circuit; and the analysis is made up from the results. This proposed system able to generate 1W of output power by maintaining up to 98% efficiency at 6.78MHz operating frequency for Biomedical Implantable Device application. The analysis of load variation is in the range of 50Ω until $1k\Omega$; meanwhile for coupling variation is between 1mm to 15mm.

Keywords: Biomedical Implantable Device, Capacitive Power Transfer, Class E Power Amplifier, Wireless Power Transfer, $\pi 1b$ matching resonant circuit

© 2023 Penerbit UTM Press. All rights reserved

Article History: received 1 August 2022; accepted 2 May 2023; published 28 August 2023.

1. INTRODUCTION

Nowadays, the development of Wireless Power Transfer (WPT) technology grows so fast since its market demand is increasing for wireless charging devices, applications, tools and equipment. Thus, direct metal-to-metal contact method leaves off [1-5]. Until today, Inductive Power Transfer (IPT) has fulfilled good performance and be the most popular technique for this technology; nevertheless, this technique has a few of drawbacks which can be countered by Capacitive Power Transfer (CPT). Foremost, since IPT utilize magnetic field as transfer interface, thus it is unable to penetrate through metals shielding environment. Therefore, it is irrelevant to apply in condition which metal barriers exist between the power sources and loads; indirectly, this technique is inapplicable for Biomedical Implantable Devices (BID) applications because most of the device's elements are made up of metals. In addition, due to electromagnetic field is applied as the "energy carrying medium", it may cause in electromagnetic interference (EMI). Hence, the CPT technique is introduced in order to overcome the disabilities of IPT. It used electric field as transfer interface which has the ability to penetrate through metal shielding environment [6-8]. Besides, it has good anti-interference ability of magnetic field [9-11].

Power amplifier is one of the essential elements in

transmitter part of CPT system since it regulates the complete system outcomes. Class E power amplifier is proposed for this system due to its special characteristics. It has simple topology and a good efficiency performance which has the capability to achieve 100% switching condition named Zero-Voltage Switching (ZVS) [12-14]. Therefore, this power amplifier is the most preferable for WPT system. The overlapping throughout the switching time intervals between switch current and voltage waveform must be prevented; hence, it will attain magnificent efficiency since switching losses are nearly zero besides choose the perfect value of components usage [15].

Impedance matching is defined as a technique to illustrate the source and load are effectively equal [16]. This technique is applied in order to match a load resistance to a source aims for achieving highest power transfer [16]. It is commonly added in power transfer system to increase efficiency of the system [17] and expand the ability of power transfer to the load [18-23]. By applying this process, the system will attain maximum efficiency [17, 19]. A few types of impedance matching that commonly used in WPT circuits are $\pi 1a$, $\pi 1b$, $\pi 2a$ and $\pi 2b$ matching resonant circuit.

For BID application, $\pi 1b$ matching resonant circuit is chosen for this proposed system due to its strength which is

more superior compare to other impedance matchings. It suits perfectly for the application which needed smaller size of receiver unit and smaller value of components usage which cannot be handled by other impedance matchings. This concern is due to consideration for human friendly and safety which required the smallest size of device to implant in human body. Reducing size and weight in order to produce a BID is a strong trend to make sure it is compatible with normal human activities and increase comfort for the host [24].

6.78MHz operating frequency is preferable for this proposed system. This is referring to the most current researches which WPT system and BID application safe and suit to operate at the Industrial Scientific Medical (ISM) band 6.78MHz [25-30].

The contributions of this paper can be summarized as follows:

- 1) This work highlights on CPT system based on Class E power amplifier with π 1b matching resonant circuit for BID application which powered with 12V dc input supply at 6.78MHz operating frequency in producing an idle sinusoidal signal across the loads.
- 2) This system able to generate 1W output power and maintain over 90% of power transmission efficiency in a range of load and distance.
- 3) In this work, analysis of load and coupling variations for CPT systems are shown in section III in detail.

This paper is organized as follows: Section II shows the design of CPT system, Section III presents the results and discussion and final section, Section IV is conclusion of this work.

2. CAPACITIVE POWER TRANSFER SYSTEM

Figure 1 shows the proposed system of this work known as CPT system. It consists of 2 major parts, which are transmitter part and receiver part. In between of these two major parts, they are separated by a medium which can be air gap, a paper, muscle tissue, plastic, etc. In the case of this proposed system which focuses on BID application, the 2 major parts are separated by muscle tissues which act as a human body. The transmitter part is outside the human body; meanwhile the receiver part is inside the human body. The transmitter part is inverting a high frequency voltage source which transforms the standard frequency dc power supply into a high frequency ac voltage and then transfer to transmitter coupling plates. When the transmitter coupling plates are placed close to the receiver coupling plates, the alternating electric field is formed in the between; thus, displacement current able to flow through it. Two capacitors are connected in series during this CPT operation; this shows the function of electric field coupler then resulting in power that can be transferred to the load in receiver part without direct electrical contact. The design of this system will be explained in detail in the next section.

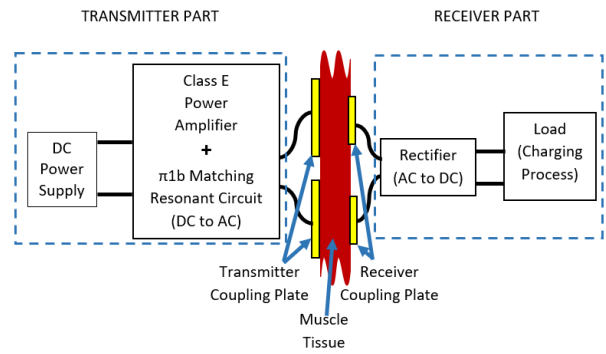

Figure 1. The illustration of CPT system

2.1 The Design of Class E

The basic circuit of Class E power amplifier is shown as in Figure 2. The operation of this circuit is left off since it is explained well in [12]. Commonly, the power amplifier is functioning in fixing the output voltage. However, the output voltage still can be adjusted by changing the duty cycle and switching frequency.

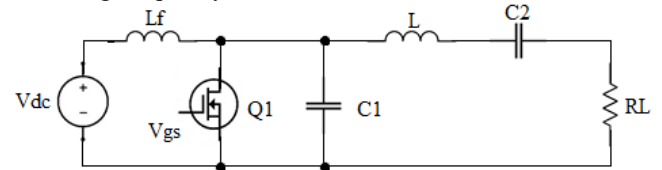

Figure 2. Class E Power Amplifier Circuit

This basic circuit has two important elements which are power MOSFET and load network. The power MOSFET is operating as a switch at input frequency; while, the load network is consisting of shunt capacitor, C_1 and a series resonant $R_L - C_2 - L$ output circuit. Besides, choke inductor, L_f is working to force the dc current, I_{dc} and it is normally high enough to force the dc current, I_{dc} .

In the case of optimum operation which duty cycle, D is 0.5, value of components in Figure 2 can be calculated as follows:

The full-load resistance can be calculated as:

$$R = R_s = \frac{8V_{dc}^2}{(\pi^2 + 4)P_o} = 0.5768 \frac{V_{dc}^2}{P_o} \quad (1)$$

Next, the reactance of shunt capacitor is then:

$$X_{C1} = \frac{1}{\omega C_1} = \frac{\pi(\pi^2 + 4)R}{8} \approx 5.4466R \quad (2)$$

The reactance of resonance inductor can be obtained:

$$X_L = \omega L = Q_L R \quad (3)$$

Last, the reactance of resonance capacitor is given by:

$$X_C = \frac{1}{\omega C} = \left[Q_L - \frac{\pi(\pi^2 - 4)}{16} \right] R \approx (Q_L - 1.1525)R \quad (4)$$

In the basic circuit of Class E power amplifier as shown in Figure 2, impedance matching does not exist. Therefore, the value of load resistance, R has to be exact as calculated from (1) in order to transfer a specified amount of output power, P_o at a specified dc voltage, V_{dc} . Nevertheless, impedance matching is formed in order to satisfy a range of desired load resistances.

2.2 $\pi 1b$ Matching Resonant Circuit

The purpose of impedance matching network is to transform the load resistance or impedance into the impedance required to produce the desired output power, P_o at the specified direct current voltage, V_{dc} and the operating frequency, f . Referring to (1), V_{dc} , P_o and R are dependent quantities. In many applications, the load resistance is stated and different from (1); thus, matching circuit is needed to provide impedance transformation either downwards or upwards.

A diagram of Class E power amplifier with matching resonant circuit $\pi 1b$ is shown in Figure 3. This impedance matching type is chosen because of the capacitor is connected in series with the load which will be then modified to capacitor coupling plate to fit the actual CPT system. The reactance of shunt capacitor, X_{C1} and reactance of resonant inductor, X_L values can be determined for optimum operation at $D=0.5$ from (2) and (3) respectively.

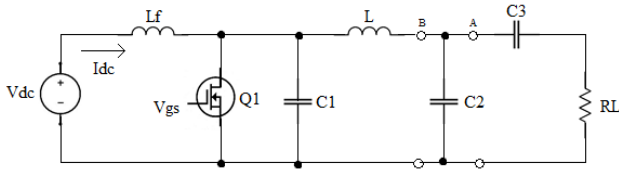

Figure 3. Class E Power Amplifier with $\pi 1b$ Matching Resonant Circuit

The components value in Figure 3 can be obtained by referring to *part A* and applying these formulas:

The design equation for the reactance of capacitor C_3 is:

$$X_{C3} = \frac{1}{\omega C_3} = q_A R_L$$

$$= R_L \sqrt{\frac{R[(Q_L - 1.1525)^2 + 1]}{R_L} - 1} \quad (5)$$

This given the design equation for the reactance X_{c2} as:

$$X_{C2} = \frac{1}{\omega C_2}$$

$$= \frac{R[(Q_L - 1.1525)^2 + 1]}{Q_L - 1.1525 - \sqrt{\frac{R[(Q_L - 1.1525)^2 + 1]}{R_L} - 1}} \quad (6)$$

3. RESULT AND DISCUSSION

The design specifications were set up as follows in order to satisfy the output requirement: Dc power supply, $V_{dc} = 12V$, operating frequency, $f = 6.78MHz$, $Q = 10$, $D = 0.5$, and output power, $P_o = 1W$. The circuit parameters are set up based on the equation as stated in section II and also from the design specifications. MATLAB/Simulink software is used to simulate the circuits in order to analyse the load and coupling variations for complete CPT system. The circuit performances can be studied and analysed for both variations. The matching resonant circuits are proposed to the system in order to achieve the satisfactory of circuit performance which able to generate 1W output power since biomedical implantable device, such as pacemaker requires only in the range of $10\mu W$ to $1mW$ output power [31] and maximizing the efficiency of power transfer over 90%. The comparison in term of receiver part size is one of the most vital purposes of matching resonant circuit.

3.1 Load Variations

Figure 4 shows the simulation circuit of load variations. The value of load resistance, R_L is changed started from 50Ω until 1000Ω . The data of the load variations is tabulated in Table 1.

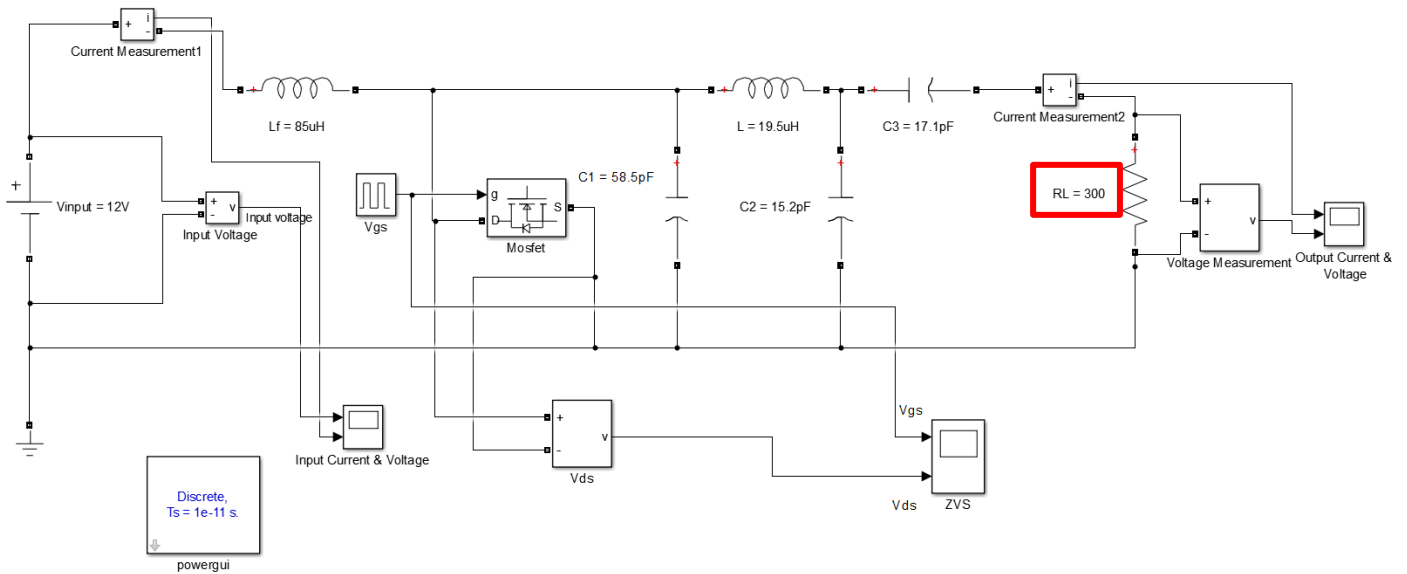

Figure 4. Class E Power Amplifier with $\pi 1b$ Matching Resonant Circuit for Load Variations

Table 1. Load variations of Capacitive Power Transfer

Load Resistance, $R_{Load} (\Omega)$	Input			Output			Efficiency (%)
	Input Voltage, $V_i (V)$	Input Current, $I_{i(mean)} (mA)$	Input Power, $P_i (W)$	Output Voltage, $V_{o(p-p)} (V)$	Output Current, $I_{o(p-p)} (mA)$	Output Power, $P_o (W)$	
50	12	24.67	0.296	10.59	211.9	0.281	94.9
100	12	46.24	0.555	20.74	207.4	0.538	96.9
150	12	63.40	0.761	29.99	199.9	0.749	98.4
200	12	75.89	0.911	37.95	189.7	0.897	98.5
250	12	83.00	0.996	44.39	177.6	0.985	98.9
300	12	84.06	1.009	49.04	163.5	1.002	99.4
350	12	81.60	0.979	51.81	148.0	0.958	97.9
400	12	78.74	0.945	54.11	135.3	0.915	96.8
450	12	76.67	0.920	56.04	124.5	0.872	94.8
500	12	74.91	0.899	57.69	115.4	0.832	92.5
550	12	73.06	0.877	59.12	107.5	0.794	90.5
600	12	71.87	0.862	60.38	100.6	0.759	88.1
650	12	71.34	0.856	61.48	94.59	0.727	84.9
700	12	69.60	0.835	62.47	89.24	0.697	83.5
750	12	68.94	0.827	63.35	84.46	0.669	80.9
800	12	67.79	0.813	64.15	80.18	0.643	79.1
850	12	67.17	0.806	64.87	76.32	0.619	76.8
900	12	66.25	0.795	65.53	72.82	0.596	75.0
950	12	65.76	0.789	66.14	69.62	0.576	73.0
1000	12	65.34	0.784	66.70	66.70	0.556	70.9

From Table I, when the value of load resistor is increasing from 50Ω to 1000Ω , the input power for the system is increasing starting from 50Ω until 300Ω , and then it is decreasing from 350Ω until 1000Ω . The pattern is remaining the same for output power and also efficiency, which are increasing from 50Ω until 300Ω and then decreasing from 350Ω until 1000Ω . The maximum output power that can attain by the system is $1.002W$ with 99.4% efficiency, which the load resistor is 300Ω .

Referring to Table 1, in the range of 250Ω until 350Ω , the input and output power almost reach $1W$; meanwhile the efficiency is above than 97% . Figure 5 shows the plotted graph from the data in Table 1. The graphs show the relationship between load resistances towards efficiency.

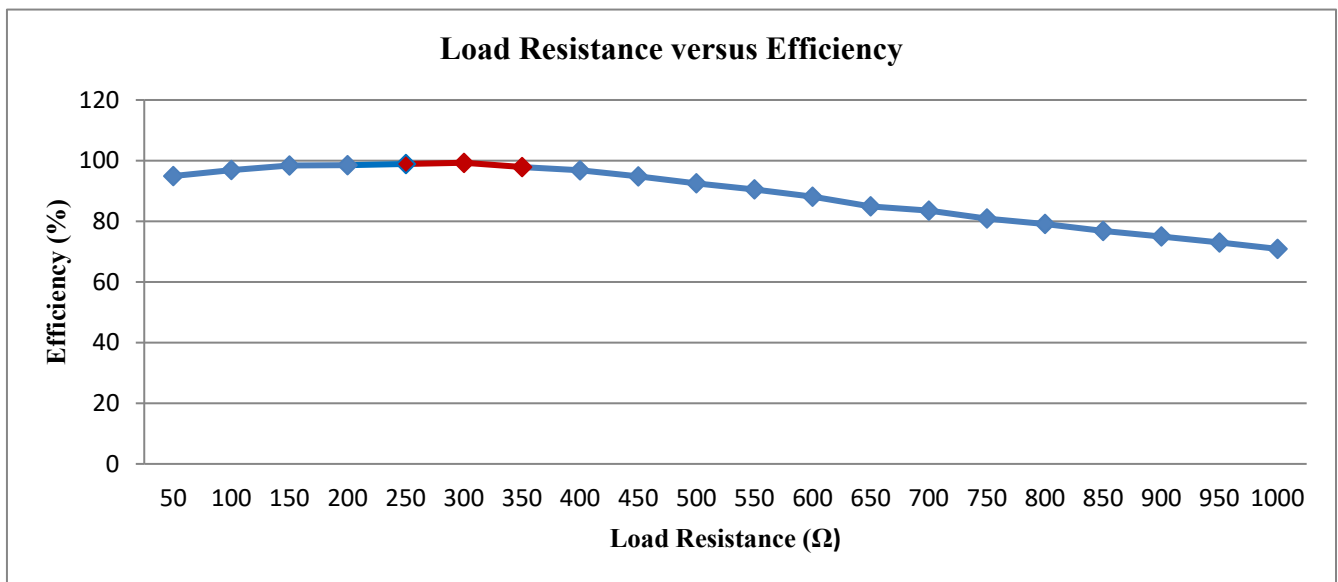
Figure 5. Load resistance, R_L versus efficiency, η at $6.78MHz$ operating frequency

3.2 Coupling Variations

Figure 6 shows the simulation circuit of coupling variations. The data of the load variations is tabulated in Table 2. For coupling variation $\pi 1b$ impedance matching resonant circuit, Capacitor 3, C_3 is manipulated variable meanwhile the system specifications and all the component values are fixed as shown in Figure 6. The Capacitor 3, C_3 is defined by

$$C_3 = \frac{\epsilon_0 \epsilon_r A}{d} \quad (7)$$

Where the ϵ_0 is 8.854×10^{-12} F/m, meanwhile the area, A is 0.063cm^2 . While, the distance, d is changed in order to analyse the coupling variation in the range of 1mm to 15mm.

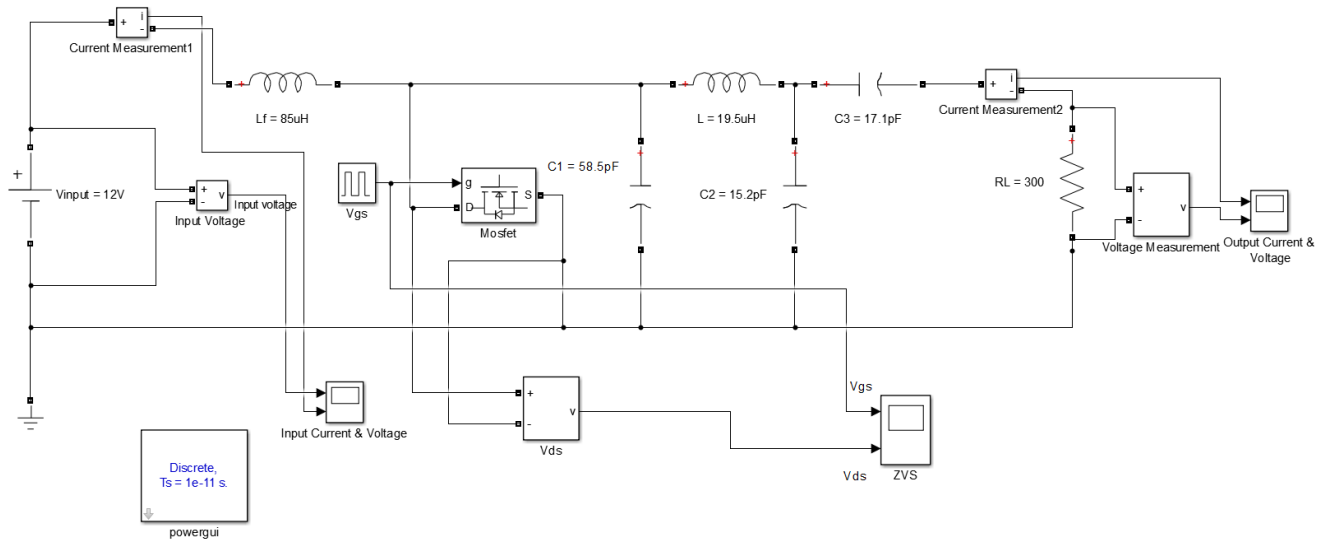

Figure 6. Class E Power Amplifier with $\pi 1b$ Matching Resonant Circuit for Coupling Variations

Table 2. Coupling variations of Capacitive Power Transfer

Distance, d (mm)	Capacitive Coupling Plate, C_3 (pF)	Input			Output			Efficiency (%)
		Input Voltage, V_i (V)	Input Current, $I_{i(\text{mean})}$ (mA)	Input Power, P_i (W)	Output Voltage, $V_{o(p-p)}$ (V)	Output Current, $I_{o(p-p)}$ (mA)	Output Power, P_o (W)	
1	85.5	12	21.92	0.263	16.24	54.14	0.110	41.8
2	42.8	12	20.02	0.240	18.88	62.94	0.149	62.0
3	28.5	12	21.83	0.262	23.12	77.07	0.223	85.1
4	21.4	12	35.56	0.427	31.60	105.30	0.416	97.4
5	17.1	12	84.02	1.008	49.04	163.50	1.002	99.4
6	14.3	12	163.00	1.956	66.03	220.10	1.817	92.9
7	12.2	12	185.30	2.224	58.57	195.20	1.429	64.3
8	10.7	12	161.20	1.934	43.10	143.70	0.774	40.0
9	9.5	12	136.20	1.634	31.73	105.80	0.420	25.7
10	8.6	12	119.10	1.429	24.93	83.09	0.259	18.12
11	7.8	12	106.50	1.278	20.05	66.83	0.167	13.07
12	7.1	12	97.08	1.165	16.54	55.13	0.114	9.79
13	6.6	12	91.40	1.097	14.39	47.98	0.086	7.84
14	6.1	12	86.45	1.038	12.50	41.66	0.065	6.26
15	5.7	12	82.59	0.991	11.14	37.13	0.052	5.25

From Table 2, the efficiency of power transfer is increasing starting from 1mm until 5mm then achieve maximum efficiency which is 99.4%, meanwhile the efficiency is starting decreasing when the distance between two plates is increasing, which started from 6mm until 15mm.

Figure 7 shows the plotted graph from the data in Table II. The graphs show the relationship between distances, D towards efficiency, η .

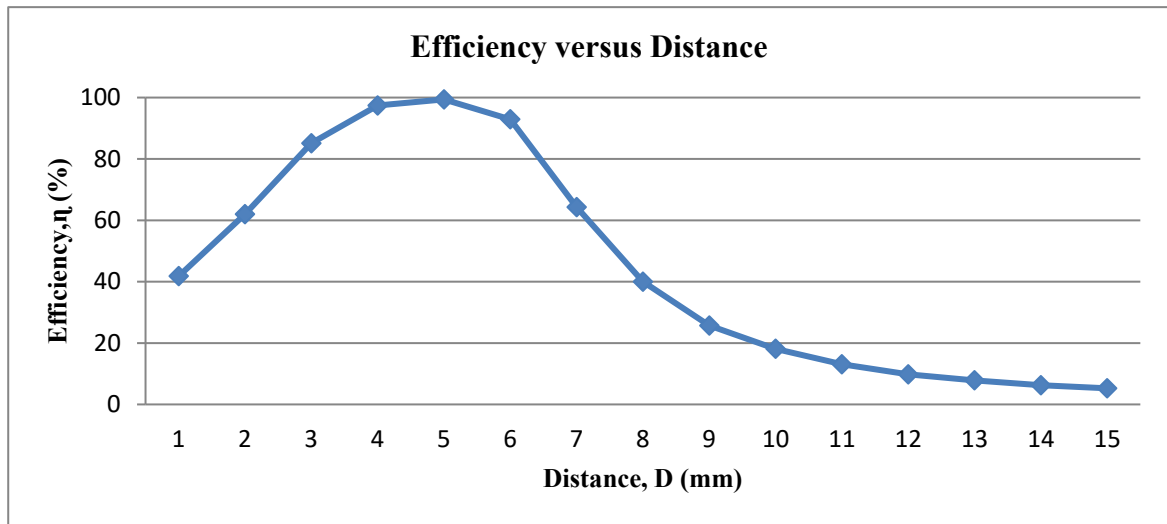

Figure 7. Distance, D versus efficiency, η at 6.78MHz operating frequency

4. CONCLUSION

As a conclusion, from the analysis of load variations, the optimum range for load resistance at 6.78MHz operating frequency is from 250Ω to 350Ω . The range for input power is 0.979W to 1.009W, while the output power is from 0.958W to 1.002W with maintaining 97.9% efficiency and above. Meanwhile, for the coupling variations, the best working distance is between 4mm to 6mm, which achieve above than 90% of power transfer efficiency. This shown, the efficiency of CPT system still can be achieve over 90% and satisfied 1W output power even the load resistance and distance changed in a certain range. For future works, CPT system with self-tuning feedback controller will be proposed in order to enhance the power transfer efficiency directly reduce the power losses.

ACKNOWLEDGMENT

This research was supported by the Universiti Teknikal Malaysia Melaka (UTeM) and Ministry of Science, Technology and Innovation for sponsoring this work under the Fundamental Research Grant Scheme [FRGS/1/2021/TK0/UTEM/02/14].

REFERENCES

- [1] Fei Lu, Hua Zhang and Chris Mi, "A Review on the Recent Development of Capacitive Wireless Power Transfer Technology," *Energies*, 2017.
- [2] Kazmierkowski, M.; Moradewicz, A. Unplugged but connected: Review of contactless energy transfer systems. *IEEE Ind. Electron. Mag.* 2012, 6, 47–55.
- [3] Popovic, Z. Cut the cord: Low-power far-field wireless powering. *IEEE Microw. Mag.* 2013, 14, 55–62.
- [4] Hui, S.; Lee, C. A critical review of recent progress in mid-range wireless power transfer. *IEEE Trans. Power Electron.* 2014, 9, 4500–4511.
- [5] Jawad, A.M.; Nordin, R.; Gharghan, S.K.; Jawad, H.M.; Ismail, M. Opportunities and challenges for near-field wireless power transfer: A review. *Energies* 2017, 10, 1022.
- [6] Bhuvaneshwari S, Dakshayani S, Rakshak B R and Manjula. B. G, "Design and Development of a Capacitive Power Transfer for Contactless Charging of Low Power Devices," *SSRG International Journal of Electrical and Electronics Engineering (SSRG-IJEEE)*, vol. 3, issue 5, May 2016.
- [7] Guilherme G. da Silva and Clovis A. Petry, "Capacitive Wireless Power Transfer System Applied to Low-Power Mobile Device Charging," *International Journal of Electrical Energy*, vol. 3, no. 4, Dec. 2015.
- [8] C. Liu, A. P. Hu, and N. -K. C. Nair, "Modelling and Analysis of a Capacitively Coupled Contactless Power Transfer System," *IET Power Electron.*, vol. 4, no. 7, Aug. 2011.
- [9] C. Liu, A. P. Hu, and N. -K. C. Nair, "Coupling Study of a Rotary Capacitive Power Transfer system," in

- 2009 IEEE International Conference on Industrial Technology, 2009, pp. 1-6.
- [10] M. P. Theodoridis, "Effective Capacitive Power Transfer," *IEEE Trans. Power Electron.*, vol. 27, no. 12, pp. 4906-4913, Dec. 2012.
- [11] C. Liu, "Steady State Analysis of a Capacitively Coupled Contactless Power Transfer System Aihuo Patrick Hu," 2009 IEEE Energy Convers. Congr. Expo., pp.3233-3238, 2009.
- [12] M. Kazimierzczuk and K. Puczkó, "Exact analysis of class E tuned power amplifier at any Q and switch duty cycle," *IEEE Trans. Circuits Syst.*, vol. 34, no. 2, pp. 149-159, Feb. 1987.
- [13] Y. Yusmarnita, S. Saat, A. H. Hamidon, H. Husin, N. Jamal, K. K. Hasan and I. Hindustan, "Design and Analysis of 1MHz Class-E Power Amplifier," *WSEAS Journal*, vol. 14, 2015.
- [14] N. O. Sokal and A. D. Sokal, "Class E – A new class of high-efficiency tuned single-ended switching power amplifiers," *IEEE J. Solid-State Circuits*, vol. 10, no. 3, pp. 168-176, Jun. 1975.
- [15] F. K. A. Rahman, S. Saat, Y. Yusop, H. Husin, and Y. Aziz, "Design and Analysis of Capacitive Power Transfer System with and without the Impedance Matching Circuit," *International Journal of Power Electronics and Drive System (IJPEDS)*, vol. 8, no. 3, pp. 1260-1273, Sept. 2017.
- [16] Thomas L. Floyd, *Principles of Electric Circuits Conventional Current Version*, 9th ed. Pearson, 2010. ISBN-10: 0-13-245312-6.
- [17] Teck Chuan Beh, Takehiro Imura, Masaki Kato and Yoichi Hori, "Basic Study of Improving Efficiency of Wireless Power Transfer via Magnetic Resonance Coupling Based on Impedance Matching," *IEEE International Symposium on Industrial Electronics*, Nov 2010.
- [18] A.G. Radwan, A. Shamim and K. N. Salama, "Theory of Fractional Order Elements Based Impedance Matching Networks," *IEEE Microwave and Wireless Components Letters*, Vol. 21, No. 3, Mar 2011.
- [19] Wei Zhang, Chunting Chris Mi, "Compensation Topologies of High-Power Wireless Power Transfer Systems," *IEEE Transactions on Vehicular Technology*, Vol. 64, Issue: 6, July 2015.
- [20] Covic, G. A. and J. T. Boys, "Modern Trends in Inductive Power Transfer for Transportation Applications," *IEEE Journal of Emerging and Selected Topics in Power Electronics*, pp. 28-21, 2013.
- [21] Keeling, N.A., G. A. Covic and J. T. Boys, "A Unity-Power-Factor IPT Pickup for High-Power Applications," *IEEE Transactions on Industrial Electronics*, pp. 744-751, 2010.
- [22] Elliott, G. A. J., et al., "A New Concept: Asymmetrical Pick-Ups for Inductively Coupled Power Transfer Monorail Systems," *IEEE Transactions on Magnetics*, pp. 3389-3391, 2006.
- [23] Norezmi Jamal, Shakir Saat, A. Z. Shukor, "A Study on Performances of Different Compensation Topologies for Loosely Coupled Inductive Power Transfer System," *IEEE International Conference on Control System, Computing and Engineering*, Jan 2014.
- [24] Kateryna Bazaka and Mohan V. Jacob, "A Review of Implantable Devices: Issues and Challenges," *Electronics*, ISSN 2079-9292, 2013.
- [25] Alghairi, M.K., Sulaiman, N. Bin, Mohd Sidek, R.B., and Mutashar, S., 2016. Optimization of spiral circular coils for bio-implantable micro-system stimulator at 6.78 MHz ISM band. *ARPN Journal of Engineering and Applied Sciences*, 11(11), pp.7046–7054.
- [26] Bischof, G., Scholnick, B., and Salman, E., 2011. Fully integrated PLL based clock generator for implantable biomedical applications. 2011 IEEE Long Island Systems, Applications and Technology Conference, LISAT 2011, pp.4–9.
- [27] Hannan, M.A., Hussein, H.A., Mutashar, S., Samad, S.A., and Hussain, A., 2014. Automatic frequency controller for power amplifiers used in bio-implanted applications: Issues and challenges. *Sensors (Switzerland)*, 14(12), pp.23843–23870.
- [28] Harrison, R.R., 2007. Designing efficient inductive power links for implantable devices. *Proceedings - IEEE International Symposium on Circuits and Systems*, (2), pp.2080–2083.
- [29] Seo, D.W., Lee, J.H., and Lee, H., 2016. Integration of Resonant Coil for Wireless Power Transfer and Implantable Antenna for Signal Transfer. *International Journal of Antennas and Propagation*, 2016.
- [30] Evgeny Katz, (2014), *Implantable Bioelectronics*, Wiley, ISBN: 978-3-527-33525-1
- [31] Kara N. Bocan and Ervin Sejdic, "A Review of Adaptive Transcutaneous Power Transfer to Implantable Devices: A State of the Art Review," *Sensors*, 2016.