



Journal of Advanced Research in Fluid Mechanics and Thermal Sciences

Journal homepage:
https://semarakilmu.com.my/journals/index.php/applied_sciences_eng_tech/index
ISSN: 2462-1943



Advancement of Underwater Surveying and Scanning Techniques: A Review

Wan Hafiza Wan Hassan^{1,*}, Mahfuzah Md Shukor¹, Faezah Jasman², Zaiton Abdul Mutalip³, Mohd Shafizal Abdullah⁴, Sevia Mahdaliza Idrus⁵

- ¹ Faculty of Ocean Engineering Technology and Informatics, Universiti Malaysia Terengganu, 21030 Kuala Nerus, Terengganu, Malaysia
² Institute of Nano Optoelectronics Research and Technology (INOR), Universiti Sains Malaysia (USM), 11800 USM, Penang, Malaysia
³ Centre for Telecommunication Research & Innovation (CeTRI), Faculty of Electronics and Computer Engineering, Universiti Teknikal Malaysia Melaka, Hang Tuah Jaya 76100 Melaka, Malaysia
⁴ iSmartUrus Sdn. Bhd. No. 25 & 25A, Jalan Pulau 26, Taman Pulau Utama, 81300 Skudai, Johor, Malaysia
⁵ Faculty of Engineering, Universiti Teknologi Malaysia, 81310, Johor, Malaysia

ARTICLE INFO

Article history:

Received 15 May 2023
Received in revised form 13 September 2023
Accepted 25 January 2024
Available online 20 March 2024

Keywords:

Sonar; LIDAR; surveying; scanning; underwater

ABSTRACT

Underwater scanning and surveying (USS) plays a significant role in tactical surveillance, offshore explorations, climate change monitoring, and oceanography research. USS is required to accurately obtain the 3-D geometry information of an underwater object and determine the underwater area of interest respectively. This paper reviews the state-of-the-art USS by discussing the operations, characters, advantages and disadvantages of the sensors used in each of the techniques. It classifies the sensors based on the carrier signals which are acoustics and optical signals. A hybrid technique is then proposed by integrating both acoustics and optical approaches for the scanning technology and utilizing artificial intelligence and OWC technologies to improve the system's accuracy and latency. The structured review of these techniques will give insight into the future advancement of USS and improve its quality of service.

1. Introduction

Underwater environment covers 71% of the earth's surface with the oceans hold about 96.5% of all earth's water and only 5% of them can be considered explored. The enormous amount of water content has triggered curiosity and instinct of humankind from various generations to explore and conduct research on the ocean. The ocean exploration is not limited to exploring marine ecosystem, mining valuable resources from the sea or observing the variety of biological change underwater, but it can produce many beneficial information regarding natural disasters, climate change and not to mention the important historical findings about the earth. Recently in 2021, the whole world was in shocked with the sinking of Indonesian submarine KRI Nanggala and prior to that in 2014 with the disappearance of civilian aircraft MH370 which is yet to be found till now. These incidents left a huge

* Corresponding author.

E-mail address: whafiza@umt.edu.my

<https://doi.org/10.37934/araset.41.2.256281>

impact and served as a wake-up call on the plethora of issues that is yet to be explored in underwater environment [1]. Lack of seafloor maps is one of the factors that has significantly limited the progress of human investigation and understanding of the oceans [2].

Well equipped with the knowledge on the underwater environment and the seabed is one important requirement prior to carrying-out any activity to ensure all the planned activities are safe to be executed and meet the target. Advancement of surveying and scanning technologies has improved the process of gaining required information and underwater images. These technologies are used for imaging, topological mapping (bathymetrical) range finding, dredging and water property sensing in a variety of fields as has been listed earlier by Rumbaugh *et al.*, [3].

Underwater surveying is the process of accurately determining the area of interest of the seafloor with the aim to measure and fix a position in three dimensions while underwater scanning is the process of obtaining the 3D geometry information of an underwater object accurately [4]. Figure 1 classifies underwater surveying and scanning technologies into two different approaches, using acoustic and optical signal respectively. Variety of low-cost and high-resolution ocean observation devices have been developed and equipped on various platforms, such as single-beam sonar, multibeam sonar, side-scan sonar, optical imaging and underwater LiDAR [2].

The rest of the paper will review each existing technique as classified in Figure 1. Section 2 and 3 discuss techniques using acoustics signal and optical signal respectively. Section 4 proposes a high precision underwater scanning system and outlines the anticipated challenges. Section 5 concludes the paper.

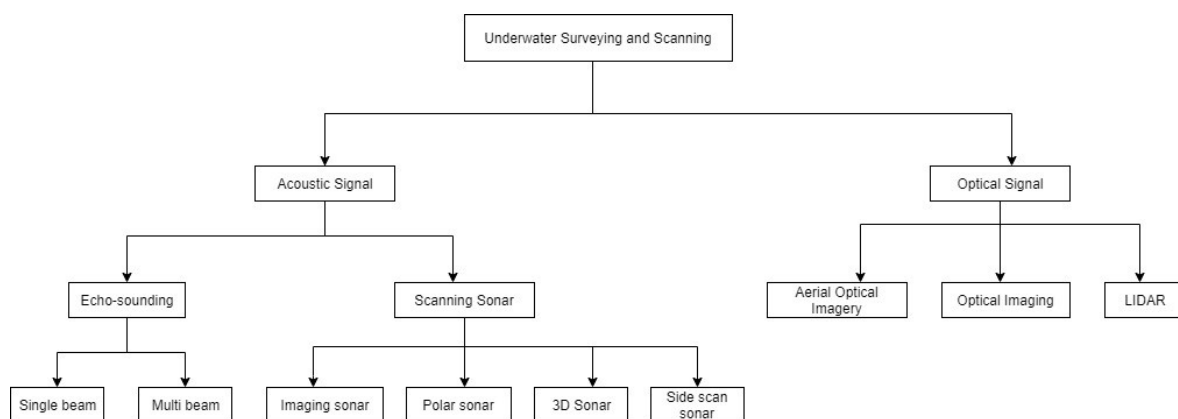

Fig. 1. Classifications of Underwater Scanning and Ranging Techniques [5,6]

2. Acoustic Approach

Acoustic approach is the most common method used in underwater environment because it offers high sensor range, robust to turbidity and long-range links as it suffers from relatively minimum signal absorption. Sonar which stands for Sound Navigation and Ranging system is the technology that uses the reflection of sound waves propagation to navigate, communicate or detect objects underwater. Practically, sonar is used to see what lies beneath the waves and divided into two types which namely passive and active sonar. Passive sonar receives pings without transmitting their own sound signals and is used in surveillance. In contrast, active sonar receives a return echoed sound after sending out sound pulses, or pings. The basic operating principle of sonar system is illustrated in Figure 2. The transducer converts the input wave into sound wave and emits the wave towards the target object. Then, it waits for a period to receive the return of the transmitted signal (reflected signal), after the sound wave hits the targeted object.

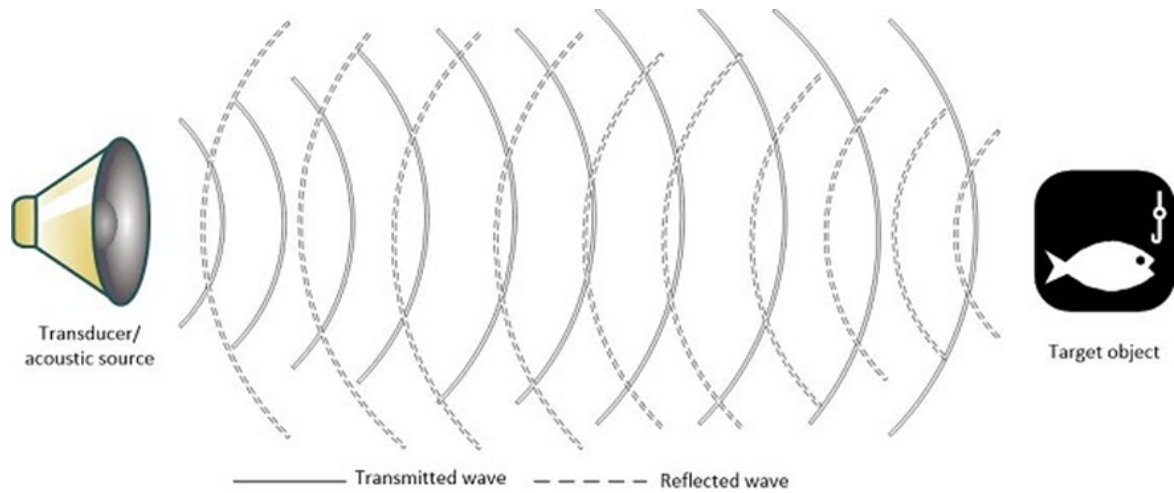

Fig. 2. Basic Principle of Active Sonar System [7,8]

Table 1

Characteristic comparison among active sonar systems Paull *et al.*, [9]

Type of sonar system	Echo-sounding	Side scan sonar (SSS)	Mechanically scanned imaging sonar (MSIS)	Forward scan sonar (FSS)
Accuracy	<ul style="list-style-type: none"> • more accurate than single beam • Less accurate in muddy water. 	Less accurate than FSS.	<ul style="list-style-type: none"> -Less accuracy due to slow scanning rate. - depending on AUV attitude. 	<ul style="list-style-type: none"> • More accurate • Able to penetrate in turbid water.
Speed	Multi-beam faster than single beam	Faster than MSIS	Slower scanning rate	<ul style="list-style-type: none"> • Varies with scanning range. • Faster for shorter rangel and slower for longer range.
Sensor size	Bulky	Bulkier than echosounder	Small	Varies with the ship size.
Resolution	Returned acoustics echoes.	Proportional with the operating frequency and inversely proportional with the range.	High	Higher than MSIS
Sensor output dimension		1-D (mage)	2-D (Image)	2-D and 3-D (image)
Operating frequency	10.5-13.5 KHz	100-500 KHz	675 KHz (nominal) 800.z	≥ 1 MHz
Applications	Single Beam	- Robust automatic	- Sonar scan matching for an AUV [16]	- Autonomous underwater

- Exploration in Underwater Tunnels [10]	- landmark detection[14]	- Probabilistic sonar scan matching SLAM for underwater environment [17]	harbor surveillance[18];
- Autonomous Exploration and Mapping of Flooded Sinkholes [11]	- Localization and Map Building of Underwater Robots [15]		
Multibeam			
- bathymetric SLAM using distributed particle mapping [12]			
- Bathymetric particle filter SLAM using trajectory maps [13]			

Active sonar system is used for communications, navigation, detection, and tracking [19]. Thus, this paper reviews active sonar systems which have been further classified into several types as shown in Figure 1. In summary, Table 1 compares the characteristics of the active sonar systems and the detailed review for each sonar system is presented in the following sections.

2.1 Echo-Sounding Sonar

Echo-sounding is a type of sonar technology which transmits sound pulses into water to determine the depth of water by measuring the time interval between emission and return of a pulse along with the speed of sound in water at the time. Besides, this technology is also used in the studies of fishery and marine habitats as reported in Parnum *et al.*, [20]. The echo-sounding assessments can be carried-out either through mobile surveys from boats to evaluate marine biomass or fixed location where a static transducer is used to monitor passing marine life [3]. The echo-sounder used in this system can be either single beam or multi beam echo sounder. A single beam echo-sounder comprises a transmitter and a receiver which uses a pulse of sound to travel vertically from the transmitter located under a ship or an underwater vehicle to the sea bottom and return as described in Lurton & Lamarche [21]. As a result, a bathymetric map is created after the area between the survey lines is measured. The system can be used both in shallow and deeper waters, but it is limited to less accuracy particularly when muddy layers are encountered. Alternatively, a multi-beam echo-sounder offers higher accuracy as it uses a larger number of sound beams mounted in an arc as proposed in Hao *et al.*, [22]. The quality of the transmitted sound using a multi-beam system is enhanced by having at least hundreds of transducers, whose output can be combined and consequently gives good accuracy of the sea floor's surface calculation. Figure 3 illustrates the schematic representation of the three main types of seafloors -mapping sensors.

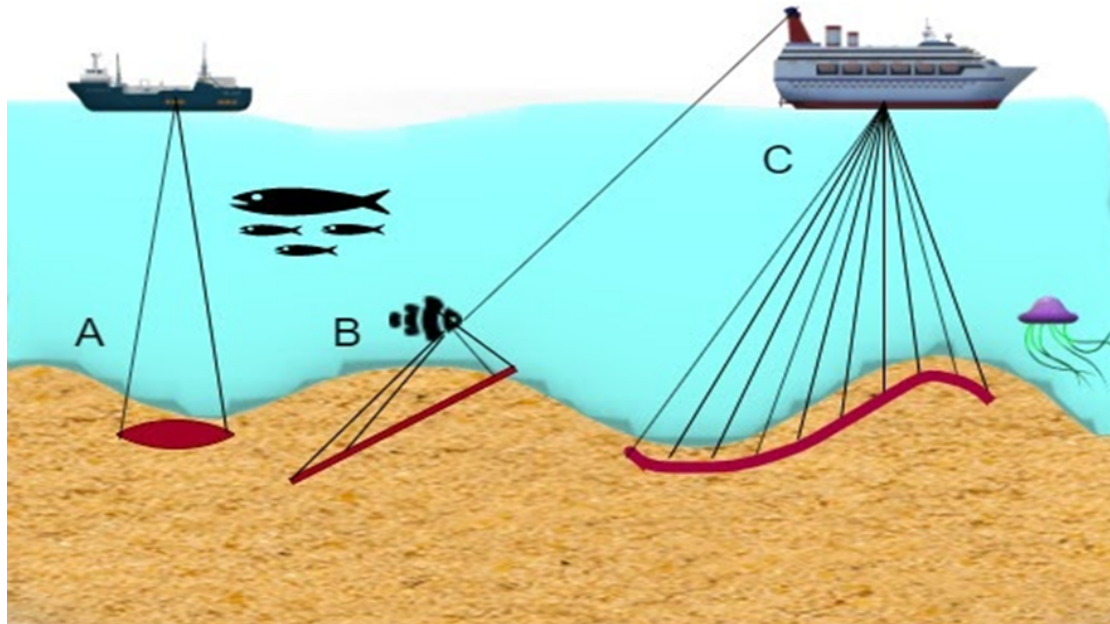

Fig. 3. Schematic Representation of the Three Main Types of Seafloor-Mapping Sonars (A: Single-Beam Echosounder; B: Sidescan Sonar; C: Multibeam Echosounder) [21]

2.2 Side Scan Sonar

Side-scan sonar (SSS) is a type of sonar technique that is used to create images of large areas of the sea floor. These images are often used for detection of man-made objects on the seafloor, e.g., pipelines, ships, or mines as in Padial *et al.*, [23] and Reed *et al.*, [24]. The conical or fan-shaped pulses are emitted down toward the seafloor across a wide angle perpendicular to the path of the sensor through the water. It is towed at a low altitude above the seafloor from a surface vessel or submarine or mounted on the ship's hull as illustrated in the middle of Figure 3. The interface details of the acoustic images are recorded at shallow grazing angles.

In contrast to multibeam sonar which returns range for time-of-flight values, the SSS returns intensities. Hence, unavoidable ambiguity is anticipated in extrapolating spatial information from SSS data that require some assumptions (e.g. flat bottom) to be made [23]. The intensity of the acoustic reflections from fan-shaped beams at the seafloor is recorded in a series of cross-track slices. When stitched together along the direction of motion, these slices form an image of the sea bottom within the swath (coverage width) of the beam.

Autonomous underwater vehicles (AUV) are commonly equipped with SSS to efficiently create large scale images due to low cost and ease of deployment as claimed by Burguera & Oliver [25]. However, SSS is only limited to capture 1-dimension image segments and 2-d image is synthesized over time by concatenating the 1-d image segments [26].

The common frequency range used in SSS is from 100 to 500 kHz. The resolution of the obtained sonar images is proportional with the operating frequency. Higher frequency results in better resolution but at reduced range. Several studies work on improving the quality of SSS imagery. The improvement of the uneven brightness inherent in the sonar data by using a normalization process based on the average signal intensity for each grazing angle has been established in Chang *et al.*, [27]. A more complex work in Burguera & Oliver [25] is proposed to improve the mapping resolution of SSS images using a probabilistic approach that considers the seabed reflectivity and the wave incidence angle. The work in Galdran *et al.*, [28] proposed an inhomogeneity correction technique to utilize two-dimensional information in estimating the presence of non-uniformities consequently

removing the non-background pixels and improved the imagery quality. Further, Shang *et al.*, [29] recently proposed an integration model of SSS-based reconstructed results and bathymetric data in the same surveying area as an effort to obtain high-resolution and -accuracy topography.

2.3 Mechanically Scanned Imaging Sonar

Mechanical scanned imaging sonar (MSIS) is a type of sonar which performs scans in a horizontal 2-dimensional plane by rotating a mechanically actuated transducer head at pre-set angular increments. As it rotates, it transmits and receives acoustic pulses to build a 360-degree image of the surroundings [30,31]. The image is obtained by accumulating the returned distance vs. echo-amplitude data for each emitted beam along a complete 360 degree [32].

Figure 4 illustrates the obtained acoustic fan shaped beam with a narrow horizontal and a wide vertical beam width resulted from each angular position of MSIS. The acoustic beam emitted from the transducer propagates through underwater environment, hits any object (obstacle) in its path and consequently returns the transmitted energy as a mechanical wave back to the transducer [33,34].

The range at which the signal originated can be determined by measuring the time of flight of the returning wave and assuming a known value for the speed of sound in water. However, MSIS devices have a slow scanning rate, for instance: the proposed sensor in Burguera *et al.*, [30] requires more than 13 seconds gathering a full scan and Tritech Miniking Sonar reported in Ribas *et al.*, [32] needs 6 seconds to complete. As a result, it induces distortions in the acoustic image MSIS sensor, unable to determine the object position in the vertical plane though it can detect 3D objects. These limitations caused image inaccuracies which led to poor results. Therefore, several works have been proposed on techniques to improve the accuracy of MSIS images. The most popular approach is the scan matching algorithm to estimate sensor motion as proposed in Zandara *et al.*, [35].

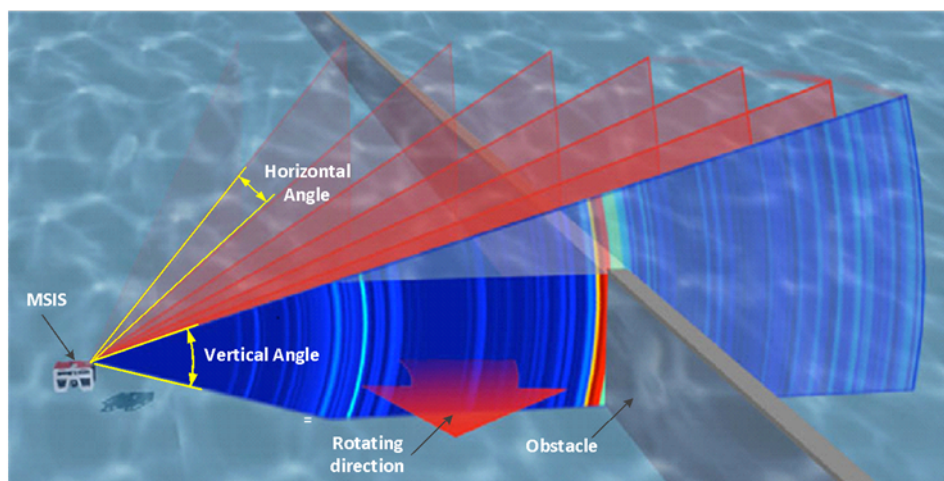

Fig. 4. Illustration of MSIS Scanning Process [30,32]

2.4 Forward Scan Sonar

Forward scan sonar (FSS) is widely used as underwater sensors because it offers a longer operating range and higher resolution than other sonar systems Sung *et al.*, [36]. FSS is primarily devoted to surface ship navigation, object detection or obstacle avoidance in shallow-turbid underwater environments [37-40]. FSS can penetrate in the turbid water making it a suitable solution to replace the optical system which has limited operation in such an environment. It is due to poor

visibility by optical cameras caused by interaction of suspended particles within the water column which directly attenuated the light.

FSSs are mounted on the bow of the vessel and transmit multiple fan-shaped acoustic waves at various azimuth angles as shown in Figure 5. One column of solar image is formed by the reflected acoustic wave that has returned to FSS from every single scan. Then, the time-of-flights (TOF) and the intensity of the reflected waves are measured by FSS to generate a 2D sonar image after mapping the intensity of acoustic waves according to the distance and azimuth angle between the sonar sensor and reflected point. Thus, the generated image reflects the backscatter strength of scene surfaces at varying distances from the sonar in various azimuth directions.

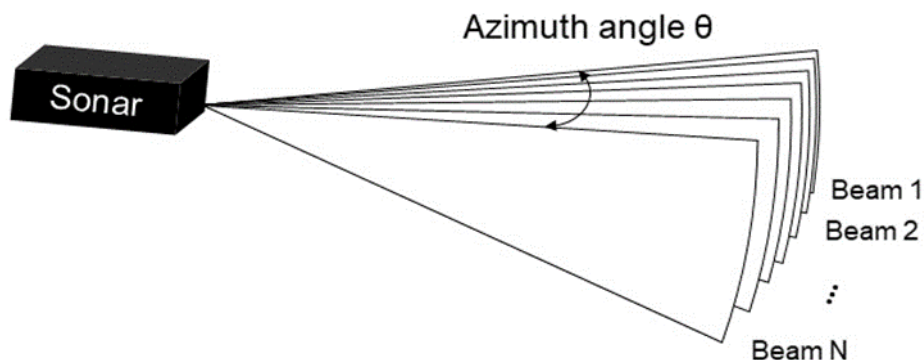

Fig. 5. Forward Scan Sonar (FSS) Using Multiple Acoustic Waves [36]

Despite being mainly used in shallow-turbid water environments, many works in literature studied enhancing the FSS image formation process as a platform to further enable the development of more accurate image interpretation techniques [41]. Image processing algorithms have been widely proposed and employed into FSS images for accurate underwater object detection purposes. For instance, Galceran *et al.*, [42] proposed an automatic target recognition algorithm to detect man-made objects in FSS imagery. The method utilizes the integral-image representation to quickly compute features on smaller portions of the image along the detection process phases. Further, the work in Kim & Yu [43] detected a target object in various angles of view using a sonar image simulator-based underwater object recognition algorithm which matched the simulated image with the actual sonar image by means of a beam-based template. On the contrary, Hassan [44] detected an object by employing an adaptive boosting algorithm that combined multiple Haar-like features for the weak classifier with adaptive boosting for the strong classifiers. However, these algorithms may exhibit limited accuracy and relatively high false positive rate due to the fact that the shape of the object changes significantly depending on the sonar's view point [36]. Thus, methods for reconstruction of 3-D images from one or multiple 2-D images obtained by FSS have been broadly studied to improve the accuracy of object detection in various applications. The work in Xie *et al.*, [45] introduced an acoustic stereo imaging (ASI) system using two FSS in vertical configuration to reconstruct the 3D scanned scene. This method is claimed to be cheaper in implementation than planar array sonars and able to solve the delay problem in T configured 3D sonars. Furthermore, Pyo *et al.*, [46] proposed a continuous 3D reconstruction method for unmanned underwater vehicles using the geometry of FSSs while Tulsook *et al.*, [47] reconstructed 3D images based on pixel correspondence between two sonar images obtained from different locations. Later Murat and Negahdaripour [41] progressed further by proposing another 3-D reconstruction from multiple FS sonar images using space carving methods which do not require knowledge of ambiguous and noisy backscatter measurements [45].

Similar to other sonar images, FSS imaging is also limited to high noise, crosstalk and low contrast due to the fact that FSS processes echo information from acoustic signals [46,47]. Hence, a number

of works are focusing on minimizing the noise that degrades the FSS images quality. The work in Pyo *et al.*, [46] enhanced sonar images using Gabor filter prior to extracting the underwater objects and consequently adopted Kalman filter as the tracking method. Recently, a real-time undersea pipeline extraction for FSS images using the self-organizing map was introduced in Jing *et al.*, [48]. The mislabeled pixels are first removed using a false alarm suppression algorithm after the FSS images have been segmented using the cell-averaging constant false alarm rate detector.

Finally, the segmented pixels are joined together by means of a self-organizing map. Latest works in Sung *et al.*, [36] and Alom *et al.*, [49] use a neural-network approach to detect and remove crosstalk noise based on the detection results while the later improved the accuracy of underwater multiclass target recognition tasks using deep convolutional neural networks. It is expected that many further works will evolve using these deep-learning approaches soon as this technique is able to extract high-level features from mass data automatically through the learning process [50].

3. Optical Approach

An optical approach uses light waves as the carrier to navigate, communicate or detect objects underwater. It is regarded as an alternative to principal acoustic method for underwater surveying and scanning because acoustic approach has limited resolution, and the accuracy is not suitable for certain measurement tasks [5].

Relative to acoustic, the optical approach offers higher resolution and better accuracy because of the nature of light waves that provides higher transmission bandwidth and faster data rate with low latency [51]. However, propagation of optical waves in the underwater environment is triggered by an interaction between each photon and seawater particles which causes the signal attenuation and consequently limits the scanning and surveying range. Therefore, most underwater optical systems have the constraint of limited range, susceptibility to scattering, and inadequacy of lighting [9]. In what follows, three main optical systems as classified in Figure 1 are discussed by reviewing their working operation, advantages and limitations.

3.1 Aerial Optical Imaginary

Aerial optical imaginary (AOI) technique produces an aerial image which is a projected image that cannot be viewed directly as it is floating in air. Thus, it can be viewed only from one position in space and normally focused on another lens. As for underwater environment, the apparent position, size and shape of aerial objects viewed binocularly from water change as a result of the refraction of light at the water surface [52].

The AOI technique in Flener *et al.*, [53] is applicable in shallow waters as an alternative to echosounder technique which is constrained by the inability of vessels to safely pass through the area. Relative to other techniques, AOI can record additional information including surface features, water column characteristics, as well as seabed topology and substrate reflectivity [54]. By analyzing the recorded data of individual pixels, differences in reflectance measurements can be correlated between water depth, bottom substrate colour and water column colour by referencing known depth data, which can then be applied to the remaining pixels to estimate water depth (bathymetry) in the remainder of the image [55]. However, it should be noted that AOI is a passive optical imaging technique which is fully dependent on sunlight. Theoretically, sunlight can penetrate beneath the water surface up to 30 meters in clear coastal water but practically, the visibility is limited to 10 – 13 meters because of water turbulence and turbidity [56]. This constraint leads to misinterpretation of data in bathymetry due to inability to distinguish causes of reflectance although AOI provides

excellent spatial coverage in short time periods [57]. In addition, water depth, turbulence, turbidity, sun glint and atmospheric absorption are among other factors that may increase the complexity of AOI technique in obtaining depth measurements [58]. Ideally, AOI requires clear and unobstructed views of the survey area which is nearly impossible to happen considering the real atmospheric conditions and natural obstructions [54]. As such, the works in Shintani & Fonstad [55] and Kasvi *et al.*, [59] compared techniques to improve the accuracy of bathymetric data using radiative transfer methods.

3.2 Underwater Optical Imaging

Underwater optical imaging allows underwater vision became feasible, enable mankind to observe underwater environment. The optical imaging devices can provide good and high quality of image due to the underwater conditions which are dark, fast flowing, and murky. An underwater image is a linear superposition of a direct component consisting of forward scattering and backscattering components [60].

The basic concept of underwater imaging systems consists of light from light sources such as the sun, underwater lights or bioluminescent creatures to the receiver which is a camera, as described in Jaffe [61]. The light received by the camera either consists of light reflected by the object or not reflected by the object; the latter or known as backscatter. Light reflected by the object has two components which are light that is not scattered in the intervening water and another one is light that has been scattered at a small angle or known as forward scatter. The light separation, contrast and power are dependent on the underwater environment. Figure 6 and 7 show the underwater optical model where the forward scattering components are represented as reflected light of the object in the underwater medium while the back scattering represents interaction between underwater ambient light and also underwater suspended particles [62]. A wide range of underwater imaging can be achieved by using an artificial light source as auxiliary light source [61].

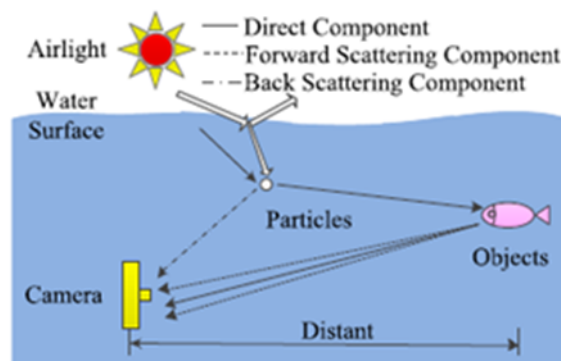

Fig. 6. Underwater optical imaging model [62]

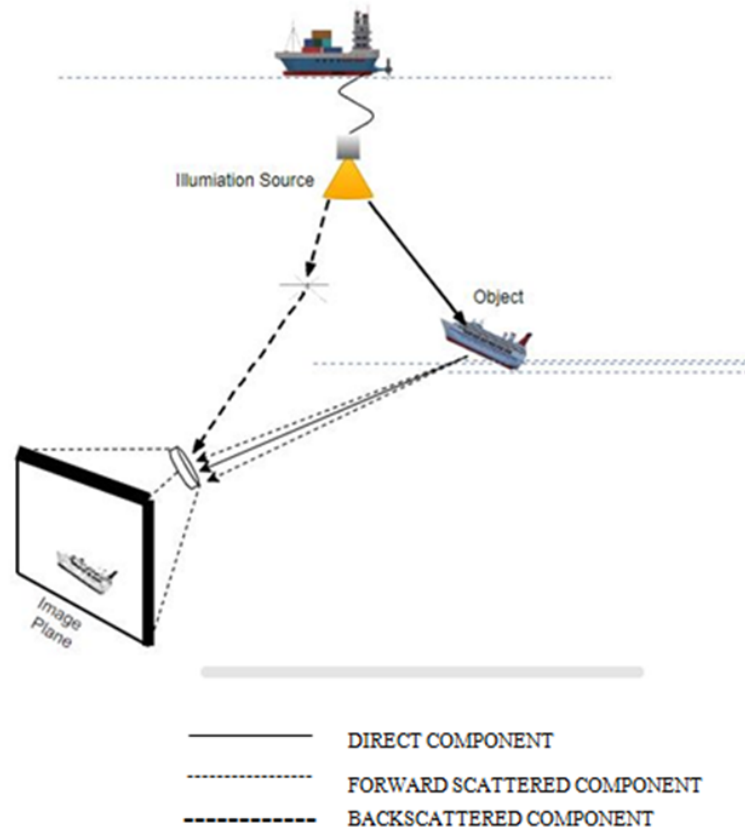

Fig. 7. Three Imaging Components in the Underwater Imaging System [61]

Underwater optical imaging systems can be divided into two types of systems which are passive and active systems. Passive system is when the image is generated by some source other than that correlated with the imaging system. Passive systems use ambient or external light from the sun. The active system is an image generated by the source of light. Active system can be a conventional image or extended range image when the source of light is located near the camera [59,61].

However, images captured in a turbid underwater environment are of very poor quality. The underwater images are degraded by the attenuation and backscattering of light due to its interaction with dissolved and particulate materials in the water [64].

Therefore, image processing is needed to enhance the image and the contrast of the original image, reducing the underwater interference and scattering effect. The function of image segmentation is to separate the target from the background while the mathematical morphology processing is to detect the underwater target accurately. Edge detection is to create grey values of the pixels around the edge and edge recognition is to detect the edge line of the image. The original image undertakes 5 stages to be processed according to underwater optical image processing technique as summarized in Figure 8 [65].

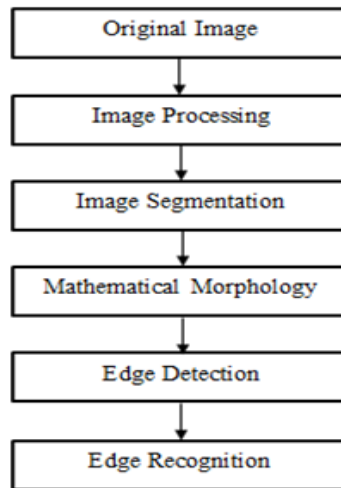

Fig. 8. Flow of Underwater Optical Image Processing [65]

Underwater optical imaging enhancement techniques can be classified into two types of methods, hardware, and software method. Each method has several techniques that have been proposed in the literature.

Table 2
 Underwater Optical Imaging Systems Methods

Methods	Techniques		Details
Hardware	Polarization (Passive Imaging)	Polarization Filter [66]	<ul style="list-style-type: none"> To receive the biased images by attaching the filter in front of the camera. Capture the image immediately. Reduce noise.
		Polarization Light Source [67]	<ul style="list-style-type: none"> Capture different illuminated images of the same scene Capture image immediately Reduce noise The state-of-the-art polarization imaging method for underwater has been proposed
	Active Imaging	Range-Gated Imaging [68,69]	<ul style="list-style-type: none"> Widely used for laser imaging systems in turbid water. Produce a short pulse of light that can be used in coordination with an underwater receiver. Provide precise light gating in the camera receptor.
		Conventional Image Acquisition [63,67]	<ul style="list-style-type: none"> Distinguish objects under water within the range Provide the distance of underwater vision up to one meter Map a variety of different habitats that range from the sea floor to both man made and biological subjects.

		Extended Range Imaging [63]	<ul style="list-style-type: none"> • Reduce the typical contrast limited in the conventional system caused by volume scattering.
		Narrow Beam Systems [63,70]	<ul style="list-style-type: none"> • Offer the highest possible resolution if enough signal is received • To obtain excellent contrast and resolution
		Fluorescence Imaging [71,72]	<ul style="list-style-type: none"> • Recover the shape of an underwater scene. • Fuse the turbidity of a hazy image by proposing a different direction lighting method.
		Stereo Imaging [73]	<ul style="list-style-type: none"> • Recover underwater images by estimating the visibility coefficients • Designed by real time algorithms and implemented into AUVs. • Visibility coefficients estimation
Software	Wavelength Compensation (Sediment Scattering)	Physical Model [74-77]	<ul style="list-style-type: none"> • Predict the turbidity of haze (Color-lines Method) • Recover clean images (Markov Random Field Model) • Approximate the depth map (Dark Channel) • Achieve real time processing, clear images and refine depth map (Guided Filtering) • Restore underwater image (Dehazing Method) • Flickers found in underwater image (Robust Ambient Light Estimation Method and underwater median dark channel prior for de scattering.
		Non-physical model [78-82]	<ul style="list-style-type: none"> • Address non-uniform lighting and haze (Local Histogram Equalization) • Adjust target region (Contrast Limited Adaptive Histogram Limited Adaptive Histogram Equalization – CLAHE) • Combines different exposed images via filtering (Espouse Fusion Method) • Overcome noise and scattering (Kemel-Size De-Scattering Method) • A single image dehazing method using depth map refinement. • To enhance image (Frequency Domain Filtering Method) • Underwater image enhancement algorithm using an integrated color model.
		Colour reconstruction (Light Absorption) [83,84]	<ul style="list-style-type: none"> • Predict related colour value for each pixel (Markov Random Field (MRF) Learning Method) • Compute the attenuation coefficients using the depth map (Hyperspectral Imaging and Mathematical Stability Model) • Recover the contrast of the colors (Spectral Response Model)

Table 2 classifies and summarizes the existing techniques on enhancing the underwater optical images. Active and passive imaging techniques are two main hardware-based techniques. The latter technique utilizes polarization filter and light source to reduce the noise in the captured image. In contrast to the active imaging where there are variety of methods including range-gated imaging, conventional image acquisition, extended range imaging, narrow beam systems as well as fluorescence and stereo imaging.

On the other hand, software approach of underwater optical imaging systems employed physical and non-physical model for wavelength compensation technique based on sediment scattering. Another software approach is the colour reconstruction based on light absorption. This technique is proposed to predict related value for each pixel and recover the contrast of the colours.

The performance of the underwater imaging can be measured based on the total attenuation length where the system can provide good quality of image. The conventional system with specific coordinate position of camera and lights can produce a good image at distance of one attenuation length but at a wide range the image produced is contrast limited. The underwater optical imaging system performance is also dependent on the light brightness and camera sensitivity. Xenon, LED and laser are the most methods to be used to generate light and LED which can provide low power consumption and waterproof which is suitable to be used in water [63]. The wavelength of the emitted light also contributes to the system performance where the blue light with shortest wavelength can travel the longest in the water followed by the green light and lastly the red light [60].

A work in Chen *et al.*, [65] presents optical detection of underwater robots for submarine cables by using image recognition. A model called "UNCLES" for UNderwater Camera Light Experimental System has been developed by the Visibility Laboratory, at the Scripps Institution of Oceanography, U. C. San Diego [85]. Physics-based method is used in Li *et al.*, [60] to recover the visibility and colour of the image even in the challenging underwater environment. An experiment has been developed in Mortazavi *et al.*, [86] to analyse the results of the proposed filter to improve the multispectral underwater images and also recover the pixel spectra. A study in Haocheng *et al.*, [70] has developed a new underwater optical model to enhance the underwater images or video frames.

Underwater optical imaging contributed many advantages to the technology development such as low-cost image processing software and hardware, good quality of camera, compact, efficient, simulation and modelling that provide accurate prediction of changes in the sea water, increased data rate transfer with high quality standardization such as streaming video [63]. An application for long term monitoring is built by expanding conventional cameras where it can produce measurements, identification, assessment, image scaling, 3-D reconstructions, and analysis [87,88]. Those camera systems can operate at long term with high bandwidth data and also extensive resolution. Besides that, underwater optical imaging can reduce limiting factors under different situations [89]. Furthermore, modern imaging sensors for underwater applications can operate at high speed and provide dense information.

However, the main challenge for underwater optical imaging is absorption and scattering properties in seawater, single image coverage which is limited to a few square meters, produce poor quality of the image and also increase noise interference [64,65]. Both challenges will lead to degradation of the underwater videos or images quality where scattering will blur the image produced and absorption will produce colour distortion, contrast and also brightness reduction [62]. Scattering redirects the angle of the photon path while absorption removes the photon path from the light. The underwater optical imaging is affected by the scattering phenomena based on the water volume that is intersected by the field of view of the camera and also the illumination source. Recently, the work in Li *et al.*, [90] proposed an underwater image enhancement convolutional neural

network (CNN) model to enhance the quality of underwater image and video inspired by underwater scene prior.

Other constraints of underwater optical imaging are low contrast and brightness, wavelength absorption, attenuation and non-uniform light, colour distortion, suspended particles or plenty of marine life. Wavelength absorption can affect the colour performance which reduces the colour of the image where the effect is related with the geography of seawater because different water salinity will cause different wavelength absorption coefficients.

The flickering effects when sunshine day can cause strong highlights of image in the shallow ocean [68]. Capturing and observing colour in water face huge problems due to inconsistent attenuation of light across the visible spectrum. Observing colour activities are important for marine studies regarding identification of the species in water. Besides that, the activities are also important for monitoring and surveillance. Another effect is optical backscatter which leads to inaccuracy of the spectral information [86].

To overcome those problems, improvements have been done in hardware, software and algorithms. The underwater optical imaging system can be modelled and simulated based on attenuation data which can lead to a result of imaging distances, forward scatter (image blur), backward light scatter. The backward scatter can reduce the contrast of underwater images by generating a veiling glow. Object identification also can be located to improve the quality of the images produced [64]. A discovery on the limitations of both range and contrast of objects through the water needs to be expanded.

3.3 Underwater LiDAR

Light Detection and Ranging (LiDAR) is one of the advanced technologies for remote sensing that has been widely used for topographic mapping operations. Apart from that, it is also used in hydrographic surveying and the measurements of water depth in the bathymetric mapping operations especially for shallow water levels where the current technology SONAR is less efficient. It is reported that the penetration depth of bathymetric LiDAR can reach up to 50 m depending on water clarity [91]. One of the main advantages of LiDAR is its ability to provide 3D data collection in large volumes with high accuracy [92]. In addition to that, this technology has proven to be faster and cheaper options for shallow water surveying Gary & Jeff [93]. The history of LiDAR begins with the invention of Laser in the 1960s but the progress of LiDAR has been hindered due to the limitation in the accurate positioning system and inertial measurement units. Recently, there has been tremendous progress in Lidar technology with the advancement of high-speed electronics, computer technology, laser miniaturization technology and satellite based global navigation system. Apart from the device and system technology challenges, water turbidity is one of the main issues. There are two categories of LiDAR for underwater applications, namely airborne and subsea LiDAR. Historically, airborne LiDAR has been used since the 1960s in airborne laser bathymetry (ALB) mainly to detect submarines, but subsea LiDAR is still in its infancy [91].

3.3.1 Airborne LiDAR bathymetry

Airborne LiDAR bathymetry (ALB) is an active remote sensing technology for deriving underwater topography by detecting surface and bottom signals with a scanning green channel (532 nm) laser [94]. Similar to topographic LiDAR, in airborne LiDAR bathymetry, the laser transmitters and receivers are typically mounted below a fixed wing aircraft of a helicopter. Unlike topographic LiDAR that uses infra-red (IR) sources, bathymetric LiDAR systems are normally multispectral. In two wavelength

systems, IR radiation 1064 nm and green radiation 532 nm are employed to measure the depth of the water. Green wavelength is used since the attenuation at this wavelength is the least in an underwater environment. The infrared light is reflected to the aircraft from the water surface, while the additional green laser travels through the water column and is reflected by the seabed towards the transceiver. The depth of the seabed can be determined from the time difference between both reflected light. Due to the high attenuation in water, the depth that can be measured is limited to 25-70 m depending on the turbidity of water [92].

During the scanning process, successive laser pulses are emitted sequentially across the scanned surface which provides a coverage of a scanned area (swath) of the sea surface and seabed as shown in Figure 9. The resultant swaths are large since the LiDAR is located way above the water surface. Normally the height of the aircraft is around 300m with a swath of 100-250m.

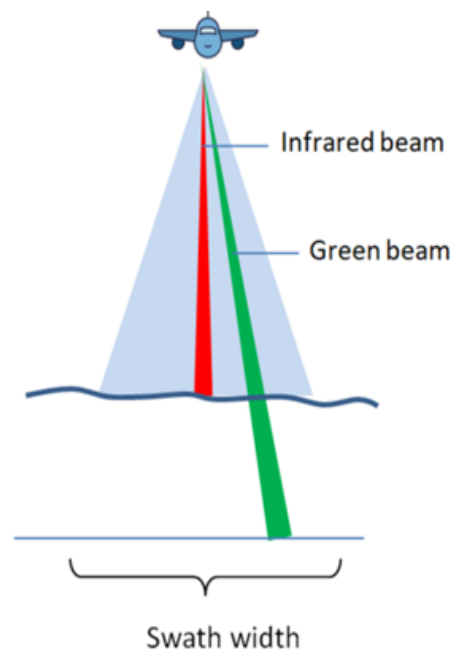

Fig. 9. The concept of airborne LiDAR

In the design of a LiDAR System, the trade-off between depth penetration and resolution must be considered. The power of the laser transmitter is a fundamental issue in lidar design. Simplistically, the greater the power, the greater the penetration depth will be. However, power is limited by several considerations, probably the most significant being eye safety. Generally, there are four major components for bathymetric LiDAR sensors namely, the laser scanner, the sensor, the GPS receiver and IMU. The LiDAR transceiver is used for transmitting and directing the laser pulses onto the water surface, for detecting/measuring the optical pulses returning from the surface/bottom, and for determining their absolute time-of-flight. The positioning system is responsible for obtaining the absolute position and attitude of the aircraft.

The data acquisition/control/display subsystem controls and coordinates information from all other components of the airborne systems, records all relevant data and system information onto a removable medium for later processing, and provides man-machine interfaces between the airborne system, its operator and the aircraft pilot. The ground-based processing subsystem is used for off-line processing of ALB data, including the transformation of raw ALB sounding information through to a fully verified XYZ digital database of soundings suitable for further analysis and interpretation by the end-user.

3.3.2 Subsea LiDAR

In subsea or underwater LiDAR, the LiDAR systems can be deployed at the sea surface on floating platforms or integrated to the underwater vehicles such as autonomous underwater vehicles (AUVs) or remotely operated vehicles (ROVs) as shown in Figure 10. Compared to airborne LiDAR where at least two wavelengths are used, subsea LiDAR uses only one wavelength typically in the blue green spectrum (~532 nm) as the attenuation of light is minimum at this spectrum. The advantages of subsea LiDAR compared to airborne LiDAR are higher resolution and accuracy (on the cm scale) [5]. Generally, the use of subsea LiDAR is limited to asset inspection such as in the oil and gas industry and metrology

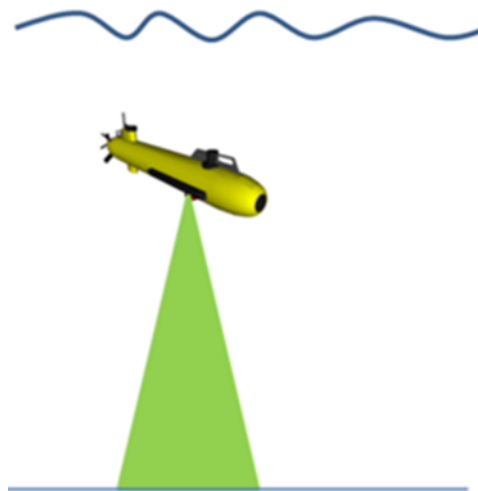

Fig. 10. The concept of subsea LiDAR

Various companies have ventured into developing underwater LiDAR systems. For example, 3DAAtDepth successfully designed an underwater LiDAR system that has a range precision of 6 mm and an angular resolution of less than 0.025 degree [95]. However, the maximum range is limited to 45 m.

Fugro has developed two mounting options based on the water depth. For shallow water which is less than 30 m depth, the LiDAR system can be mounted on a tripod. This technique enables 360 degree scan coverage. On the other hand, for deep water up to 3000 m, the system can be mounted on ROV and only capable of 180 scan coverage. Recently Fugro in partnership with Arete Associates has developed a multibeam LiDAR system known as RAMMS (Rapid Airborne Multibeam Mapping System). This system can reach a depth of 42 m [5].

3.3.3 Types or ranging

There are three types of ranging methods namely triangulation method, time of flight (ToF) and phase shift. TOF measurements have the same principle as acoustic/sonar systems [96]. In TOF, a short and intense pulse of laser radiation is emitted from the source to the target being measured. The time taken by the pulse to be reflected to the scanner is measured. To ensure all the light is reflected from a single target, a collimated light from a laser source is preferred. Figure 11 shows the principle of the TOF method. Since the speed of light is known, the object distance can be calculated as in Gordon & Charles[92].

$$R = \frac{vt}{2}$$

(1)

where v is the speed of light and t is the time taken by the pulse to be reflected.

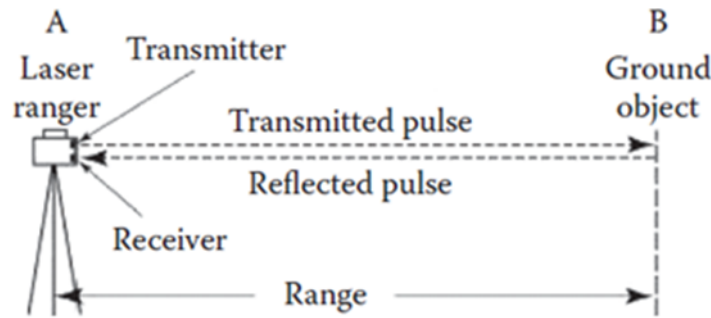

Fig. 11. The principle of TOF method [92]

The second method, the triangulation method, is similar to stereo camera approaches where the beam hits the target at a specific angle and then reflected towards the sensor for measuring the depth as shown in Figure 12. The distance can be estimated from the angles of at least two rays intersecting a certain point on an object. Even though this method is good for spatial and range resolution at short range, the errors in depth measurement grow exponentially with range.

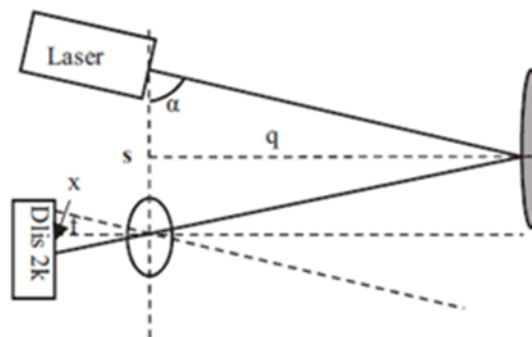

Fig. 12. Triangulation method [5]

The third method is called phase shift which is based on the phase difference measurement between the reflected signal and the incident signal as shown in Figure 13. Compared to the former method where light pulse is used, this method uses a continuous wave (CW) with amplitude modulation. Very few LiDAR systems are based on this technique as the availability of high-power CW laser is limited. This technique is also suitable for short range ($< 100\text{m}$). The range resolution is directly proportional to the phase difference resolution and the frequency of the signal. The resolution is higher when the frequency is higher as the minimum range interval that can be measured is reduced.

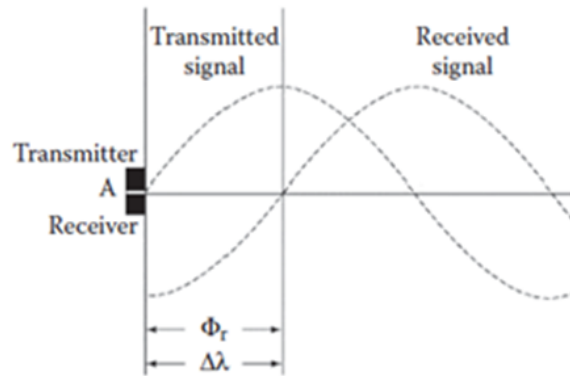

Fig. 13. The phase comparison between transmitted and received signals [92]

Eventhough various LiDAR systems are based on specific type of measurement method, some systems combine two measurement types such as Callidus CPW 8800 scanner. In this system, apart from using the TOF method, the pulses are also modulated with a high frequency signal that enable the phase difference between the transmitted and received signal to be measured. This allows a high precision up to ± 2 mm at a range of 30 m.

Triangulation method has a higher depth resolution (~ 5 mm) compared to the TOF method (\sim cm) [96]. It is reported that the depth resolution errors would approach 10 cm at 10 m range [5]. Unlike triangulation methods, the depth resolution of TOF and phase method does not depend on the scan distance but depends on the time or phase measurement [96]. Typically TOF and phase measurement methods can measure longer distances with maximum ranges from 50 m to 100 m. Due to this, most underwater LiDAR systems prefer to use a system based on TOF due to the longer distance and opt for a triangulation based system for shorter range operation.

The performance of a TOF based lidar system depends on the ability of the sensors to detect reflected signals. The TOF method is also better than the phase shift method in terms of the noise effect. In the phase shift method, additional noise is generated from the continuous backscatter from the entire water path. This does not occur in the TOF method as the back scatter detected by the receiver only comes from the water at the location of the pulse at a specific duration of time [5].

4. Comparison Between Acoustic and Optical Method

The main differences between acoustic and optical approaches are summarized in Table 3. Acoustic approach uses sound wave as the carrier signal to perform surveying and scanning activities while optical approach uses light wave from laser light source to perform the similar tasks. For a surveying task, a review in Chemisky *et al.*, [97] claimed optical surveying offers much better precision and resolution performance, incomparable to acoustic systems in very large-scale surveying.

Nevertheless, acoustic and optical approaches seem to complement each other as the optical is suitable to be used in clear shallow water and prone, to water turbidity due to the attenuation of light waves. In contrast, acoustic approach is robust against water turbidity and capable of operating at a longer range, but it has the physical constraint due to the resolution capability.

In comparison, sonar (acoustics signal) and laser (optical signal) technologies have complimentary features. The wide beam used in sonar causes poor directional resolution and consequently affects the quality of the obtained images and elements that the operator wants to interpret [19]. On the other hand, the laser method does not have any physical constraint to capture details of underwater assets that are unobtainable using sonar.

Table 3
 Comparison Between Acoustic and Optical Method

Parameter	Acoustic	Optical
Carrier signal	Using sound wave	Using light wave
Water environment	Deep water	Clear shallow water
System size	Large	Small
Robustness	Robustness to water turbidity	Prone to water turbidity
Resolution	Limited resolution	High resolution
Operating Frequency	between 1 kHz and 100 kHz.	10 – 150 MHz
Possible depth	A few meters to several kilometers.	Up to 100 meters in clear water

The choice of using either sonar or laser technologies is depending on the purpose of the application itself. For instance, long range sonar scans can be used to assess the general structure of an object which does not require levels of detail. Hence, sonar can accomplish this quickly and at low cost while laser scans of a large area can be time-consuming and costly. Further, it is also important to fully understand the environment of the scanned areas. As such, a high-resolution laser is suitable to scan the critical areas as it can provide the necessary information to ensure the continuous safety of operation while minimizing unnecessary maintenance expenses 2G Robotics Underwater Laser Scanner [98].

5. Advancement in Underwater High Precision Scanning

Significant breakthrough in underwater optical technology has led to the advancement of high precision underwater scanning (HPUS) systems. Figure 14 proposed the development of HPUS to capture high definition 3-dimensional data. HPUS employs an autonomous underwater vehicle (AUV) equipped with a 3D sensing system which is mounted on it. In comparison to submarines, AUV is preferred as it can perform missions in a safer way, at a lower cost and has been evaluated at full ocean depth up to 11 km [96,99]. The 3D sensing system integrates optical technology with acoustic waves (based on flexibility) to improve the accuracy of the AUV eyes. Sonar technology using acoustic waves operates at a much longer range (of up to some thousands of meters) and free from water turbidity. However, laser scanning (LIDAR) using visible light provides a much higher lateral resolution and refresh rate [100].

It is proposed that optical wireless communication (OWC) is used to communicate among devices within short range to improve the transmission speed and quality. Figure 14 shows the network architecture of the proposed HPUS system at which each device will communicate to the respective optical base station (OBS) and consequently creates an underwater local area network [101]. Hence, the captured signals from the HPUS system will be relayed from the OBS to the central OBS for further signal processing. The central OBS is the control center to process the captured signals using AI technology.

At this stage, artificial intelligence technology is to be incorporated to perform the underwater detection and classification. Recently, Han *et al.*, [102] proposed a convolutional neural network (CNN) method to improve the underwater vision prior to performing the underwater detection and classification using a deep CNN approach.

Finally, the processed signal can be transmitted to the onshore through satellite communication. In summary, HPUS system can be realized by incorporating the technologies of OWC, sonar, LiDAR, autonomous underwater vehicles, and artificial intelligence. However, an underwater power supply is another essential element to consider in order to power up the system.

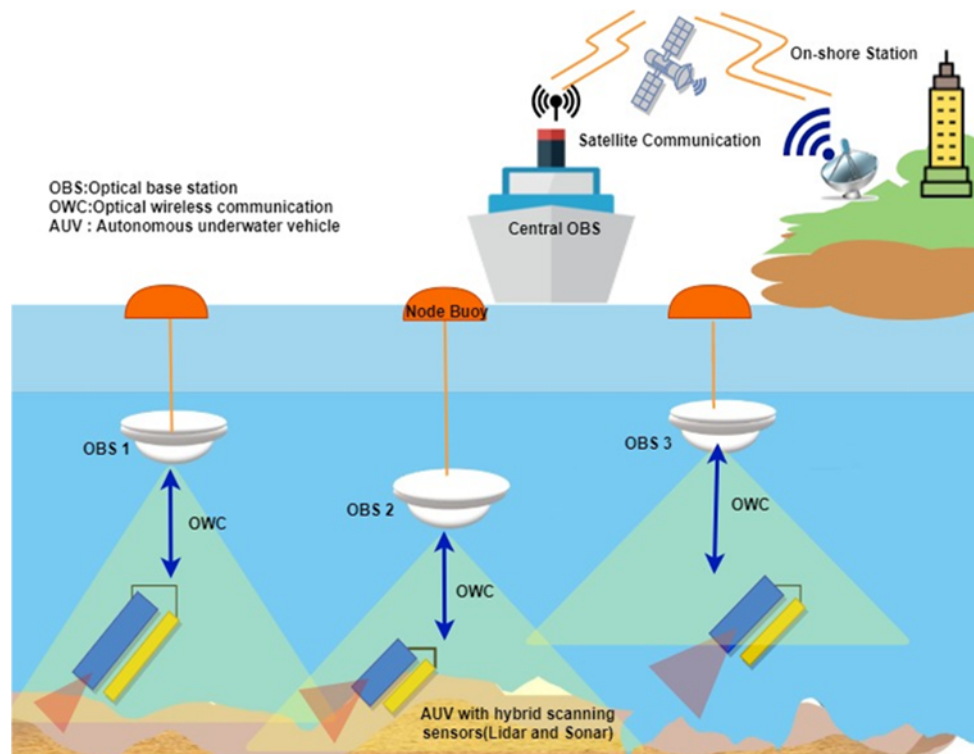

Fig. 14. Illustration of the proposed high precision underwater scanning (HPUS) systems

Underwater wireless power transfer (UWPT) has been identified as an important method to power underwater devices wirelessly [103]. UWPT is preferred as it eliminates the need for expensive cabling and fault-prone electrical connectors [104] and it can be accomplished through acoustic, optical or RF signals. Earlier work in Jun *et al.*, [105] used acoustic signals while recent works in Tamura *et al.*, [106] and [107] proposed capacitive and inductive UWPT respectively using RF signals. In the future, there is an attempt to develop hybrid modules focusing on optical-acoustic hybridization for powering.

6. Conclusions

This paper discusses various techniques used for underwater scanning and classifies those techniques into two types based on the signals used which are acoustics and optical signals. Various sensors using acoustics and optical signals respectively have been reviewed in terms of basic working principles, characters, the advantages, and disadvantages of these sensors. Then, the comparison between acoustics and optical approaches has been discussed and concluded that they always complement each other depending on the purpose of the underwater scanning. It is concluded that the dynamic and unstructured characteristics of underwater environments require sensors with a high resolution and accuracy. Therefore, this paper proposed a high-precision underwater scanning (HPUS) system which integrates the technologies of OWC, sonar, LiDAR, autonomous underwater vehicles and artificial intelligence. In the near future, it is believed that the advancement of scanning systems will grow more accurate and robust in line with the development of the aforementioned technologies.

Acknowledgments

The work was funded by UMT(UMT/TAPE-RG/2020/55219) and MOHE(FRGS/1/2019/TK04/USM/02/15).

References

- [1] Johnson, Laura J. "Optical property variability in the underwater optical wireless channel." PhD diss., University of Warwick, 2015.
- [2] Sun, Kai, Weicheng Cui, and Chi Chen. "Review of underwater sensing technologies and applications." *Sensors* 21, no. 23 (2021): 7849. [https://doi: 10.3390/s21237849](https://doi.org/10.3390/s21237849)
- [3] Rumbaugh, Luke K., Kaitlin J. Dunn, Erik M. Bollt, Brandon Cochenour, and William D. Jemison. "An underwater chaotic lidar sensor based on synchronized blue laser diodes." In *Ocean Sensing and Monitoring VIII*, vol. 9827, pp. 128-138. SPIE, 2016. [https://doi: 10.1117/12.2224498](https://doi.org/10.1117/12.2224498)
- [4] S. Chi, Z. Xie, and W. Chen, "A Laser Line auto-scanning system for underwater 3D reconstruction," *Sensors (Switzerland)*, vol. 16, no. 9, Sep. 2016. [https://doi: 10.3390/s16091534](https://doi.org/10.3390/s16091534)
- [5] Filisetti, Andrew, Andreas Marouchos, Andrew Martini, Tara Martin, and Simon Collings. "Developments and applications of underwater LiDAR systems in support of marine science." In *OCEANS 2018 MTS/IEEE Charleston*, pp. 1-10. IEEE, 2018. [https://doi: 10.1109/OCEANS.2018.8604547](https://doi.org/10.1109/OCEANS.2018.8604547)
- [6] Wawrzyniak, Natalia, and Grzegorz Zaniewicz. "Detecting small moving underwater objects using scanning sonar in waterside surveillance and complex security solutions." In *2016 17th International Radar Symposium (IRS)*, pp. 1-5. IEEE, 2016. [https://doi: 10.1109/IRS.2016.7497285](https://doi.org/10.1109/IRS.2016.7497285)
- [7] Dobson, Christian. "Introducing Sonar Technology as a Tool for Underwater Cave Surveying." BCRA Cave Radio & Electronics Group (2016).
- [8] Soares, Eduardo Elael de Melo. "Underwater simulation and mapping using imaging sonar through ray theory and Hilbert maps." Universidade Federal do Rio de Janeiro, 2017.
- [9] Paull, Liam, Sajad Saeedi, Mae Seto, and Howard Li. "AUV navigation and localization: A review." *IEEE Journal of oceanic engineering* 39, no. 1 (2013): 131-149. [https://doi: 10.1109/JOE.2013.2278891](https://doi.org/10.1109/JOE.2013.2278891)
- [10] Fairfield, Nathaniel, George Kantor, and David Wettergreen. "Real-time SLAM with octree evidence grids for exploration in underwater tunnels." *Journal of Field Robotics* 24, no. 1-2 (2007): 03-21. [https://doi: 10.1002/rob.20165](https://doi.org/10.1002/rob.20165)
- [11] Fairfield, Nathaniel, George Kantor, Dominic Jonak, and David Wettergreen. "Autonomous exploration and mapping of flooded sinkholes." *The International Journal of Robotics Research* 29, no. 6 (2010): 748-774. [https://doi: 10.1177/0278364909344779](https://doi.org/10.1177/0278364909344779)
- [12] Barkby, Stephen, Stefan B. Williams, Oscar Pizarro, and Michael V. Jakuba. "A featureless approach to efficient bathymetric SLAM using distributed particle mapping." *Journal of Field Robotics* 28, no. 1 (2011): 19-39. [https://doi: 10.1002/rob.20382](https://doi.org/10.1002/rob.20382)
- [13] Barkby, Stephen, Stefan B. Williams, Oscar Pizarro, and Michael V. Jakuba. "Bathymetric particle filter SLAM using trajectory maps." *The International Journal of Robotics Research* 31, no. 12 (2012): 1409-1430. [https://doi: 10.1177/0278364912459666](https://doi.org/10.1177/0278364912459666)
- [14] Aulinas, Josep, Amir Fazlollahi, Joaquim Salvi, Xavier Lladó, Y. Petillot, Jamil Sawas, and Rafael Garcia. "Robust automatic landmark detection for underwater SLAM using side-scan sonar imaging." In *Proceedings of the 11th International Conference on Mobile Robots and Competitions*, pp. 21-26. 2011.
- [15] Jaulin, Luc. "A nonlinear set membership approach for the localization and map building of underwater robots." *IEEE Transactions on Robotics* 25, no. 1 (2009): 88-98. [https://doi: 10.1109/TRO.2008.2010358](https://doi.org/10.1109/TRO.2008.2010358)
- [16] Hernández, Emili, Pere Ridao, David Ribas, and Angelos Mallios. "Probabilistic sonar scan matching for an AUV." In *2009 IEEE/RSJ International Conference on Intelligent Robots and Systems*, pp. 255-260. IEEE, 2009. [https://doi: 10.1109/IROS.2009.5354656](https://doi.org/10.1109/IROS.2009.5354656)
- [17] Mallios, Angelos, Pere Ridao, David Ribas, and Emili Hernandez. "Probabilistic sonar scan matching SLAM for underwater environment." In *OCEANS'10 IEEE SYDNEY*, pp. 1-8. IEEE, 2010. [https://doi: 10.1109/OCEANSSYD.2010.5603650](https://doi.org/10.1109/OCEANSSYD.2010.5603650)
- [18] Johannsson, Hordur, Michael Kaess, Brendan Englot, Franz Hover, and John Leonard. "Imaging sonar-aided navigation for autonomous underwater harbor surveillance." In *2010 IEEE/RSJ International Conference on Intelligent Robots and Systems*, pp. 4396-4403. IEEE, 2010. [https://doi: 10.1109/IROS.2010.5650831](https://doi.org/10.1109/IROS.2010.5650831)
- [19] Blake Bright, Matt Curl, and Michael Elswick, "Sonar and the Uses in Mobile Robots," 2018.
- [20] Parnum, Iain, Justy Siwabessy, Alexander Gavrilov, and Miles Parsons. "A comparison of single beam and multibeam sonar systems in seafloor habitat mapping." In *Proc. 3rd Int. Conf. and Exhibition of Underwater Acoustic Measurements: Technologies & Results*, Nafplion, Greece, pp. 155-162. 2009.

- [21] Lurton, Xavier, Geoffroy Lamarche, Craig Brown, V. L. Lucieer, Glen Rice, Alexandre Schimel, and Tom Weber. "Backscatter measurements by seafloor-mapping sonars: guidelines and recommendations." A collective report by members of the GeoHab Backscatter Working Group May (2015): 1-200.
- [22] Hao, Haoqi, Tiejian Xia, and Min Xie. "Design of an underwater acoustic array for full ocean depth multi-beam echo sounder." In *MATEC Web of Conferences*, vol. 283, p. 05002. EDP Sciences, 2019. [https://doi: 10.1051/mateconf/2019](https://doi.org/10.1051/mateconf/2019).
- [23] Padial, Jose, Shandor G. Dektor, and Stephen M. Rock. "Correlation of sidescan sonar acoustic shadows and bathymetry for terrain-relative navigation." *Unmanned Untethered Submersible Technology* (2013).
- [24] Reed, S., Y. Petilot, and J. Bell. "A model based approach to mine detection and classification in sidescan sonar." In *Oceans 2003. Celebrating the Past... Teaming Toward the Future (IEEE Cat. No. 03CH37492)*, vol. 3, pp. 1402-1407. IEEE, 2003. [https://doi: 10.1109/OCEANS.2003.178066](https://doi.org/10.1109/OCEANS.2003.178066)
- [25] Burguera, Antoni, and Gabriel Oliver. "High-resolution underwater mapping using side-scan sonar." *PloS one* 11, no. 1 (2016): e0146396. [https://doi: 10.1371/journal.pone.0146396](https://doi.org/10.1371/journal.pone.0146396)
- [26] Petrich, Jan, Mark F. Brown, Jesse L. Pentzer, and John P. Sustersic. "Side scan sonar based self-localization for small Autonomous Underwater Vehicles." *Ocean Engineering* 161 (2018): 221-226. [https://doi: 10.1016/j.oceaneng.2018.04.095](https://doi.org/10.1016/j.oceaneng.2018.04.095)
- [27] Chang, Yet-Chung, Shu-Kun Hsu, and Ching-Hui Tsai. "Sidescan sonar image processing: correcting brightness variation and patching gaps." *Journal of marine science and Technology* 18, no. 6 (2010): 1.
- [28] Galdran, Adrian, Alberto Isasi, Mohammed Al-Rawi, Jonathan Rodriguez, Joaquim Bastos, Fredrik Elmgren, and Marc Pinto. "An efficient non-uniformity correction technique for side-scan sonar imagery." In *OCEANS 2017-Aberdeen*, pp. 1-6. IEEE, 2017. [https://doi: 10.1109/OCEANSE.2017.8084577](https://doi.org/10.1109/OCEANSE.2017.8084577)
- [29] Shang, Xiaodong, Jianhu Zhao, Hongmei Zhang, Aixue Wang, and Xiao Wang. "Integration of SSS-based Reconstructed Results and Bathymetric Data to Obtain High-resolution and High-accuracy Underwater Topography." *IEEE Geoscience and Remote Sensing Letters* 19 (2022): 1-5. [https://doi: 10.1109/LGRS.2022.3174863](https://doi.org/10.1109/LGRS.2022.3174863).
- [30] González, Yolanda, Gabriel Oliver, and Antoni Burguera. "Underwater scan matching using a mechanical scanned imaging sonar." *IFAC Proceedings Volumes* 43, no. 16 (2010): 377-382. [https://doi: 10.3182/20100906-3-it-2019.00066](https://doi.org/10.3182/20100906-3-it-2019.00066)
- [31] Ribas, David, Pere Ridaó, José Neira, David Ribas, Pere Ridaó, and José Neira. "Understanding mechanically scanned imaging sonars." *Underwater SLAM for Structured Environments Using an Imaging Sonar* (2010): 37-46. [https://doi: 10.1007/978-3-642-14040-2_4](https://doi.org/10.1007/978-3-642-14040-2_4)
- [32] Ribas Romagós, David, Pere Ridaó Rodríguez, José Neira Parra, and Juan Domingo Tardós. "Line Extraction from Mechanically Scanned Imaging Sonar." © Martí J., Benedí JM, Mendonça AM, Serrat J.(eds). *Pattern Recognition and Image Analysis: IbPRIA 2007.(Lecture Notes in Computer Science, vol. 4477)* (2007). [https://doi: 10.1007/978-3-540-72847-4_42](https://doi.org/10.1007/978-3-540-72847-4_42).
- [33] Hernández Bes, Emili, Pere Ridaó Rodríguez, David Ribas Romagós, and Joan Batlle i Grabulosa. "MSISpIC: A probabilistic scan matching algorithm using a mechanical scanned imaging sonar." *Journal of physical agents*, 2009, vol. 3, núm. 1, p. 3-11 (2009).
- [34] Chen, Ling, Aolei Yang, Huosheng Hu, and Wasif Naeem. "RBPF-MSIS: Toward rao-blackwellized particle filter SLAM for autonomous underwater vehicle with slow mechanical scanning imaging sonar." *IEEE Systems Journal* 14, no. 3 (2019): 3301-3312. [https://doi: 10.1109/JSYST.2019.2938599](https://doi.org/10.1109/JSYST.2019.2938599).
- [35] Zandara, Simone, Pere Ridaó, David Ribas, Angelos Mallios, and Albert Palomer. "Probabilistic surface matching for bathymetry based SLAM." In *2013 IEEE International Conference on Robotics and Automation*, pp. 40-45. IEEE, 2013. [https://doi: 10.1109/ICRA.2013.6630554](https://doi.org/10.1109/ICRA.2013.6630554)
- [36] Sung, Minsung, Hyeonwoo Cho, Taesik Kim, Hangil Joe, and Son-Cheol Yu. "Crosstalk removal in forward scan sonar image using deep learning for object detection." *IEEE Sensors Journal* 19, no. 21 (2019): 9929-9944. [https://doi: 10.1109/JSEN.2019.2925830](https://doi.org/10.1109/JSEN.2019.2925830)
- [37] Pyo, Juhyun, Hyeonwoo Cho, Hangil Joe, Tamaki Ura, and Son-Cheol Yu. "Development of hovering type AUV "Cyclops" and its performance evaluation using image mosaicing." *Ocean Engineering* 109 (2015): 517-530. [https://doi: 10.1016/j.oceaneng.2015.09.023](https://doi.org/10.1016/j.oceaneng.2015.09.023)
- [38] Cho, Hyeonwoo, Jeonghwe Gu, and Son-Cheol Yu. "Robust sonar-based underwater object recognition against angle-of-view variation." *IEEE Sensors Journal* 16, no. 4 (2015): 1013-1025. [https://doi: 10.1109/JSEN.2015.2496945](https://doi.org/10.1109/JSEN.2015.2496945).
- [39] Stokey, Roger P., Alexander Roup, Chris von Alt, Ben Allen, Ned Forrester, Tom Austin, Rob Goldsborough et al. "Development of the REMUS 600 autonomous underwater vehicle." In *Proceedings of OCEANS 2005 MTS/IEEE*, pp. 1301-1304. IEEE, 2005. [https://doi: 10.1109/OCEANS.2005.1639934](https://doi.org/10.1109/OCEANS.2005.1639934)

- [40] Petillot, Yvan, I. Tena Ruiz, and David M. Lane. "Underwater vehicle obstacle avoidance and path planning using a multi-beam forward looking sonar." *IEEE journal of oceanic engineering* 26, no. 2 (2001): 240-251. [https://doi: 10.1109/48.922790](https://doi.org/10.1109/48.922790)
- [41] Aykin, Murat D., and Shahriar Negahdaripour. "Forward-look 2-D sonar image formation and 3-D reconstruction." In *2013 OCEANS-San Diego*, pp. 1-10. IEEE, 2013. [https://doi: 10.23919/OCEANS.2013.6741270](https://doi.org/10.23919/OCEANS.2013.6741270)
- [42] Galceran, Enric, Vladimir Djapic, Marc Carreras, and David P. Williams. "A real-time underwater object detection algorithm for multi-beam forward looking sonar." *IFAC Proceedings Volumes* 45, no. 5 (2012): 306-311. <https://doi.org/10.3182/20120410-3-PT-4028.00051>
- [43] Kim, Byeongjin, and Son-Cheol Yu. "Imaging sonar based real-time underwater object detection utilizing AdaBoost method." In *2017 IEEE Underwater Technology (UT)*, pp. 1-5. IEEE, 2017. [https://doi: 10.1109/UT.2017.7890300](https://doi.org/10.1109/UT.2017.7890300).
- [44] Assalih, Hassan. "3D reconstruction and motion estimation using forward looking sonar." PhD diss., Heriot-Watt University, 2013. [https://doi: 10.1007/978-3-642-33509-9_33](https://doi.org/10.1007/978-3-642-33509-9_33)
- [45] Xie, Shaorong, Jinbo Chen, Jun Luo, Pu Xie, and Wenbin Tang. "Detection and tracking of underwater object based on forward-scan sonar." In *Intelligent Robotics and Applications: 5th International Conference, ICIRA 2012, Montreal, QC, Canada, October 3-5, 2012, Proceedings, Part I 5*, pp. 341-347. Springer Berlin Heidelberg, 2012. [https://doi: 10.1007/978-3-642-33509-9_33](https://doi.org/10.1007/978-3-642-33509-9_33)
- [46] Pyo, Juhyun, Hyeonwoo Cho, and Son-Cheol Yu. "Beam slice-based recognition method for acoustic landmark with multi-beam forward looking sonar." *IEEE Sensors Journal* 17, no. 21 (2017): 7074-7085. [https://doi: 10.1109/JSEN.2017.2755547](https://doi.org/10.1109/JSEN.2017.2755547).
- [47] Tulsook, Siwakorn, Teerasit Kasetkasem, Yodyium Tipsuwan, Nobuhiko Sugino, Thitiporn Chanwimaluang, and Phakhachon Hoonsuwan. "A pipeline extraction on forward-looking sonar images using the self-organizing map." In *2018 15th International Conference on Electrical Engineering/Electronics, Computer, Telecommunications and Information Technology (ECTI-CON)*, pp. 584-587. IEEE, 2018. [https://doi: 10.1109/ECTICon.2018.8619973](https://doi.org/10.1109/ECTICon.2018.8619973)
- [48] Jin, Leilei, Hong Liang, and Changsheng Yang. "Accurate underwater ATR in forward-looking sonar imagery using deep convolutional neural networks." *IEEE Access* 7 (2019): 125522-125531. [https://doi: 10.1109/ACCESS.2019.2939005](https://doi.org/10.1109/ACCESS.2019.2939005)
- [49] Alom, Md Zahangir, Tarek M. Taha, Chris Yakopcic, Stefan Westberg, Paheding Sidike, Mst Shamima Nasrin, Mahmudul Hasan, Brian C. Van Essen, Abdul AS Awwal, and Vijayan K. Asari. "A state-of-the-art survey on deep learning theory and architectures." *electronics* 8, no. 3 (2019): 292. [https://doi: 10.3390/electronics8030292](https://doi.org/10.3390/electronics8030292)
- [50] Han, Fenglei, Jingzheng Yao, Haitao Zhu, and Chunhui Wang. "Underwater image processing and object detection based on deep CNN method." *Journal of Sensors* 2020 (2020). [https://doi: 10.1155/2020/6707328](https://doi.org/10.1155/2020/6707328)
- [51] Zeng, Zhaoquan, Shu Fu, Huihui Zhang, Yuhang Dong, and Julian Cheng. "A survey of underwater optical wireless communications." *IEEE communications surveys & tutorials* 19, no. 1 (2016): 204-238. [https://doi: 10.1109/COMST.2016.2618841](https://doi.org/10.1109/COMST.2016.2618841)
- [52] Barta, András, and Gábor Horváth. "Underwater binocular imaging of aerial objects versus the position of eyes relative to the flat water surface." *JOSA A* 20, no. 12 (2003): 2370-2377. [https://doi: 10.1364/JOSAA.20.002370](https://doi.org/10.1364/JOSAA.20.002370)
- [53] Flener, Claude, Eliisa Lotsari, Petteri Alho, and Jukka Käyhkö. "Comparison of empirical and theoretical remote sensing based bathymetry models in river environments." *River Research and Applications* 28, no. 1 (2012): 118-133. [https://doi: 10.1002/rra.1441](https://doi.org/10.1002/rra.1441)
- [54] Marcus, W. Andrew, and Mark A. Fonstad. "Optical remote mapping of rivers at sub-meter resolutions and watershed extents." *Earth Surface Processes and Landforms: The Journal of the British Geomorphological Research Group* 33, no. 1 (2008): 4-24. [https://doi: 10.1002/esp.1637](https://doi.org/10.1002/esp.1637)
- [55] Shintani, Christina, and Mark A. Fonstad. "Comparing remote-sensing techniques collecting bathymetric data from a gravel-bed river." *International journal of remote sensing* 38, no. 8-10 (2017): 2883-2902. [https://doi: 10.1080/01431161.2017.1280636](https://doi.org/10.1080/01431161.2017.1280636)
- [56] Huang, S. Y., C. L. Liu, and H. Ren. "COSTAL BATHYMETRY ESTIMATION FROM MULTISPECTRAL IMAGE WITH BACK PROPAGATION NEURAL NETWORK." *International Archives of the Photogrammetry, Remote Sensing & Spatial Information Sciences* 41 (2016). [https://doi: 10.5194/isprsarchives-XLI-B8-1123-2016](https://doi.org/10.5194/isprsarchives-XLI-B8-1123-2016)
- [57] Dierssen, Heidi M., Richard C. Zimmerman, Robert A. Leathers, T. Valerie Downes, and Curtiss O. Davis. "Ocean color remote sensing of seagrass and bathymetry in the Bahamas Banks by high-resolution airborne imagery." *Limnology and oceanography* 48, no. 1part2 (2003): 444-455. [https://doi: 10.4319/lo.2003.48.1_part_2.0444](https://doi.org/10.4319/lo.2003.48.1_part_2.0444).
- [58] Jordan, David C., and Mark A. Fonstad. "Two dimensional mapping of river bathymetry and power using aerial photography and GIS on the Brazos River, Texas." *Geocarto International* 20, no. 3 (2005): 13-20. [https://doi: 10.1080/10106040508542351](https://doi.org/10.1080/10106040508542351)

- [59] Kasvi, Elina, Jouni Salmela, E. Lotsari, T. Kumpula, and S. N. Lane. "Comparison of remote sensing based approaches for mapping bathymetry of shallow, clear water rivers." *Geomorphology* 333 (2019): 180-197. [https://doi: 10.1016/j.geomorph.2019.02.017](https://doi.org/10.1016/j.geomorph.2019.02.017)
- [60] Li, Chongyi, Jichang Guo, Shanji Chen, Yibin Tang, Yanwei Pang, and Jian Wang. "Underwater image restoration based on minimum information loss principle and optical properties of underwater imaging." In *2016 IEEE International Conference on Image Processing (ICIP)*, pp. 1993-1997. IEEE, 2016. [https://doi: 10.1109/ICIP.2016.7532707](https://doi.org/10.1109/ICIP.2016.7532707)
- [61] Jaffe, Jules S. "Underwater optical imaging: the past, the present, and the prospects." *IEEE Journal of Oceanic Engineering* 40, no. 3 (2014): 683-700. [https://doi: 10.1109/JOE.2014.2350751](https://doi.org/10.1109/JOE.2014.2350751).
- [62] Zhang, Weidong, Lili Dong, Xipeng Pan, Peiyu Zou, Li Qin, and Wenhai Xu. "A survey of restoration and enhancement for underwater images." *IEEE Access* 7 (2019): 182259-182279. [https://doi: 10.1109/ACCESS.2019.2959560](https://doi.org/10.1109/ACCESS.2019.2959560)
- [63] Bystrov, Aleksandr, Edward Hoare, Marina Gashinova, Mikhail Cherniakov, and Thuy-Yung Tran. "Underwater optical imaging for automotive wading." *Sensors* 18, no. 12 (2018): 4476. [https://doi: 10.3390/s18124476](https://doi.org/10.3390/s18124476).
- [64] Amer, Khadidja Ould, Marwa Elbouz, Ayman Alfalou, Christian Brosseau, and Jaouad Hajjami. "Enhancing underwater optical imaging by using a low-pass polarization filter." *Optics express* 27, no. 2 (2019): 621-643. [https://doi: 10.1364/OE.27.000621](https://doi.org/10.1364/OE.27.000621)
- [65] Chen, Bin, Rong Li, Wanjian Bai, Xun Zhang, Jianxiang Li, and Rui Guo. "Research on recognition method of optical detection image of underwater robot for submarine cable." In *2019 IEEE 3rd Advanced Information Management, Communicates, Electronic and Automation Control Conference (IMCEC)*, pp. 1973-1976. IEEE, 2019. [https://doi: 10.1109/IMCEC46724.2019.8984079](https://doi.org/10.1109/IMCEC46724.2019.8984079)
- [66] Yemelyanov, Konstantin M., Shih-Schön Lin, Edward N. Pugh Jr, and Nader Engheta. "Adaptive algorithms for two-channel polarization sensing under various polarization statistics with nonuniform distributions." *Applied optics* 45, no. 22 (2006): 5504-5520. [https://doi: 10.1364/AO.45.005504](https://doi.org/10.1364/AO.45.005504).
- [67] Schechner, Yoav Y., and Yuval Averbuch. "Regularized image recovery in scattering media." *IEEE Transactions on Pattern Analysis and Machine Intelligence* 29, no. 9 (2007): 1655-1660. [https://doi: 10.1109/TPAMI.2007.1141](https://doi.org/10.1109/TPAMI.2007.1141).
- [68] Lu, Huimin, Yujie Li, Yudong Zhang, Min Chen, Seiichi Serikawa, and Hyoungseop Kim. "Underwater optical image processing: a comprehensive review." *Mobile networks and applications* 22 (2017): 1204-1211. [https://doi: 10.1007/s11036-017-0863-4](https://doi.org/10.1007/s11036-017-0863-4).
- [69] Kocak, Donna M., Fraser R. Dalgleish, Frank M. Caimi, and Yoav Y. Schechner. "A focus on recent developments and trends in underwater imaging." *Marine Technology Society Journal* 42, no. 1 (2008): 52.
- [70] Jaffe, Jules S. "Enhanced extended range underwater imaging via structured illumination." *Optics express* 18, no. 12 (2010): 12328-12340. [https://doi: 10.1364/OE.18.012328](https://doi.org/10.1364/OE.18.012328).
- [71] Murez, Zak, Tali Treibitz, Ravi Ramamoorthi, and David Kriegman. "Photometric stereo in a scattering medium." In *Proceedings of the IEEE international conference on computer vision*, pp. 3415-3423. 2015. [https://doi: 10.1109/ICCV.2015.390](https://doi.org/10.1109/ICCV.2015.390).
- [72] Treibitz, Tali, and Yoav Y. Schechner. "Turbid scene enhancement using multi-directional illumination fusion." *IEEE Transactions on Image Processing* 21, no. 11 (2012): 4662-4667. [https://doi: 10.1109/TIP.2012.2208978](https://doi.org/10.1109/TIP.2012.2208978).
- [73] Roser, Martin, Matthew Dunbabin, and Andreas Geiger. "Simultaneous underwater visibility assessment, enhancement and improved stereo." In *2014 IEEE International Conference on Robotics and Automation (ICRA)*, pp. 3840-3847. IEEE, 2014. [https://doi: 10.1109/ICRA.2014.6907416](https://doi.org/10.1109/ICRA.2014.6907416).
- [74] Fattal, Raanan. "Dehazing using color-lines." *ACM transactions on graphics (TOG)* 34, no. 1 (2014): 1-14. [https://doi: 10.1145/2651362](https://doi.org/10.1145/2651362).
- [75] Lu, Huimin, Yujie Li, Lifeng Zhang, and Seiichi Serikawa. "Contrast enhancement for images in turbid water." *JOSA A* 32, no. 5 (2015): 886-893. [https://doi: 10.1364/JOSAA.32.000886](https://doi.org/10.1364/JOSAA.32.000886).
- [76] Chiang, John Y., and Ying-Ching Chen. "Underwater image enhancement by wavelength compensation and dehazing." *IEEE transactions on image processing* 21, no. 4 (2011): 1756-1769. [https://doi: 10.1109/TIP.2011.2179666](https://doi.org/10.1109/TIP.2011.2179666).
- [77] He, Kaiming, Jian Sun, and Xiaoou Tang. "Single image haze removal using dark channel prior." *IEEE transactions on pattern analysis and machine intelligence* 33, no. 12 (2010): 2341-2353. [https://doi: 10.1109/TPAMI.2010.168](https://doi.org/10.1109/TPAMI.2010.168).
- [78] Ancuti, Cosmin, Codruta Orniana Ancuti, Tom Haber, and Philippe Bekaert. "Enhancing underwater images and videos by fusion." In *2012 IEEE conference on computer vision and pattern recognition*, pp. 81-88. IEEE, 2012. [https://doi: 10.1109/CVPR.2012.6247661](https://doi.org/10.1109/CVPR.2012.6247661).
- [79] Galdran, Adrian, David Pardo, Artzai Picón, and Aitor Alvarez-Gila. "Automatic red-channel underwater image restoration." *Journal of Visual Communication and Image Representation* 26 (2015): 132-145. [https://doi: 10.1016/j.jvcir.2014.11.006](https://doi.org/10.1016/j.jvcir.2014.11.006).

- [80] Gibson, Kristofor B. "Preliminary results in using a joint contrast enhancement and turbulence mitigation method for underwater optical imaging." In *OCEANS 2015-MTS/IEEE Washington*, pp. 1-5. IEEE, 2015. <https://doi:10.23919/OCEANS.2015.7404514>.
- [81] Serikawa, Seiichi, and Huimin Lu. "Underwater image dehazing using joint trilateral filter." *Computers & Electrical Engineering* 40, no. 1 (2014): 41-50. <https://doi:10.1016/j.compeleceng.2013.10.016>.
- [82] Iqbal, Kashif, Rosalina Abdul Salam, Azam Osman, and Abdullah Zawawi Talib. "Underwater Image Enhancement Using an Integrated Colour Model." *IAENG International Journal of computer science* 34, no. 2 (2007).
- [83] Torres-Méndez, Luz A., and Gregory Dudek. "Color correction of underwater images for aquatic robot inspection." In *Energy Minimization Methods in Computer Vision and Pattern Recognition: 5th International Workshop, EMMCVPR 2005, St. Augustine, FL, USA, November 9-11, 2005. Proceedings 5*, pp. 60-73. Springer Berlin Heidelberg, 2005. https://doi:10.1007/11585978_5
- [84] Åhlén, Julia, David Sundgren, and Ewert Bengtsson. "Application of underwater hyperspectral data for color correction purposes." *Pattern Recognition and Image Analysis* 17, no. 1 (2007): 170. <https://doi:10.1134/S105466180701021X>.
- [85] Jaffe, Jules S. "A historical perspective on underwater optical imaging." In *2013 MTS/IEEE OCEANS-Bergen*, pp. 1-3. IEEE, 2013. <https://doi:10.1109/OCEANS-Bergen.2013.6608121>.
- [86] Mortazavi, Halleh, John P. Oakley, and Braham Barkat. "Mitigating the effect of optical back-scatter in multispectral underwater imaging." *Measurement Science and Technology* 24, no. 7 (2013): 074025. <https://doi:10.1088/0957-0233/24/7/074025>.
- [87] Roston, J., C. Bradley, and J. R. Cooperstock. "Underwater window: high definition video on VENUS and NEPTUNE." In *OCEANS 2007*, pp. 1-8. IEEE, 2007. <https://doi:10.1109/OCEANS.2007.4449327>.
- [88] Lam, Katherine, Robin S. Bradbeer, Paul KS Shin, Kenneth KK Ku, and Paul Hodgson. "Application of a real-time underwater surveillance camera in monitoring of fish assemblages on a shallow coral communities in a marine park." In *OCEANS 2007*, pp. 1-7. IEEE, 2007. <https://doi:10.1109/OCEANS.2007.4449240>.
- [89] Hou, Weilin Will. "A simple underwater imaging model." *Optics letters* 34, no. 17 (2009): 2688-2690. <https://doi:10.1364/OL.34.002688>.
- [90] Li, Chongyi, Saeed Anwar, and Fatih Porikli. "Underwater scene prior inspired deep underwater image and video enhancement." *Pattern Recognition* 98 (2020): 107038. <https://doi:10.1016/j.patcog.2019.107038>.
- [91] Cunningham, A. Grant, W. J. Lillycrop, Gary C. Guenther, and Mark W. Brooks. *Shallow water laser bathymetry: accomplishments and applications*. US Army Corps of Engineers Mobile United States, 2016.
- [92] Gordon Petrie and Charles K. Toth, *Topographic Laser Ranging and Scanning*. Second edition. | Boca Raton : Taylor & Francis, CRC Press, 2018.: CRC Press, 2018. doi: 10.1201/9781315154381.
- [93] Guenther, Gary C., W. Jeff Lillycrop, and John R. Banic. "Future advancements in airborne hydrography." *The International Hydrographic Review* (2002).
- [94] Yang, Fanlin, Chao Qi, Dianpeng Su, Shijun Ding, Yan He, and Yue Ma. "An airborne LiDAR bathymetric waveform decomposition method in very shallow water: A case study around Yuanzhi Island in the South China Sea." *International Journal of Applied Earth Observation and Geoinformation* 109 (2022): 102788. <https://doi:10.1016/j.jag.2022.102788>
- [95] Zwetsloot, Eva, and Lynrick Wix. "Design of a deep sea LiDAR system: Laser Pulse transmission." (2019).
- [96] Castillón, Miguel, Albert Palomer, Josep Forest, and Pere Ridao. "State of the art of underwater active optical 3D scanners." *Sensors* 19, no. 23 (2019): 5161. <https://doi:10.3390/s19235161>.
- [97] Chemisky, Bertrand, Fabio Menna, Erica Nocerino, and Pierre Drap. "Underwater survey for oil and gas industry: A review of close range optical methods." *Remote Sensing* 13, no. 14 (2021): 2789. <https://doi:10.3390/rs13142789>.
- [98] 2G Robotics Underwater Laser Scanner, "Sonar vs. Laser," n.d. <https://paperzz.com/doc/8927629/sonar-vs.-laser>.
- [99] Garcia, Rafael, Nuno Gracias, Tudor Nicosevici, Ricard Prados, Natalia Hurtos, Ricard Campos, Javier Escartin, Armagan Elibol, Ramon Hegedus, and Laszlo Neumann. "Exploring the seafloor with underwater robots." *Computer Vision in Vehicle Technology: Land, Sea & Air* (2017): 75-99. <https://doi:10.1002/9781118868065.ch4>.
- [100] Massot-Campos, Miquel, and Gabriel Oliver-Codina. "Optical sensors and methods for underwater 3D reconstruction." *Sensors* 15, no. 12 (2015): 31525-31557. <https://doi:10.3390/s151229864>.
- [101] Saeed, Nasir, Abdulkadir Celik, Tareq Y. Al-Naffouri, and Mohamed-Slim Alouini. "Underwater optical wireless communications, networking, and localization: A survey." *Ad Hoc Networks* 94 (2019): 101935. <https://doi:10.1016/j.adhoc.2019.101935>.
- [102] Han, Fenglei, Jingzheng Yao, Haitao Zhu, and Chunhui Wang. "Underwater image processing and object detection based on deep CNN method." *Journal of Sensors* 2020 (2020). <https://doi:10.1155/2020/6707328>.

- [103] Ogihara, Makoto, Tadashi Ebihara, Koichi Mizutani, and Naoto Wakatsuki. "Wireless power and data transfer system for station-based autonomous underwater vehicles." In *OCEANS 2015-MTS/IEEE Washington*, pp. 1-5. IEEE, 2015. [https://doi: 10.23919/OCEANS.2015.7404400](https://doi.org/10.23919/OCEANS.2015.7404400).
- [104] Hayslett, Tyler M., Taofeek Orekan, and Peng Zhang. "Underwater wireless power transfer for ocean system applications." In *OCEANS 2016 MTS/IEEE Monterey*, pp. 1-6. IEEE, 2016. [https://doi: 10.1109/OCEANS.2016.7761481](https://doi.org/10.1109/OCEANS.2016.7761481).
- [105] Jun, Han, Akira Asada, Tamaki Ura, Yasunobu Yagita, and Yukinaga Yamauchi. "High speed acoustic network and noncontact power supplier for seafloor geodetic observing robot system." In *OCEANS 2006-Asia Pacific*, pp. 1-3. IEEE, 2006. [https://doi: 10.1109/OCEANSAP.2006.4393881](https://doi.org/10.1109/OCEANSAP.2006.4393881).
- [106] Tamura, Masaya, Yasumasa Naka, Kousuke Murai, and Takuma Nakata. "Design of a capacitive wireless power transfer system for operation in fresh water." *IEEE Transactions on Microwave Theory and Techniques* 66, no. 12 (2018): 5873-5884. [https://doi: 10.1109/TMTT.2018.2875960](https://doi.org/10.1109/TMTT.2018.2875960).
- [107] Hughes, H., and L. A. Gish. "Inductive recharging for a small commercial autonomous underwater vehicle." In *OCEANS 2017-Anchorage*, pp. 1-8. IEEE, 2017.