



## Journal of Advanced Research in Applied Mechanics

Journal homepage:  
[https://semarakilmu.com.my/journals/index.php/appl\\_mech/index](https://semarakilmu.com.my/journals/index.php/appl_mech/index)  
ISSN: 2289-7895



# Development Home Automation and Safety Circuit Breaker with Esp8266 Microcontroller

Nur Azura Noor Azhuan<sup>1,\*</sup>, Brandon James<sup>1</sup>, Adam Samsudin<sup>1</sup>, Nor Hafizah Hussin<sup>2</sup>, Rahaini Mohd Said<sup>2</sup>, Siti Haryanti Hj Hairol Anuar<sup>2</sup>, Norshaza Atika Saidin<sup>3</sup>, Mohd Syafiq Abd Aziz<sup>4,5</sup>

<sup>1</sup> Faculty of Electrical Technology and Engineering (FTKE), Universiti Teknikal Melaka Malaysia, Malaysia

<sup>2</sup> Faculty of Electronics & Computer Technology and Engineering (FTKEK), Universiti Teknikal Melaka Malaysia, Malaysia

<sup>3</sup> Institut Matematik Kejuruteraan (IMK), Universiti Malaysia Perlis (UniMAP), Kampus Pauh Putra, 02600 Arau, Perlis, Malaysia

<sup>4</sup> Faculty Of Mechanical Technology and Engineering (FTKM), Universiti Teknikal Malaysia Melaka, Malaysia

<sup>5</sup> Tribology Group, Department of Mechanical Engineering, Imperial College London, South Kensington Campus, SW7 2AZ London, United Kingdom

### ARTICLE INFO

#### Article history:

Received 30 March 2024

Received in revised form 25 May 2024

Accepted 8 June 2024

Available online 30 June 2024

#### Keywords:

Gas leakage detection; Esp8266 Wi-Fi Shield Arduino; power usage tracking; Blynk apps

### ABSTRACT

This study addresses common challenges in conventional home electricity usage, with a focus on safety concerns related to gas leakage. In many cases, current technology lacks immediate power usage tracking, and manual control of circuit breakers, sockets, and lamps proves challenging, especially when users are away. To overcome these issues, this project employs an ESP8266 Wi-Fi Shield Arduino as a microcontroller connected to sensors and a servo motor. In the proposed system, users can detect gas leakage, control lamp and socket activation, and manage the Residual Current Circuit Breaker (RCCB) with the servo motor by utilizing Blynk apps for monitoring. The main objective of this study is to design a centralized system that enables users to control and manage home electrical appliances via smartphone. The methodology involves developing a microcontroller program for the Cytron ESP8266 WiFi Shield, creating an auto-reclosure circuit breaker notification, and building a practical gas leakage detection prototype for household applications. Additionally, the system addresses lightning-induced overvoltage issues, analyzes nuisance tripping, and provides control over home appliance usage while effectively detecting hazardous gas leaks. The approach is based on Blynk and the ESP8266 Wi-Fi Shield Arduino by incorporating data from limit switch conditions, relay status, voltage sensors, current sensors, and power consumption. The results justify the servo's efficient performance, reliable relay operations, and precise gas sensor triggering. Despite slight variations in current and voltage values compared to the actual meter, the system offers a successful and systematic approach to enhancing home electricity management and safety.

## 1. Introduction

Building automation systems for homes are becoming increasingly popular due to their numerous advantages, such as enhanced security, energy efficiency, remote monitoring and control, and

\* Corresponding author.

E-mail address: [nurazura@utem.edu.my](mailto:nurazura@utem.edu.my)

<https://doi.org/10.37934/aram.120.1.8598>

improved convenience for users [1]. Nowadays, most home automation systems aim to reduce human labor in the production of services and goods [2]. Automation efficiently utilizes electricity and water, minimizing waste and promoting economic use [3]. It involves the deployment of various sensors and actuators to manage lighting, temperature, and humidity, while also monitoring energy consumption in buildings, workplaces, schools, and museums [4,5].

Many researchers have introduced automation systems to enhance the home environment. Gill *et al.*, [6] introduced a ZigBee-based home automation system with a Wi-Fi network, allowing users to address the system's security and safety needs. Suma *et al.*, [7] addressed the issue of gas leakage in households by introducing a gas leakage detection and monitoring system using an MQ-5 sensor. Meanwhile, Meshram *et al.*, [8] incorporated Wi-Fi networking into a gas leakage system that alerts the user by sending an SMS message. Recently, Mendoza *et al.*, [9] introduced the ImHome system, allowing users to monitor dust, house lightning activation, and gas sensors, respectively. Most recently, Stolojescu Cristina *et al.*, [10] proposed a system called qToggle to control a series of home appliances and sensors.

With current technological advancements, various home problems can be highlighted for improvement. Previously, the ordinary distribution board lacked the capability to promptly notify consumers of potential disruptions or malfunctions. Consequently, users were compelled to independently diagnose and troubleshoot issues in the event of a power outage. Standard distribution boards lacked the sophisticated technology required to effectively mitigate the occurrence of vexatious tripping incidents. In instances where lightning strikes near the distribution board, it generates an electromagnetic wave with a propensity to induce excessive voltage, thereby posing a significant threat to the integrity of electronic devices within the household, such as televisions and refrigerators [11,12]. Furthermore, when the premises are unoccupied and an unwarranted tripping event ensues, users face an exacerbated predicament as they are unable to promptly activate the Residual Current Circuit Breaker (RCCB) due to their physical absence from the residence.

In a shared enclosure, an electrical power input is divided into subsidiary circuits, with each circuit equipped with a protection fuse or circuit breaker. More modern boards typically include residual-current devices (RCDs) [13,14] or residual current breakers with overcurrent protection (RCBOs) [14], along with a main switch. These distribution boards are commonly used in various settings such as homes, factories, and stores where electricity is required. Occasionally, during periods of high electrical demand, tripping may occur, leading to reduced productivity in a factory or disruptions in online work for individuals working from home [15]. However, with the availability of new technologies in today's era, one can address such situations.

By using Internet of Things (IoT)-connected smartphones, one can easily control and monitor the system, offering a solution to overcome these challenges. Due to the inherent capabilities of its Wi-Fi source, the Wi-Fi Shield ESP8266 is one example that provides wireless connectivity to Arduino and other microcontroller platforms. It is based on the ESP8266 microcontroller chip, which has built-in Wi-Fi capabilities. The shield allows devices to connect to Wi-Fi networks, communicate over the internet, and interact with web services [16-18]. It simplifies the process of adding Wi-Fi functionality to projects, making it easier to create IoT applications and remote-control systems. Recently, Shahajan *et al.*, [19] proposed an automatic electrical energy meter billing system using IoT, allowing consumers to keep track of energy consumption and reduce the waste of electrical energy efficiently. Meanwhile, Blynk, a mobile app, allows users to create a custom interface and remotely control the system [20]. Blynk provides a range of widgets and features that enable real-time data visualization, equipment control, and power consumption monitoring. Recently, Durani *et al.*, [21] used Wi-Fi Shield ESP8266 together with Blynk apps to monitor circuit devices. Most recently, Karuppusamy *et*

*al.*, [22] proposed a sensor-based monitoring station to monitor the efficiency of energy utilization by the control devices.

Currently, there is no proposed invention of a home automation system considering tripping events, monitoring gas leakage, and a system that is able to measure power consumption using voltage and current sensors while displaying the data on an LCD and Blynk simultaneously in the literature. Hence, this study aims to establish an operation within domestic settings while providing the convenience of remote monitoring from anywhere, whether inside or outside the house. Users can easily control and monitor numerous components using a smartphone. The Blynk platform seamlessly connects to a variety of crucial components, such as limit switches, servos, relays, gas sensors, voltage sensors, and current sensors. Additionally, the Arduino guarantees a steady power supply to the ESP8266 WiFi Shield, allowing for continuous operation. In the next section, the design and implementation of the system are highlighted.

## **2. Design and Implementation**

### *2.1 Block diagram*

The system is developed through a combination of software and hardware components. For the software component, a diverse array of equipment and materials is employed to facilitate the successful execution of the desired objectives. The central component of the system is the Arduino Uno, a versatile microcontroller board that serves as the brain of the system. It is complemented by the microcontroller Wi-Fi Shield ESP8266, which adds Wi-Fi connectivity, enabling wireless communication and integration with online resources. A servo motor is utilized to achieve precise control over the rotational position of mechanical parts, while limit switches provide essential input signals based on specific positions or limits in the system. The inclusion of an LCD display enhances the user interface by providing visual feedback and information display.

Additionally, voltage and current sensors enable accurate monitoring and control of electrical parameters. To ensure safety, the system incorporates MCBs (Miniature Circuit Breakers) and RCCBs (Residual Current Circuit Breakers) to protect against overloads, short circuits, and ground faults. A distribution box serves as a centralized hub for organizing electrical components and power distribution. Lastly, a switching power supply efficiently converts electrical power between voltage levels to meet the specific requirements of the project components.

As for the software component, the Proteus software is chosen to construct the system. Proteus provides a user-friendly and interactive platform for designing and simulating circuits. It enables users to drag and drop components, connect them together, and visualize the circuit's functionality before physical implementation. Regarding the coding aspect, the Arduino Software (IDE) is utilized. The Arduino IDE is a popular development environment that simplifies the programming process for Arduino boards. It offers a comprehensive set of libraries and functions that facilitate the writing, compilation, and uploading of code to the Arduino Uno or other compatible boards. To enhance the system's capabilities, the Blynk application is integrated with the Arduino IDE.

Blynk allows users to create a custom interface and control their projects remotely. By integrating Blynk with the Arduino code, users can monitor and control their projects using their smartphones or tablets. To establish a connection between the Arduino and the Blynk app, a Wi-Fi Shield ESP8266 will be employed. The Wi-Fi Shield ESP8266 is an expansion board that adds Wi-Fi connectivity capabilities to the Arduino, enabling it to connect to the internet and communicate with the Blynk app. The Arduino code is uploaded to the ESP8266 via a USB cable, allowing for seamless communication between the Arduino, Wi-Fi Shield, and the Blynk app. Once the system is set up and running, the Blynk application serves as a user-friendly interface, displaying all the connected

equipment and providing real-time monitoring of power consumption. This combination of Proteus, Arduino IDE, Blynk, and the Wi-Fi Shield ESP8266 creates a comprehensive solution for designing, coding, and remotely controlling and monitoring the system. A simple block diagram represents the home automation system, as shown in Figure 1.

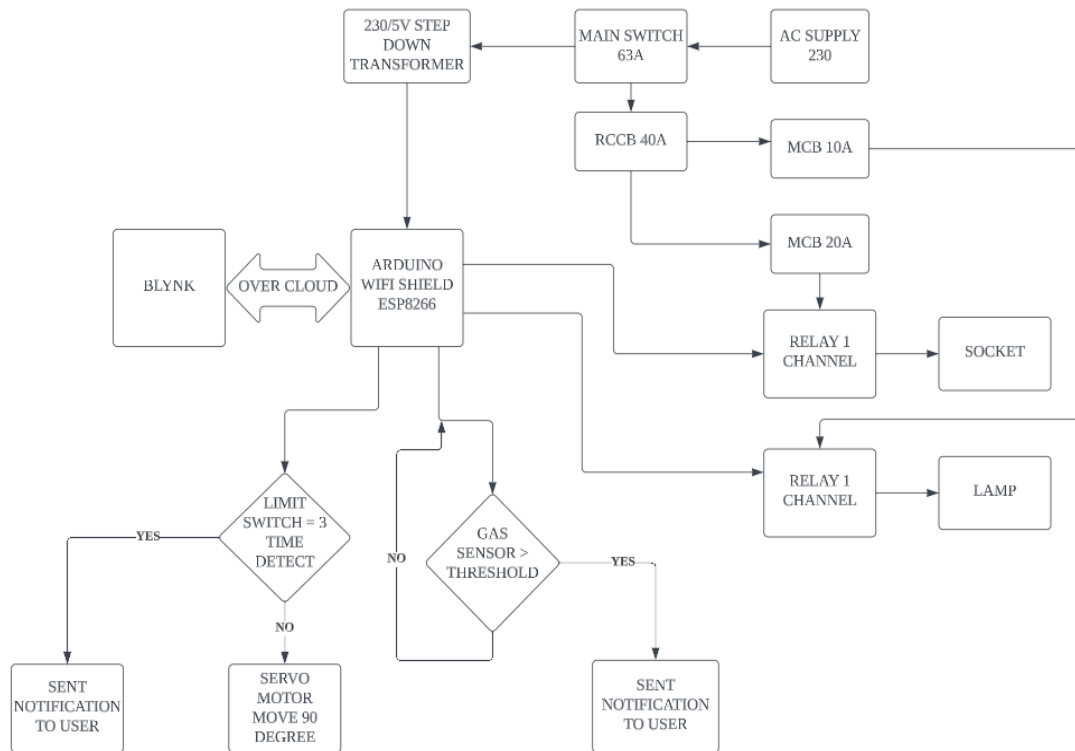
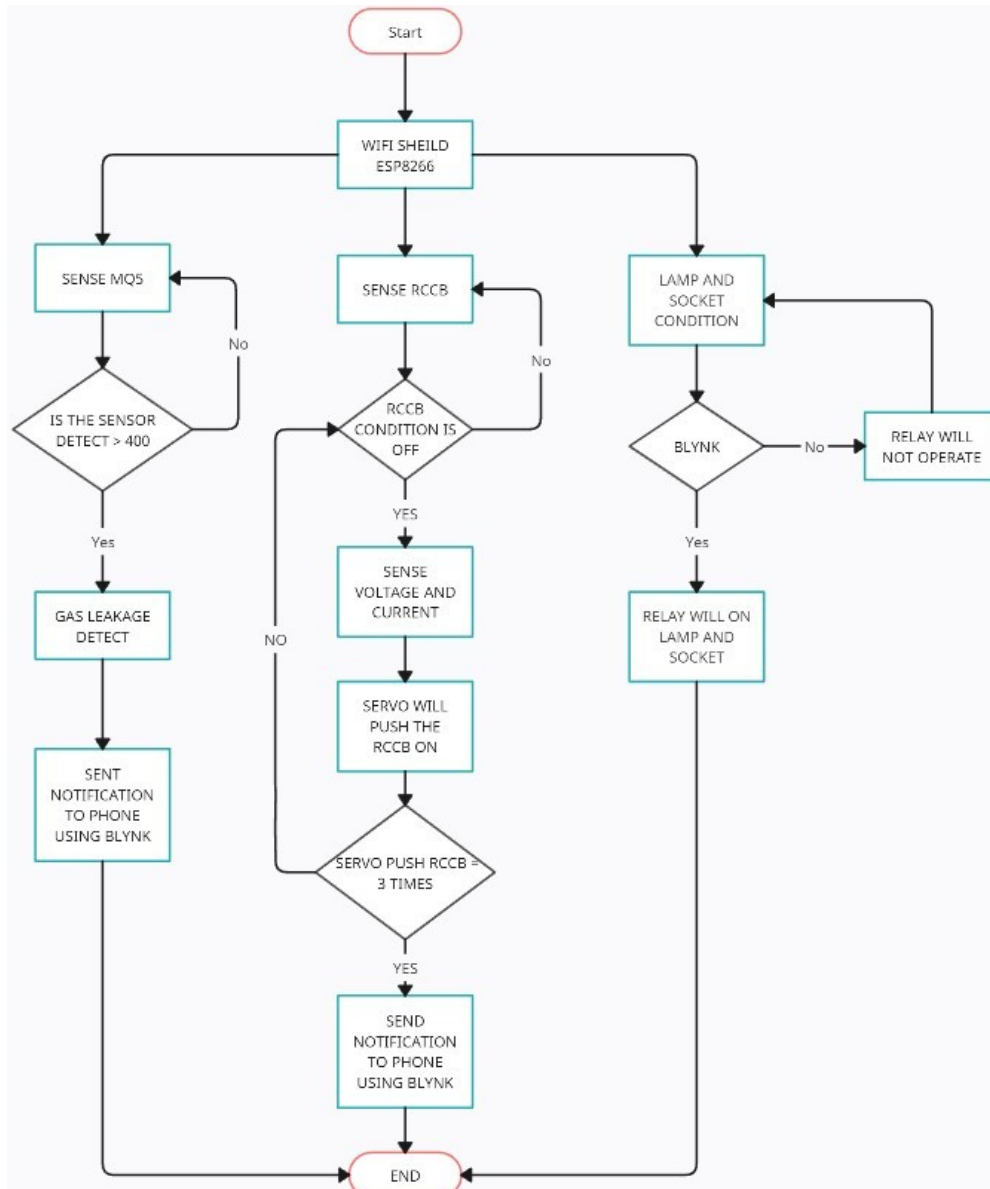

Fig. 1. Block Diagram of the System

## 2.2 System Development

Through the utilization of diverse equipment and materials, the system can create a comprehensive solution that combines wireless communication, precise motor control, position sensing, data visualization, electrical parameter monitoring, safety mechanisms, and efficient power distribution. The objective of this system is to enhance the technology of a distribution box by incorporating IoT, ensuring continuous connectivity between the distribution box and the user.

Figure 2 displays the flow chart of the system. Essentially, the project commences with the Wi-Fi Shield ESP8266, serving as the central processing unit of the entire project. Upon applying the code to the Wi-Fi Shield ESP8266, it detects the codes and initiates the process. If the RCCB switch is tripped, the limit switch will push it back to the ON position. However, if the tripping event occurs three times and the RCCB remains tripped, the system will cease pushing the RCCB to the ON position and send a notification to the consumer, indicating that the RCCB is malfunctioning.



**Fig. 2.** Flow chart of the system

Additionally, the user can control lamps and sockets using the microcontroller Wi-Fi Shield ESP8266 to turn them on or off. The user can monitor power usage from their phone, and the Wi-Fi Shield ESP8266 can also detect gas leakage at home. In the event of a gas leakage at home, the Wi-Fi Shield ESP8266 will send a notification through the phone to alert the user. The next section presents the software design and hardware operation, followed by the testing results.

### 3. Working of the System

In this section, the system is described in two subsections. First, the software design of the system is highlighted. In the next part, the hardware operations and testing results are presented.

#### 3.1 Software design

The software design was created using an online platform called Proteus Simulation. The hardware can be built, run, or tested directly online if there is an internet connection. The main

components that must be available include the Microcontroller, Arduino Uno, voltage sensor, current sensor, relay, gas leakage sensor, LCD, bulb, and servo motor. Figure 3 illustrates the simulation diagram.

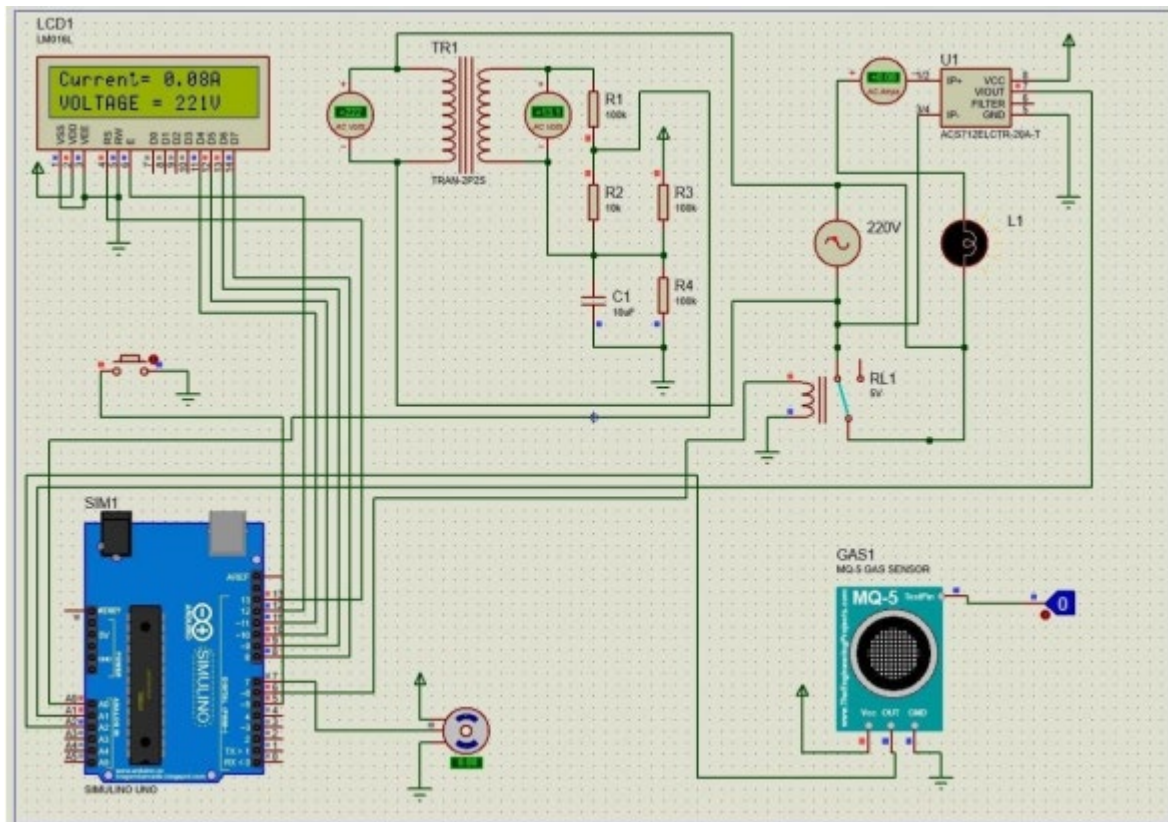

Fig. 3. Proteus Simulation of the system.

The voltage sensor handles single-phase voltage at 240V, while the current sensor supports up to 50 amps, detecting and monitoring load current. Upon microcontroller activation, the relay controls the lamp's on/off state, accessible via a mobile phone. The gas sensor measures gas leakage nearby, and the LCD displays voltage, current, and gas status. The servo motor resets the RCCB switch to ON, with a rating of 20kg/cm. Relevant data, including current, voltage, power, gas sensor readings, and tripping events, can be monitored via the Blynk app on a mobile phone.

### 3.1.1 Arduino Instruction

The coding for this project utilizes the Arduino Integrated Development Environment (IDE) software. Most modern operating systems provide support for this open-source programming language, based on C and C++. A comprehensive understanding of the C++ programming language is essential for effectively modifying programming instructions. The microcontroller employed in this system is the ESP8266 Wi-Fi Shield. It was specifically chosen due to its enhanced capabilities compared to the Arduino UNO. Notably, it possesses a comparable number of analogue and digital input pins. The following Arduino code is utilized to simulate the Proteus software. This Arduino code is responsible for providing instructions to various components, including the voltage sensor, current sensor, gas sensor, relay, servo, and limit switch, enabling them to operate according to the predetermined plan as outlined in Figure 4.

```

#include <LiquidCrystal.h>
#include "EmonLib.h"
#define MOPin A2

LiquidCrystal lcd(13, 12, 11, 10, 9, 8);

EnergyMonitor emon1;

const int Sensor_Pin = A1;
int sensitivity = 185;
int offsetvoltage = 2532;
int relaypin = 6;
int power;
int BUTTON_PIN = 5;
double kilowh = 0;
double pf=0;

void setup()
{
    emon1.voltage(A0,187, 1.7);
    pinMode(BUTTON_PIN, INPUT_PULLUP);
    pinMode(relaypin, OUTPUT);
    pinMode(MOPin, INPUT_PULLUP);
    lcd.begin(16,2);
    lcd.setCursor(0,0);
    lcd.print("MEASUREMENT");
    lcd.setCursor(0,1);
    lcd.print("AC CURRENT");
    delay(100);
    lcd.clear();
}

void loop()
{
    emon1.calcVI(20,2000);
    int Voltage1 = emon1.Vrms;
    int gas_value = digitalRead(MOPin);

    if(gas_value==HIGH)
    {
        lcd.clear();
        lcd.setCursor(6, 0);
        lcd.print("GAS");
        lcd.setCursor(3, 1);
        lcd.print("DETECTED");
        delay(1000);
    }

    byte buttonState = digitalRead(BUTTON_PIN);
    if (buttonState == LOW)
    {
        lcd.clear();
        lcd.setCursor(0, 0);
        lcd.print("P =");
        lcd.print(power);
        lcd.print("W");
        lcd.setCursor(0,1);
        lcd.print("WH =");
        lcd.print(kilowh);
        lcd.print("KWH");
        lcd.setCursor(8,0);
        lcd.print("PF");
        lcd.print(pf);
        delay(1000);
    }

    double AC_Current = 0;
    unsigned int temp=0;
    float maxpoint = 0;
    for(int i=0;i<500;i++)
    {
        if(temp = analogRead(Sensor_Pin), temp>maxpoint)
        {
            maxpoint = temp;
        }
    }
    float ADCvalue = maxpoint;
    double Voltage = (ADCvalue / 1024.0) * 5000;
    double Current = ((Voltage - offsetvoltage) / sensitivity);
    AC_Current = - (( Current ) / ( sqrt(2) ));
    digitalWrite(relaypin,HIGH);
    delay(100);
    lcd.setCursor(0,0);
    lcd.print("Current=");
    lcd.print(AC_Current);
    lcd.print("A");
    delay(100);

    lcd.setCursor(0,1);
    lcd.print("Voltage = ");
    lcd.print(Voltage);
    lcd.print("V");
    delay(100);

    power = Voltage1*AC_Current;
    delay(100);
    kilowh = power*60;
    delay(100);
    pf = power / (Voltage1*AC_Current);
    delay(100);
}
    
```

**Fig. 4.** Arduino Codes of The System

The findings include a comprehensive analysis derived from simulation and manual data collection methods. Table 1 displays disparities in voltage, current, and power between Proteus simulation and clamp meter measurements. Table 2 provides gas sensor measurements obtained exclusively through the Proteus simulation, highlighting accuracy and reliability. Table 3 reveals insights into servo control motion and its response to the limit switch, demonstrating the efficacy and performance of the system. These tables offer a comprehensive set of data for evaluating and analyzing the simulation and measurement results obtained from Proteus, providing valuable insights into the systems and components.

**Table 1**  
 Measurement Current, Voltage and Power

	Clamp meter	Simulation
Voltage	230V	230V
Current	0.11 A	0.08 A
Power	25.3 W	18.4W

**Table 2**  
 Gas Sensor Measurement

Event	Simulation On Gas Sensor
Gas Leakage Happen	LCD show gas detected
No Gas Leakage Happen	LCD does not display

**Table 3**  
 Servo Motor and Limit Switch Condition

Event	Limit Switch	Servo Motor
No trip	No Trigger	0 degree
Trip	Trigger	90 degrees

The comprehensive analysis of the obtained results reveals intriguing insights across multiple aspects. First, upon examining the findings from Table 1, a slight disparity between the Proteus simulation and the clamp meter measurements is observed in terms of current and voltage. This discrepancy can be attributed to the inherent differences between theoretical calculations and

practical simulations within the Proteus software. It is crucial to acknowledge that simulations may not perfectly mirror real-world conditions, leading to minor variations in the measured values.

Table 2 in the Proteus simulation showcases the gas leakage measurements through the utilization of the software's dedicated gas module. The simulated gas sensor triggers the LCD display to indicate any occurrence of gas leakage within a household. However, it is important to note that this simulation employs a toggle condition instead of an actual MQ5 gas sensor. While the Proteus simulation provides a basic understanding of gas leakage events, using an MQ5 gas sensor in practical hardware implementation would yield more accurate and reliable gas leakage values.

Meanwhile, Table 3 illustrates the behavior of the servo motor based on the signals received from the limit switch. The obtained results indicate that when the limit switch is triggered, the servo motor moves to a 90-degree angle. Conversely, if the limit switch remains inactive, the servo motor returns to the 0-degree angle before moving again by 90 degrees to activate the limit switch. Comparing the Proteus simulation to the hardware implementation, it is evident that the movement of the servo motor and the behavior of the limit switch align closely.

### 3.2 Hardware

The idea of this system is to enhance the technology of a distribution box by adding a touch of IoT so that the distribution box is always connected to the user. If the RCCB switch is tripped, the limit switch will push it back ON. If the event happens three times but the RCCB still trips, it will stop pushing the RCCB ON and send out a notification to the consumer, indicating that the RCCB is broken. Figure 5 illustrates the hardware of the system.



**Fig. 5.** The hardware of the system

Additionally, the user can also control lamps and sockets using the microcontroller Wi-Fi Shield ESP8266 to turn them on or off. The user can monitor power usage from their phone, and the Wi-Fi Shield ESP8266 can also detect gas leakage at home. When a gas leakage occurs at home, the Wi-Fi Shield ESP8266 will send a notification through the phone using the Blynk app to alert the user. Figure 6 displays the Blynk app interface.



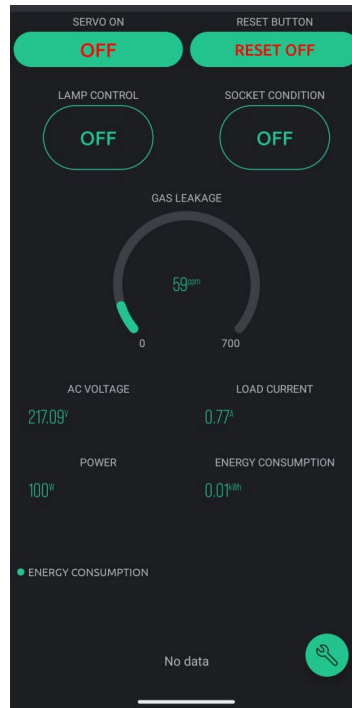

**Fig. 6.** The interface of Blynk apps

### 3.2.1 Relay

The relay was thoroughly tested using a mobile device to control the turning on and off of both a lamp and a socket. Relay 1 is specifically designed to manage the lamp, allowing it to be turned on and off as needed. On the other hand, Relay 2 is focused on handling the socket, taking charge of both the starting and stopping of the electrical connection for the lamp. Table 4 provides a detailed breakdown of how long it takes for each relay to perform its designated tasks.

**Table 4**  
 Time taken relay to operate

Relay	Time taken for turn on	Time taken for turn off
1	0.4 s	0.3 s
2	0.4 s	0.3 s

The information extracted from the table pertains to the duration required for both Relay 1 and Relay 2 to execute their operations, specifically in the context of activating the lamp and the socket outlet. A discernible distinction is noted in the operational time between Relay 1 and Relay 2, elucidating the variance in the temporal sequences for the initiation and cessation of these relays, as they contribute to the activation and deactivation processes of the lamp and socket outlet.

### 3.2.2 Auto reclosure

The tripping event was tested for multiple sets. One set consists of more than three instances of tripping to ensure that the prototype is fully functional. In this case, the Distribution Board included a load with 2 LED Bulbs and a Water Heater. Table 5 and Table 6 show the tripping events and how many times the system counters the tripping event.

In Set 1, the result stems from the servo condition aimed at applying a counteractive force against the residual-current circuit breaker (RCCB) during the fourth instance of nuisance tripping, thereby mitigating and addressing the repetitive interruption.

**Table 5**

Tripping event

Event of Nuisance Tripping	Does the servo motor push back the RCCB	Comment
First nuisance tripping	Yes	The RCCB is back ON and the circuit is fully running.
Second nuisance tripping	Yes	The RCCB is back ON and the circuit is fully running.
Third nuisance tripping	Yes	The RCCB is back ON and the circuit is fully running.
Fourth nuisance tripping	Yes	The RCCB is still OFF and the user will receive notification

For Set 2, the condition arises following the resetting of Set 1, and this signifies the result for Set 2 after the entire reset process has been finalized.

**Table 6**

Time taken for the servo motor to push back the RCCB back to ON state

Event of Nuisance Tripping	Does the servo motor push back the RCCB	Comment
First nuisance tripping	Yes	The RCCB is back ON and the circuit is fully running.
Second nuisance tripping	Yes	The RCCB is back ON and the circuit is fully running.
Third nuisance tripping	Yes	The RCCB is back ON and the circuit is fully running.
Fourth nuisance tripping	Yes	The RCCB is still OFF and the user will receive notification

In the event of a fault tripping, there is a fault if one attempts to push the RCCB back to the ON state, but the RCCB will consistently return to the OFF state. Assuming that the trip occurs three times within 10 seconds, it indicates a fault tripping rather than nuisance tripping. It is important to note that the prototype's performance depends on the speed and strength of the internet connection. If the internet connection is weak, it may affect the speed of countering the tripping event.

### 3.2.3 Gas Sensor

Table 7 presents the experimental results of gas detection time taken for various distances and the condition of the buzzer when gas was detected.

**Table 7**  
Experimental result of gas and buzzer conditions

Distance (cm)	Gas detected		Buzzer condition
	Value (ppm)	Time taken (s)	On / off
0	700	1	On
30	348	1	On
60	274	1	On
90	318	2	On
120	273	3	On
150	330	4	On
180	335	5	On

The tabular representation elucidates information acquired from a gas detection sensor, encompassing details such as distance, gas concentration measured in parts per million (ppm), the duration of the data collection process, and the operational state of the buzzer. Upon examining the table, it becomes apparent that the activation time of the buzzer is contingent upon the gas concentration exceeding 300 ppm.

### 3.2.4 Energy consumption

To ensure the successful realization of this project, the Blynk application serves as a pivotal tool, responsible for generating comprehensive calculation results, particularly in the domain of energy consumption. Beyond its calculative functions, the Blynk application assumes a dual role as a communication medium, facilitating user interaction for monitoring the energy consumption of all household appliances integrated into the system. Moreover, this undertaking places significant emphasis on the intricate calculations executed by the system, culminating in the development of a simplified circuit diagram that accurately reflects the load and power supply dynamics in accordance with real-time requirements. The comparison shown in Figure 8 explains the noticeable differences between the current values displayed by the Blynk application and the real current observed at the same times in the system.

Examining the provided visual representation from Figure 7, the assessment of lamp current involves the utilization of both a clamp meter and a current sensor integrated into the Arduino system, with a focus on the current consumption over a span of one hour. It is observable that the stability of the current measurement obtained from the clamp meter surpasses that of the current sensor interfaced with the ESP8266 Wi-Fi Shield Arduino Uno. Specifically, the readings acquired from the clamp meter yield values of 0.08 and 0.075, exhibiting a marginal variance when compared to the values derived from the Arduino current sensor.

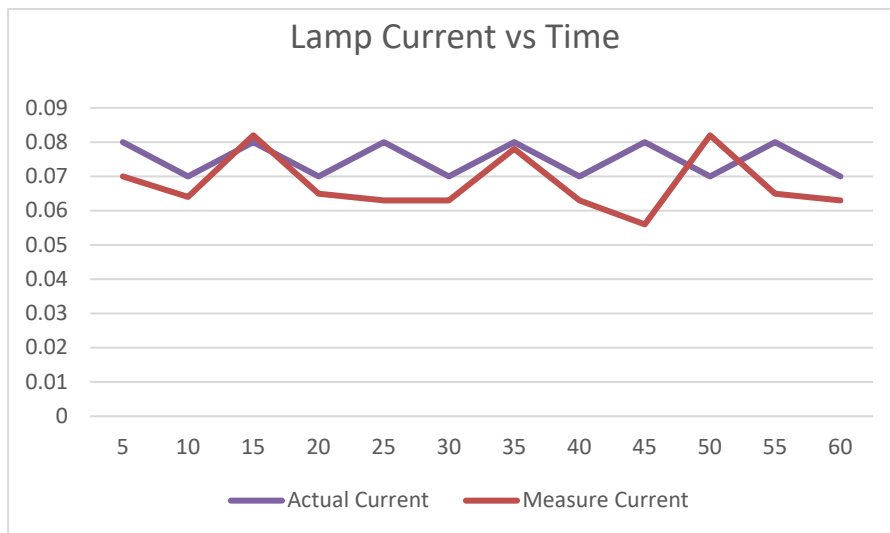

**Fig. 7.** Current flow lamp through the system shows by Blynk application and actual current in respective time taken

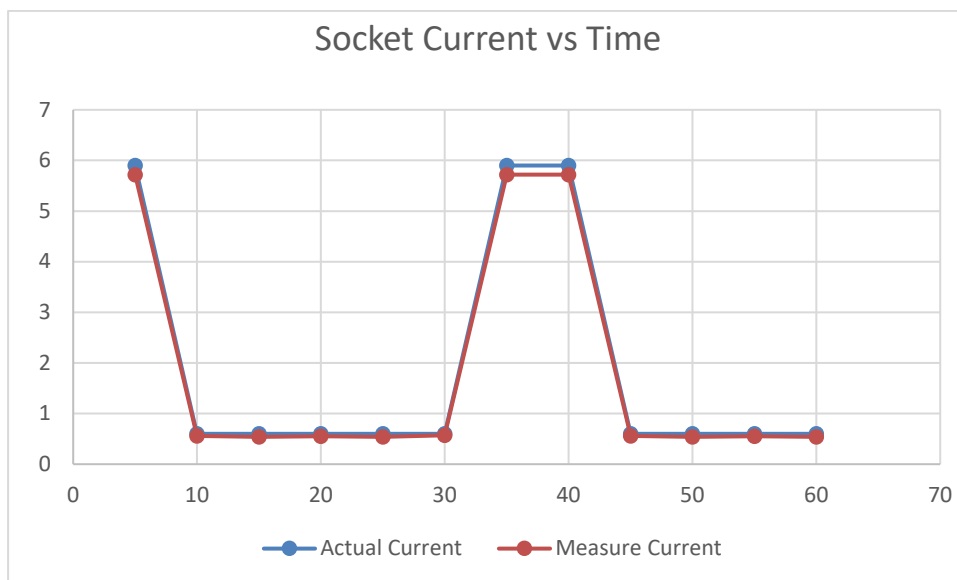

**Fig. 8.** Current flow socket outlet through the system shows by Blynk application and actual current in respective time taken

From Figure 8, there is a slight difference between the actual current and the measured current. Note that the measured current depends on the electrical connection from the socket outlet to devices such as the heater, phone charger, and laptop charger. The results are based on the amount of current used per hour. As for the heater, the current usage is 5.5 amperes. Meanwhile, for the phone charger, the current usage is only 0.13 amperes, and the laptop charger uses around 0.27 amperes of current. It is important to note that these are the actual current readings recorded based on the readings obtained from a clamp meter. Meanwhile, the measured current readings were collected from a sensor in the ESP8266 Wi-Fi Shield Arduino Uno.

Figure 9 shows that the energy consumption for the phone charger, laptop charger, and lamp is proportional to time based on a 1-hour consumption. The graph displays the specific amounts of electricity and the current readings from the Arduino current sensor. The objective of this data collection is to determine the total electrical power consumption for each device in a continuous

one-hour time frame. It is important to note that the total energy usage includes situations where both the phone and laptop are still in use while being charged.

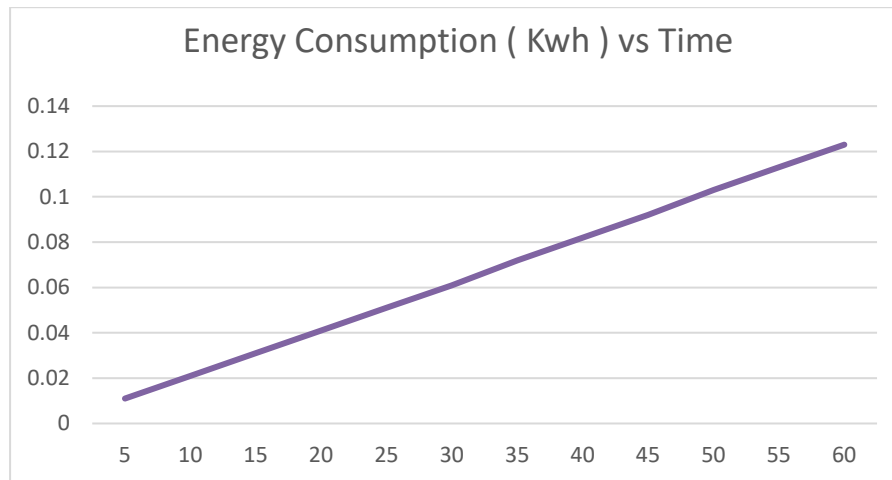

Fig. 9. Energy consumption against time graph

#### 4. Conclusions

This paper introduces the development of a home automation and safety circuit breaker for detecting gas leakage and tracking power usage using Arduino and the Blynk interface. The project focuses on testing several cases involving tripping time, monitoring current, voltage, power, and gas leakage values. Our prototypical system is applicable for measuring the tripping time from the servo motor to test the time taken for the RCCB when it operates. This system is also able to compute energy consumption by the load using voltage and current sensors, limited to 1-hour usage. Additionally, the system can detect gas leakage with a maximum distance of 180 cm, where the electronic component MQ5 gas sensor is used to obtain the exact value of gas leakage, and the user will receive a notification if a gas leakage event occurs through the Blynk Apps. To automate the home, relays were used to control the lamps and sockets.

This implementation offers an intelligent, comfortable, and energy-efficient home automation system. However, Blynk has a limitation in which the Wi-Fi username and password need to be set up first in the codes, restricting accessibility. In the future, an Android application can be considered to improve accessibility and provide more convenience in accessing power consumption data.

#### Acknowledgement

The authors would like to express gratitude to the Centre for Research and Innovation Management of Universiti Teknikal Malaysia Melaka (UteM) for the financial support this work under the Grant Tabung Penerbitan Fakulti dan Tabung Penerbitan CRIM UteM.

#### References

- [1] Asadullah, Muhammad, and Ahsan Raza. "An overview of home automation systems." In *2016 2nd international conference on robotics and artificial intelligence (ICRAI)*, pp. 27-31. IEEE, 2016. <https://doi.org/10.1109/ICRAI.2016.7791223>
- [2] Alheraish, Aloy. "Design and implementation of home automation system." *IEEE Transactions on Consumer Electronics* 50, no. 4 (2004): 1087-1092. <https://doi.org/10.1109/TCE.2004.1362503>
- [3] Ransing, Rasika S., and Manita Rajput. "Smart home for elderly care, based on Wireless Sensor Network." In *2015 International Conference on Nascent Technologies in the Engineering Field (ICNTE)*, pp. 1-5. IEEE, 2015. [doi: 10.1109/ICNTE.2015.7029932](https://doi.org/10.1109/ICNTE.2015.7029932)

- [4] O'Grady, Timothy, Heap-Yih Chong, and Gregory M. Morrison. "A systematic review and meta-analysis of building automation systems." *Building and Environment* 195 (2021): 107770. <https://doi.org/10.1016/j.buildenv.2021.107770>
- [5] Arulkumar, V., F. Kavin, and Bharathiraja Nagu. "IoT Sensor Data Retrieval and Analysis in Cloud Environments for Enhanced Power Management." *Journal of Advanced Research in Applied Sciences and Engineering Technology* 38, no. 1 (2024): 77-88. <https://doi.org/10.37934/araset.38.1.7788>
- [6] Gill, Khusvinder, Shuang-Hua Yang, Fang Yao, and Xin Lu. "A zigbee-based home automation system." *IEEE Transactions on Consumer Electronics* 55, no. 2 (2009): 422-430. <https://doi.org/10.1109/TCE.2009.5174403>
- [7] Suma, V., Ramya R. Shekar, and Kumar A. Akshay. "Gas leakage detection based on IOT." In *2019 3rd International conference on Electronics, Communication and Aerospace Technology (ICECA)*, pp. 1312-1315. IEEE, 2019. <https://doi.org/10.1109/ICECA.2019.8822055>
- [8] Meshram, Pranay, Nancy Shukla, Stuti Mendhekar, Renuka Gadge, and Shivani Kanaskar. "IoT Based LPG Gas Leakage Detector." *International Journal of Scientific Research in Computer Science, Engineering and Information Technology* 5, no. 1 (2019): 531-534. <https://doi.org/10.32628/CSEIT1951128>
- [9] Mendoza, Ian Carlo P., Shaun Matthew Timbol, Mary Jane C. Samonte, and Eric B. Blancaflor. "ImHome: An IoT for smart home appliances." In *2020 IEEE 7th International Conference on Industrial Engineering and Applications (ICIEA)*, pp. 761-765. IEEE, 2020. <https://doi.org/10.1109/ICIEA49774.2020.9101906>
- [10] Stolojescu-Crisan, Cristina, Calin Crisan, and Bogdan-Petru Butunoi. "An IoT-based smart home automation system." *Sensors* 21, no. 11 (2021): 3784. <https://doi.org/10.3390/s21113784>
- [11] Yokoyama, S. "Lightning protection on power distribution lines against direct lightning hits. Kaku haidensen no chokugeki kaminari taisaku." *Denki Gakkai Ronbunshi, B (Transactions of the Institute of Electrical Engineers of Japan. Power and Energy);(Japan)* 114, no. 6 (1994). [https://doi.org/10.1541/ieejpes1990.114.6\\_564](https://doi.org/10.1541/ieejpes1990.114.6_564)
- [12] Liu, Qianling, Hisho Nakamura, Yantao Huang, Shinji Yasui, Masaya Nakagawa, and Tatsuya Yamamoto. "Effect of Wiring Installation System on Overvoltage at the Distribution Boards of a Building Struck Directly by Lightning." In *2023 12th Asia-Pacific International Conference on Lightning (APL)*, pp. 1-5. IEEE, 2023. <https://doi.org/10.1109/APL57308.2023.10181755>
- [13] Freschi, Fabio. "High-frequency behavior of residual current devices." *IEEE Transactions on Power Delivery* 27, no. 3 (2012): 1629-1635. <https://doi.org/10.1109/TPWRD.2012.2191423>
- [14] Czapp, Stanislaw, and Hanan Tariq. "Behavior of residual current devices at frequencies up to 50 kHz." *Energies* 14, no. 6 (2021): 1785. <https://doi.org/10.3390/en14061785>
- [15] Mafi, Hossein, Rami Yared, and Layachi Bentabet. "Smart residual current circuit breaker with overcurrent protection." In *2019 IEEE 2nd international conference on renewable energy and power engineering (REPE)*, pp. 6-9. IEEE, 2019. <https://doi.org/10.1109/REPE48501.2019.9025151>
- [16] Jose, Akhil, Aneeta M. Varghese, Femi Elie Jenson, Philip Jacob, D. M. Anumod, and Dennis Thomas. "Solid-state circuit breaker based smart distribution board with IoT integration." In *2020 Third International Conference on Smart Systems and Inventive Technology (ICSSIT)*, pp. 54-61. IEEE, 2020. <https://doi.org/10.1109/ICSSIT48917.2020.9214172>
- [17] Mehta, Manan. "ESP8266: A Breakthrough in wireless sensor networks and internet of things." *International Journal of Electronics and Communication Engineering & Technology* 6, no. 8 (2015): 7-11.
- [18] Mansor, Muhammad Naufal, Noor Anida Abu Talib, Syahrul Affandi Saidi, Wan Azani Mustafa, and Nurul Fakhirah Zamri. "Arduino IOT Based Inventory Management System Using Load Cell and NodeMCU." *Journal of Advanced Research in Applied Sciences and Engineering Technology* 32, no. 3 (2023): 12-25. <https://doi.org/10.37934/araset.32.3.1225>
- [19] Miah, Shahajan, GM Jahedul Islam, S. Kanti Das, Shahidul Islam, Mirajul Islam, and Kazi Kamrul Islam. "Internet of Things (IoT) based automatic electrical energy meter billing system." *IOSR Journal of Electronics and Communication Engineering* 14, no. 4 (I) (2019): 39-50.
- [20] Thaker, Tejas. "ESP8266 based implementation of wireless sensor network with Linux based web-server." In *2016 Symposium on Colossal Data Analysis and Networking (CDAN)*, pp. 1-5. IEEE, 2016. <https://doi.org/10.1109/CDAN.2016.7570919>
- [21] Durani, Homera, Mitul Sheth, Madhuri Vaghasia, and Shyam Kotech. "Smart automated home application using IoT with Blynk app." In *2018 Second international conference on inventive communication and computational technologies (ICICCT)*, pp. 393-397. IEEE, 2018. <https://doi.org/10.1109/ICICCT.2018.8473224>
- [22] Karuppusamy, P. "A sensor based IoT monitoring system for electrical devices using Blynk framework." *Journal of Electronics and Informatics* 2, no. 3 (2020): 182-187. <https://doi.org/10.36548/jei.2020.3.005>