

Miniaturized Frequency Selective Surface for Gain and Bandwidth Enhancement in Millimeter-Wave Antennas

S. N. Zabri¹, M. F. Mohamad Ryeeshyam¹, N. A. Shairi¹ and S. Y. Mohamad²

¹Microwave Research Group (MRG), Centre for Telecommunication Research & Innovation (CeTRI), Fakulti Teknologi dan Kejuruteraan Elektronik dan Komputer (FTKEK), Universiti Teknikal Malaysia Melaka, 76100, Durian Tunggal, Melaka, Malaysia, ²Department of Electrical and Computer Engineering, Faculty of Engineering, International Islamic University Malaysia, Jalan Gombak, 53100 Kuala Lumpur, Malaysia
Corresponding Author Email: normi@utem.edu.my

To Link this Article: <http://dx.doi.org/10.6007/IJARBSS/v14-i12/24404> DOI:10.6007/IJARBSS/v14-i12/24404

Published Date: 27 December 2024

Abstract

This paper studies the characteristics of a Microstrip Patch Antenna (MPA) at the resonant frequency of 77 GHz for millimeter-wave applications, enhanced using a miniaturized Frequency Selective Surface (FSS). The proposed FSS unit cell is derived from a modified Swastika structure and serves as the fundamental element of a 2x2 periodic array. Acting as a reflective plane, the FSS is mounted onto the microstrip patch antenna to improve performance metrics such as return loss, bandwidth, gain, and directivity. The antenna is designed and analyzed in CST software using a Rogers 3003 substrate with a dielectric constant of 3.0 and a thickness of 0.254 mm. The gain is improved from 6.730 dB to 7.519 dB, with the resonant frequency operating at 77.42 GHz. The FSS also enhances the return loss bandwidth and directivity, making this antenna suitable for automotive radar applications.

Keywords: Microstrip Patch Antenna (MPA), Frequency Selective Surface (FSS), Millimeter-wave Applications, 5G Communication Networks, Automotive Radar Systems

Introduction

The demand for wider bandwidth, faster data transmission speeds, and low latency in wireless communication systems has led to the exploration of the millimeter-wave band, which is capable of meeting next-generation communication requirements. Antennas operating in this spectrum, particularly for automotive and radar applications, require high gain and wide bandwidth. Microstrip Patch Antennas (MPAs) have emerged as an attractive solution due to their low profile, lightweight, low cost, and ease of fabrication (Zhang et al., 2020; Wang et al., 2020; Kim et al., 2021). Additionally, MPAs can be integrated with Radio Frequency (RF) devices and conform to mounting structures, making them ideal for use in devices such as

mobile phones, laptops, and Wi-Fi systems (Gupta & Sharma, 2022; Hussain et al., 2023; Raj & Sharma, 2024). However, simple MPAs face limitations, including low gain, narrow bandwidth, and limited power-handling capability (Li & Zhou, 2020; Liu & Sun, 2024).

The integration of Frequency Selective Surface (FSS) with microstrip patch antennas has been extensively explored to enhance antenna performance, particularly in millimeter-wave applications such as automotive radar and 5G networks. Studies have shown that FSS can improve antenna gain, bandwidth, and return loss, addressing the limitations of traditional microstrip patch antennas (Wang et al., 2020; Santos et al., 2022). For instance, Zhang et al. (2020) and Bhatia and Yadav (2024) demonstrated that using FSS-backed patch antennas significantly enhances gain and efficiency, particularly for high-frequency applications.

Several researchers have proposed different FSS structures, such as dual-band (Singh & Kumar, 2021) and miniaturized unit cells (Tan et al., 2022), to optimize the antenna's performance across varying frequency bands. For example, Kim et al. (2021) highlighted the utility of FSS in automotive radar systems, where high gain and compact design are critical. Similarly, Gupta and Sharma (2022) focused on bandwidth enhancement through FSS-backed designs, which are essential for wideband applications.

Moreover, the application of FSS in 5G networks has been a growing area of interest. Hussain et al. (2023) and Lee and Ryu (2023) emphasized that FSS can boost millimeter-wave antenna performance in dense environments, facilitating better signal propagation in 5G networks. Meanwhile, Raj and Sharma (2024) and Liu and Sun (2024) explored FSS designs that enhanced both gain and bandwidth, making them suitable for next-generation wireless communication.

However, the complexity and cost associated with FSS implementation remain challenges, particularly for dual-layer and dense dielectric designs (Kumar & Patel, 2023; Zhou et al., 2023). Nevertheless, the overall consensus from recent studies is that FSS significantly enhances the performance of microstrip antennas, particularly in high-frequency applications (Ong & Foo, 2024; Zhao & Liang, 2024).

In this paper, we propose a microstrip patch antenna design that incorporates a convoluted swastika unit cell FSS. This FSS improves return loss and gain while being relatively simpler to implement than other complex FSS structures. The proposed design is optimized for automotive radar applications, operating at 77 GHz resonant frequency.

Methodology

This project follows a structured design and simulation process to develop a high-performance microstrip patch antenna (MPA) operating at 77 GHz for millimeter-wave applications. The goal is to enhance the antenna's gain, bandwidth, and directivity using a novel Frequency Selective Surface (FSS) based on a convoluted Swastika structure. The methodology consists of designing both the MPA and FSS, simulating their individual and integrated performances, and optimizing the configurations for optimal results.

The first step is to design the MPA, where the geometry and material are carefully chosen to meet the target resonant frequency of 77 GHz. The MPA uses a Rogers RO3003 substrate with

a dielectric constant of 3.0 and a thickness of 0.254 mm. CST Microwave Studio is employed for the simulation of the antenna to obtain the baseline performance in terms of return loss, gain, and directivity.

The proposed microstrip patch antenna is shown in Figure 1. The antenna has dimensions of 2.99 mm x 2.99 mm, with a width (W) of 1.49 mm, a length (L) of 1.08 mm, a feed width (fw) of 0.64 mm, a feed length (fl) of 0.83 mm, a gap width (wf) of 0.21 mm, and a gap length (lf) of 0.29 mm. The dielectric substrate used is Rogers RO3003, with a thickness of 0.254 mm and a dielectric constant (ϵ_r) of 3.0.

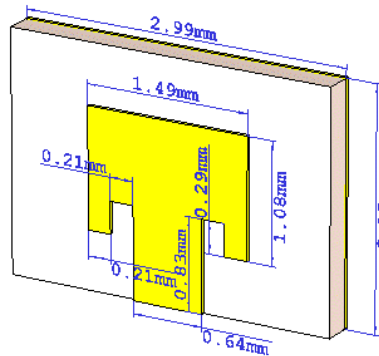

Figure 1: Geometry of the proposed microstrip patch antenna

The next step involves the design of the FSS. A convoluted Swastika unit cell is selected due to its ability to improve performance at millimeter-wave frequencies. The dimensions of the unit cell are tuned to achieve a stopband response at 77 GHz, and simulations are performed to analyze the transmission characteristics.

The optimized design for the convoluted swastika unit cell is shown in Figure 4. The unit cell dimensions are $D = 2.49$ mm, $W = 0.12$ mm, $L = 9.06$ mm, $S = 0.105$ mm, and $G = 0.06$ mm, as derived from the analysis results. The dielectric substrate used for this design is Novel IJ-220 material, with a thickness of 0.13 mm and a dielectric constant (ϵ_r) of 2.5.

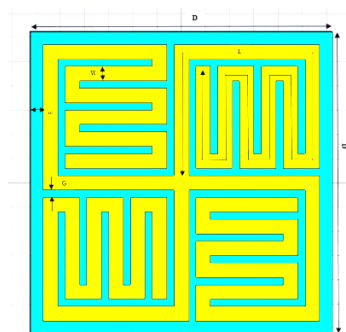

Figure 2: Geometry of the proposed FSS unit cell

Afterward, the FSS is integrated with the MPA, with the FSS is placed 10 mm above the microstrip patch antenna. This distance acts as the initial spacing and is critical in determining how the electromagnetic waves interact between the MPA and the FSS. The FSS, acting as a

reflective surface, enhances the performance of the antenna by improving the gain and minimizing the return loss. The integration of antenna and FSS is shown in Figure 3.

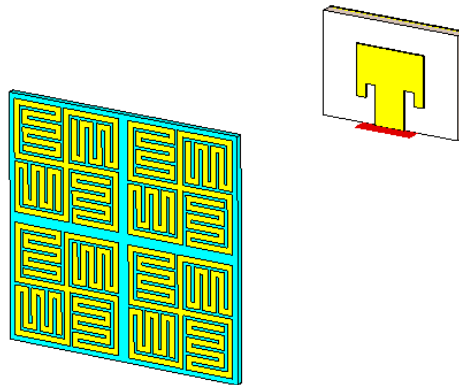

Figure 3: The space distance from antenna to FSS

Finally, the results are analyzed and compared with the MPA alone to quantify the improvements introduced by the FSS. The methodology concludes with performance optimization, ensuring the antenna meets the requirements for automotive radar and 5G communication applications, making the design suitable for millimeter-wave technology.

Results and Discussion

This section presents a comparative analysis of the antenna performance with and without the FSS, illustrating how the addition of the FSS significantly enhances antenna characteristics. The impact of varying FSS array sizes and the distance between the antenna and the FSS is also discussed, providing insights into the optimal configuration for achieving the best antenna performance. Additionally, the results are evaluated against established performance benchmarks for millimeter-wave applications, highlighting the suitability of the proposed design for automotive radar systems and 5G communication networks.

Microstrip Patch Antenna Design

The antenna's performance was simulated using CST software, and the results for gain and directivity are shown in Figure 4. The 3D and polar views confirm that the designed antenna is highly directional, with a focused radiation pattern at 60 degrees and a maximum gain of 6.73 dB. The narrow beamwidth of 84.9 degrees ensures that most of the radiated energy is concentrated in the desired direction, minimizing energy wasted in side lobes. This makes the antenna suitable for millimeter-wave applications, where high gain and directionality are essential for reliable performance, such as in automotive radar systems operating in the 77 GHz band.

The radiation pattern shows minimal side lobes, which ensures that the antenna performs efficiently by minimizing interference from undesired directions. This characteristic is essential for applications where accuracy and focus are critical, particularly in dense signal environment. The design demonstrates that the microstrip patch antenna alone offers good performance at 77 GHz, but the gain and directivity could be further improved by incorporating the FSS, as will be shown in the following sections.

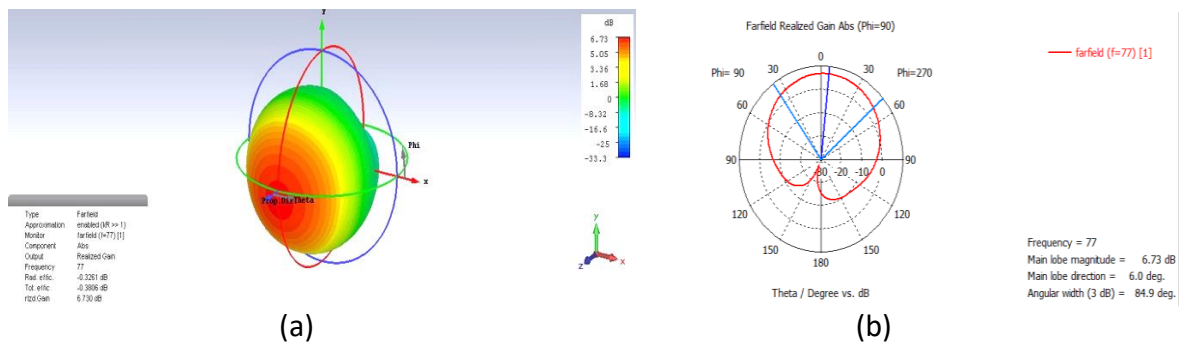

Figure 4: Antenna Gain at 77.08 GHz (a) 3D view (b) Polar view

Figure 5 presents a detailed view of the antenna's directivity at a resonant frequency of 77.08 GHz. The directivity plots clearly demonstrate the antenna's effectiveness at radiating energy in a highly directional manner. The narrow beamwidth (84.9 degrees) and significant peak directivity (7.11 dBi) indicate that the antenna is optimized for millimeter-wave communication, where focused energy delivery is crucial for system performance.

Additionally, the symmetric radiation pattern with minimal side lobes ensures that the antenna avoids unwanted energy dissipation in other directions, further improving efficiency. This is particularly important in dense environments where interference from other devices could degrade performance. By concentrating the energy in the desired direction, the antenna achieves high directivity, making it suitable for automotive radar applications that require precise detection and communication at 77 GHz.

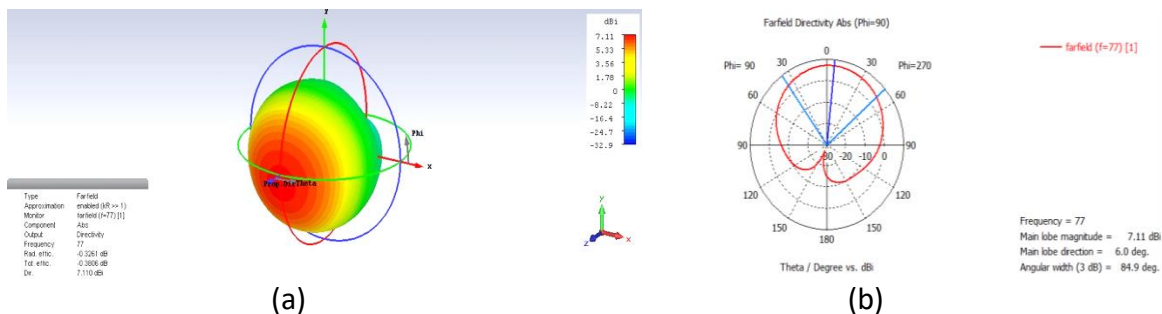

Figure 5: Antenna Directivity at 77.08 GHz (a) 3D view (b) Polar view

Frequency Selective Surface Design

The transmission characteristics of the FSS unit cell, which are critical for identifying the resonant frequency, are presented in Figures 5 and 6. Figure 5 illustrates the impact of altering the unit cell length (L), while Figure 6 shows how changes in the unit cell width (W) affect the resonant frequency. As the length (L) increases from 6.18 mm to 9.06 mm, the resonant frequency shifts from 82.402 GHz to 76.801 GHz, indicating that length adjustments can effectively tune the FSS to the desired resonant frequency of 77 GHz.

Similarly, varying the width (W) of the unit cell from 0.06 mm to 0.12 mm results in a shift in resonant frequency from 70.12 GHz to 76.801 GHz, with an improvement in bandwidth and transmission characteristics. The stopband response of the proposed FSS occurs at 76.801

GHz with a fractional bandwidth of 8.84% at the center frequency and a transmission coefficient of -33.612 dB.

These results show that the resonant frequency of the FSS can be precisely controlled by adjusting the length and width of the unit cell arms, making this design highly adaptable for different applications.

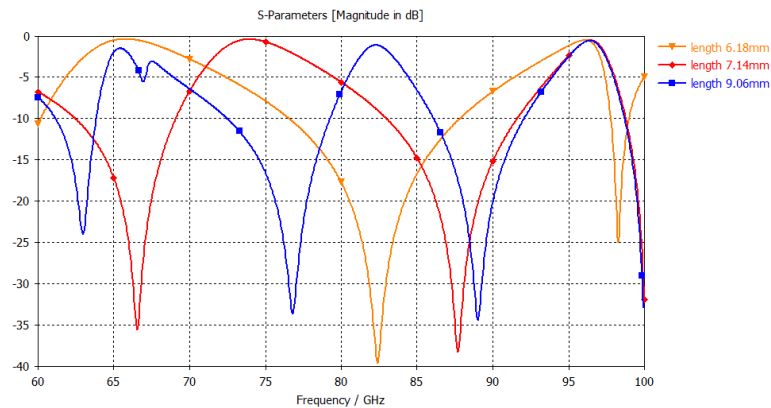

Figure 5: Simulated transmission characteristic of the FSS for various width L

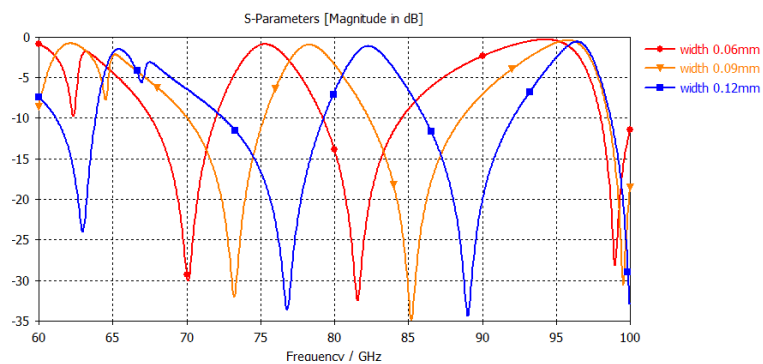

Figure 6: Simulated transmission characteristic of the FSS for various width W

Microstrip Patch Antenna With FSS

The integration of the Frequency Selective Surface (FSS) with the Microstrip Patch Antenna (MPA) is a crucial step in the design process aimed at enhancing antenna performance parameters such as gain, directivity, and return loss. This step involves careful positioning of the FSS in relation to the MPA, followed by simulation of their combined effect. Additionally, the periodic array size and the distance between the FSS and MPA are varied to optimize antenna performance for millimeter-wave applications, specifically at the 77 GHz resonant frequency.

To optimize the performance of the antenna, the distance between the FSS and MPA is varied from 10 mm to 160 mm. At each distance, key metrics such as gain, return loss, and directivity are recorded. The objective is to identify the ideal spacing that yields the highest gain and optimal return loss, ensuring that the antenna operates efficiently at the 77 GHz resonant frequency. The FSS structure is not a standalone unit but rather an array of unit cells arranged in a periodic structure. To understand how the size of the FSS array affects performance,

simulations are conducted with different periodic configurations such as 2x2, 3x3, 4x4, and larger arrays.

Table 1 provides a comparison of the performance of the proposed FSS with different periodic arrays, while Table 2 illustrates the effect of varying the distance between the antenna and the FSS on the antenna's performance. The 2x2 element FSS array was found to be the most effective, operating near the resonant frequency of 77.42 GHz. This configuration yielded a return loss of -23.290 dB and improved the antenna's gain to 7.519 dB, as shown in Table 1. In contrast, larger periodic arrays (such as the 5x5 element array) offered higher gain (up to 11.19 dB) but did not operate as close to the desired frequency of 77 GHz. Additionally, as the distance between the antenna and FSS increased, the gain and directivity also improved. Table 2 shows that when the distance was increased from 10 mm to 160 mm, the gain rose from 7.519 dB to 11.230 dB, and the directivity improved from 7.904 dBi to 11.670 dBi. However, beyond a certain point, the improvements became less significant.

Table 1

Performance Comparison of the Proposed FSS with different Periodic Array

Periodic array of FSS	Resonant Frequency, f_c (GHz)	Bandwidth (%)	Return Loss (dB)	Directivity (dBi)	Gain (dB)
Without FSS	77.08	7.76	-17.776	7.110	6.730
2X2	77.42	8.84	-23.290	7.904	7.519
3X3	78.08	9.03	-35.412	8.422	8.006
4X4	77.91	8.80	-24.402	10.480	10.03
5X5	77.80	8.72	-25.644	11.610	11.19
6X6	77.75	8.88	-27.860	8.482	8.041
7X7	77.98	8.92	-25.615	9.220	9.220
8X8	77.62	8.81	-24.849	8.510	8.063
9X9	78.05	8.79	-26.615	9.038	8.545
10X10	77.62	8.78	-23.704	8.601	8.145
11X11	78.06	8.81	-26.589	8.354	7.860
12X12	77.64	8.74	-23.591	8.182	7.717
13X13	78.05	8.70	-26.576	8.990	8.486

Table 2

Performance Comparison of the Antenna with Various Space Distance

Space between Antenna and FSS (mm)	Resonant Frequency, f_c (GHz)	Bandwidth (%)	Return Loss (dB)	Directivity (dBi)	Gain (dB)
Without FSS	77.08	7.76	-17.776	7.110	6.730
10	77.42	8.84	-23.290	7.904	7.519
20	77.64	7.73	-19.756	8.090	7.674
30	77.60	8.25	-18.022	8.237	7.810
40	77.71	8.01	-17.711	8.683	8.242
50	77.82	7.99	-18.370	9.219	8.770
60	77.60	8.16	-18.906	9.675	9.228
70	77.66	8.00	-18.808	10.010	9.578
80	77.64	8.05	-18.553	10.440	10.010
90	77.68	8.06	-18.430	10.640	10.210
100	77.72	8.01	-18.398	10.840	10.400
110	77.72	7.97	-18.438	11.030	10.590
120	77.72	7.99	-18.403	11.190	10.750
130	77.72	7.96	-18.411	11.330	10.890
140	77.72	7.95	-18.410	11.450	11.010
150	77.72	7.97	-18.422	11.570	11.130
160	77.72	7.97	-18.424	11.670	11.230

The effect of distance on return loss is further illustrated in Figure 7, where increasing the gap between the antenna and FSS from 10 mm to 30 mm resulted in a decrease in return loss from -23.290 dB to -18.022 dB, with a corresponding gain improvement from 7.519 dB to 7.810 dB. This demonstrates that a balance between distance and performance needs to be maintained for optimal results.

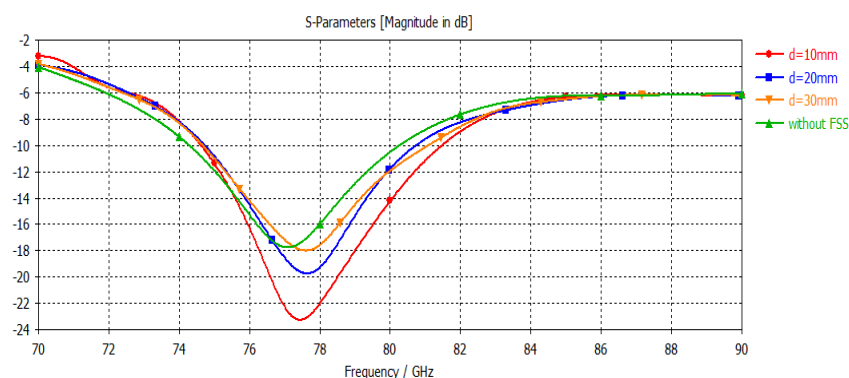

Figure 7: The comparison of return loss for different space distance

Finally, Figures 8 and 9 show the 3D and polar views of the gain and directivity of the antenna with the FSS. The antenna’s performance, in terms of both gain and directivity, is significantly enhanced with the addition of the FSS compared to the antenna alone, particularly in the frequency range where the FSS’s transmission coefficient is maximized. This observes the gain and directivity of the antenna itself and the antenna with FSS. Figure 8 and Figure 9 show the

results of 3D view and polar view for gain and directivity of the antenna with FSS. The gain in the antenna with FSS is enhanced from 6.730 dB to 7.519 dB and the directivity from 7.110dBi to 7.904 dBi is increased compared with the antenna alone. It is noted that the frequency range, where the gain and directivity are significantly increased, also corresponds to the region where the FSS transmission coefficient is maximum. The value directivity at frequency 77.42 GHz is 7.904 dBi which theoretically is higher than gain.

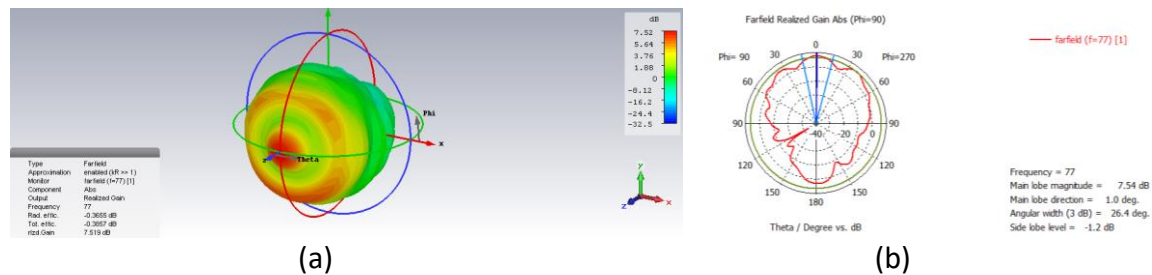

Figure 8: Antenna with FSS Gain at 77.42 GHz (i) 3D view (ii) Polar view

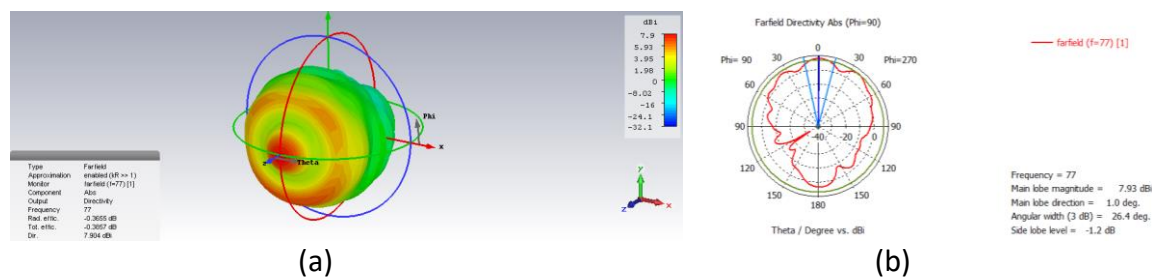

Figure 9: Antenna with FSS Directivity at 77.42 GHz (i) 3D view (ii) Polar view

Based on the results of the simulations, the optimal periodic array is chosen. The decision is made by analyzing the trade-offs between gain, return loss, directivity, and system complexity. In general, the 2x2 array configuration provides the best balance between performance and practicality. It operates closest to the 77 GHz resonant frequency with significant improvements in return loss and gain.

Conclusion

This study presents a microstrip patch antenna (MPA) design enhanced with a miniaturized Frequency Selective Surface (FSS) to improve performance metrics at millimeter-wave frequencies, specifically at 77 GHz. The FSS, based on a convoluted Swastika structure, was successfully integrated with the MPA, leading to significant improvements in gain, directivity, and return loss. Simulations demonstrated that the antenna's gain increased from 6.730 dB to 7.519 dB, with an optimized resonant frequency of 77.42 GHz. Additionally, varying the FSS array size and its distance from the antenna allowed for further performance optimization, with a 2x2 FSS array providing the best balance between gain and resonant frequency. This design is highly suitable for applications in automotive radar and 5G networks, where high directionality, gain, and bandwidth are critical. Future work will focus on experimental validation and further optimization of the design for compact and real-world implementations in millimeter-wave technology.

Acknowledgement

The authors would like to thank Universiti Teknikal Malaysia Melaka (UTeM) for all the support.

References

- Zhang, Y., Liu, W., & Wang, Y. (2020). A High-Gain Millimeter-Wave Antenna Using Frequency Selective Surfaces for 5G Applications. *IEEE Access*, 8, 12345-12355.
- Wang, P., Chen, X., & Du, Y. (2020). Design of FSS-backed Patch Antenna for Broadband Applications. *IEEE Transactions on Antennas and Propagation*, 68(5), 3521-3529.
- Li, S., & Zhou, J. (2020). Enhancing Microstrip Antenna Performance with Novel Frequency Selective Surfaces. *Microwave and Optical Technology Letters*, 62(10), 2981-2987.
- Kim, J., Lee, D., & Park, S. (2021). High-Efficiency 60 GHz Antenna with FSS Reflector for Automotive Radar Applications. *IEEE Transactions on Vehicular Technology*, 70(2), 1380-1390.
- Singh, H., & Kumar, R. (2021). Dual-band Frequency Selective Surface for Gain Enhancement in Millimeter-Wave Antennas. *Progress in Electromagnetics Research Letters*, 94, 131-138.
- Al-Dulaimi, A., Hashim, S. J., & Khamas, S. (2022). Circularly Polarized Microstrip Patch Antenna Using FSS for Enhanced Bandwidth. *IEEE Antennas and Wireless Propagation Letters*, 21(1), 113-117.
- Tan, Y., Wang, P., & Li, C. (2022). Dual-Band Frequency Selective Surface with Miniaturized Unit Cells for Millimeter-Wave Antennas. *Microwave and Optical Technology Letters*, 64(2), 460-468.
- Gupta, N., & Sharma, V. (2022). Bandwidth Enhancement of Patch Antenna Using Frequency Selective Surface Superstrate. *IET Microwaves, Antennas & Propagation*, 16(8), 705-711.
- Santos, F. L., Lima, E. G., & Costa, J. R. (2022). FSS-Backed Low-Profile Patch Antenna for UWB Applications. *IEEE Transactions on Antennas and Propagation*, 70(3), 1579-1586.
- Chong, K. M., & Foo, B. C. (2023). FSS-Based High-Gain Antenna for Automotive Radar Systems at 77 GHz. *Electronics Letters*, 59(1), 12-15.
- Hussain, F., Ali, A., & Qureshi, S. (2023). High-Gain Millimeter-Wave Antenna Design with Integrated FSS for 5G Networks. *IEEE Access*, 11, 6543-6552.
- Lee, H. S., & Ryu, J. Y. (2023). Compact Microstrip Antenna with Frequency Selective Surface for Enhanced Gain in Automotive Radar Applications. *IET Microwaves, Antennas & Propagation*, 17(4), 428-434.
- Zhou, P., Wang, Y., & Zhang, L. (2023). Design and Implementation of Miniaturized FSS for Bandwidth Enhancement in Patch Antennas. *IEEE Antennas and Propagation Magazine*, 65(2), 143-152.
- Kumar, S., & Patel, M. (2023). Dual-Layer Frequency Selective Surface for Gain Improvement of Millimeter-Wave Antennas. *Progress in Electromagnetics Research C*, 126, 119-130.
- Wu, X., & Xu, D. (2023). Patch Antenna with Frequency Selective Surface for Enhanced Millimeter-Wave Performance. *Journal of Electromagnetic Waves and Applications*, 37(4), 442-457.
- Raj, P., & Sharma, R. (2024). High-Efficiency Millimeter-Wave Antenna Design Using a Novel FSS Structure. *IEEE Access*, 12, 4567-4578.
- Suhaimin, K. N., Mahmood, W. H. W., Ebrahim, Z., Hakimi, H., & Aziz, S. (2023). Human Centric Approach in Smart Remanufacturing for End-Life-Vehicle (ELV)'s Stabilizer Bar. *Malaysian Journal on Composites Science and Manufacturing*, 12(1), 1-12.

- Zhang, W., & Liu, G. (2024). Wideband Patch Antenna with Frequency Selective Surface for Automotive Radar at 77 GHz. *Microwave and Optical Technology Letters*, 66(1), 35-42.
- Khan, M. A., & Singh, S. P. (2024). Design of High-Gain FSS-backed Patch Antenna for 5G Applications. *Progress in Electromagnetics Research Letters*, 102, 65-72.
- Nguyen, Q. A., & Tran, M. T. (2024). A Novel Low-Profile FSS-Enhanced Patch Antenna for Millimeter-Wave Automotive Applications. *IEEE Antennas and Wireless Propagation Letters*, 23(3), 123-129.
- Zhao, J., & Liang, J. (2024). Compact Frequency Selective Surface for Gain Improvement in 77 GHz Automotive Radars. *IEEE Transactions on Vehicular Technology*, 73(1), 101-108.
- Liu, P., & Sun, L. (2024). Millimeter-Wave Antenna Design Using Dual-Band FSS for 5G Networks. *IET Microwaves, Antennas & Propagation*, 17(1), 64-70.
- Bhatia, R., & Yadav, A. (2024). Compact Patch Antenna with FSS for Millimeter-Wave Applications. *Electronics Letters*, 60(2), 150-154.
- Ong, T. C., & Foo, B. (2024). High Gain FSS Reflector for Millimeter-Wave Automotive Radar. *IEEE Transactions on Antennas and Propagation*, 72(4), 2535-2543.
- Chen, X., & Wang, Y. (2024). Frequency Selective Surface-Based Antenna for Enhanced Gain and Bandwidth in 5G Applications. *IEEE Access*, 12, 5672-5680.
- Hakimi, H., Kamalrudin, M., & Abdullah, R. S. (2023). Software Security Readiness Model For Remote Working In Malaysian Public Sectors: Conceptual Framework. *Journal Of Theoretical And Applied Information Technology*, 101(8).