

Optimal Cooperative MIMO Scheme in Wireless Sensor Networks

M. Riduan Ahmad¹, Eryk Dutkiewicz², Xiaojing Huang³ and M. Kadim Suaidi⁴

^{1,4}Universiti Teknikal Malaysia Melaka, ²Macquarie University, ³CSIRO ICT Centre

^{1,4}Malaysia, ^{2,3}Australia

1. Introduction

Cooperative Multiple-Input Multiple-Output (MIMO) has been proposed as a transmission strategy to combat the fading problem in Wireless Sensor Networks (WSNs) to reduce the retransmission probability and lower the transmission energy. Among the earliest work on cooperative MIMO in WSNs is the analysis of the Space-Time Block Coding (STBC) scheme to achieve lower Bit Error Rate (BER) and significant energy savings. The work is continued with the implementation of the Low-Energy Adaptive Clustering Hierarchy (LEACH) Medium Access Control (MAC) protocol for clustered-based architectures. The combination of STBC and the LEACH scheme resulted in a significant improvement in transmission energy efficiency compared to the Single-Input Single Output (SISO) scheme.

Further study is conducted to compare the performance of STBC and various Spatial Multiplexing (SM) schemes such as Vertical Bell Labs Layered Space-Time (V-BLAST) and Diagonal BLAST. In this study, LEACH MAC was also utilized and lower transmission energy and latency were achieved against the SISO scheme. However, the centralized architecture leads to energy wastage and higher latency compared to a distributed architecture. On the other hand, the implementation of a distributed architecture needs to consider synchronisation issues. Thus a practical cooperative MIMO scheme for distributed asynchronous WSNs is needed.

Moreover, a practical MAC that can suit cooperative transmission is required. A combination of a practical MAC protocol and an efficient MIMO scheme for asynchronous cooperative transmission leads to a more energy efficient and lower latency cooperative MIMO system. A combination of a MAC protocol and a cooperative SM scheme for cooperative MIMO transmission has been proposed in previous study where the combined scheme achieves significant energy efficiency and lower latency.

Furthermore, a transmit Maximum Ratio Combiner (MRC) scheme is suggested to be more tolerant to the jitter difference than the Alamouti STC scheme in network with imperfect transmitting nodes synchronisation. In this chapter, we expand these studies to two other cooperative MIMO schemes, namely Beamforming (BF) and STBC for both network scenarios: perfect and imperfect transmitting nodes synchronisation. The optimal cooperative MIMO scheme combined with an appropriate MAC protocol should lead to the lowest energy consumption and lowest packet latency.

The rest of this chapter is organised as follows. Section 2 describes the system model considered in this chapter. Section 3 and Section 4 model the system performance and are followed by Section 5 presenting the analytical results for the three cooperative MIMO schemes (BF, SM and STBC) in terms of total energy consumption and packet latency. Finally the chapter is concluded in Section 6.

2. System Model

The baseline system for cooperative MIMO communication is equipped with a CMA_{CON} protocol as proposed and evaluated in (Yang et. al., 2007). Sleep cycles are not implemented in order to ensure that the cooperative nodes are always available to perform cooperative transmission and reception. In order to avoid collision, we assume that during the cooperative transmission and reception, other nodes in the vicinity that are not involved in the transmission are put in the silent mode for the whole transmission duration. The duration to remain silent is obtained from the Network Allocation Vector (NAV).

Also in this chapter we consider the impact of imperfect synchronisation caused by clock jitter alone. Each cooperative transmitting node experiences clock jitter with the jitter around a reference clock, T_o denoted as T_j^m where $1 \leq m \leq M$. The worst case scenario is considered here with only 2 cooperative transmitting nodes where the clock jitters are fixed at the extreme ends, $T_j^1 = -\frac{\Delta T_b}{2}, T_j^2 = +\frac{\Delta T_b}{2}$ where $0 \leq \Delta T_b \leq T_b$ and T_b is the bit

duration. Thus the clock jitters difference is $\Delta T_j = T_j^1 - T_j^2 = \Delta T_b$. The effect of imperfect synchronisation can be modelled as a degrading function of the bit period which consequently degrades the received bit energy.

The baseline network configurations for MISO BF and STBC are shown in Figures 1 and 2 while for MIMO SM it is shown in Figure 3. The network is assumed to be distributed without any infrastructure and the nodes are fixed once they are deployed. A new node that wants to join the network should broadcast a packet after powering up to acknowledge its presence in the neighbourhood. A node checks its remaining energy regularly and when its total remaining energy is below the threshold, which indicates that its death is near, it informs the other nodes in the vicinity of the expected death time. Therefore the neighbouring nodes will exclude this node from any future cooperative MIMO transmission. The distance between the cooperating nodes either at the transmitting or receiving side is assumed to be very small compared to the distance between the source node and the destination node, d . We assume that there are M cooperative transmitting nodes and one receiving node for the perfect synchronisation scenario and $M = 2$ cooperative transmitting nodes and one receiving node for the imperfect synchronisation scenario. A special case for the spatial multiplexing scheme is used where the number of the cooperative receivers is assumed to be N .

In this section, we introduce two kinds of network configurations. The first network configuration involves data transmission from M cooperating transmitting nodes to one destination node by utilizing either of the two MIMO schemes: BF or STBC. An RTS-CTS handshaking method is performed as described in (Yang et. al., 2007) and the source node broadcasts the original data packet to its $M-1$ neighbours.

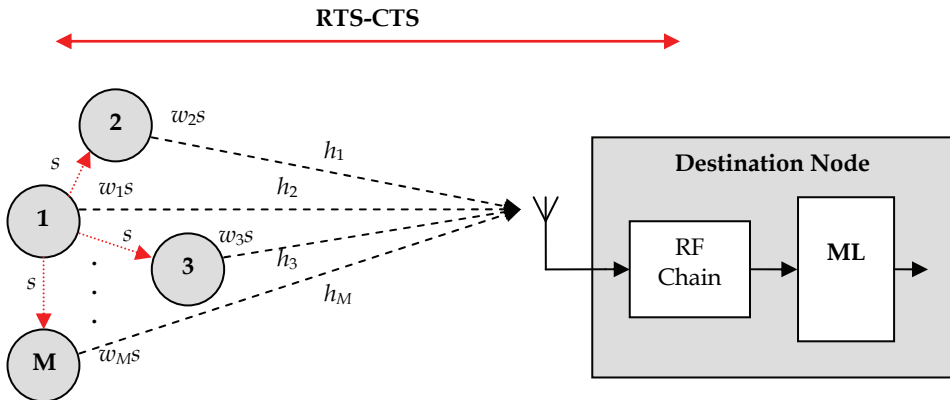

Fig. 1. A cooperative beamforming transmit diversity system with M transmit nodes and 1 destination.

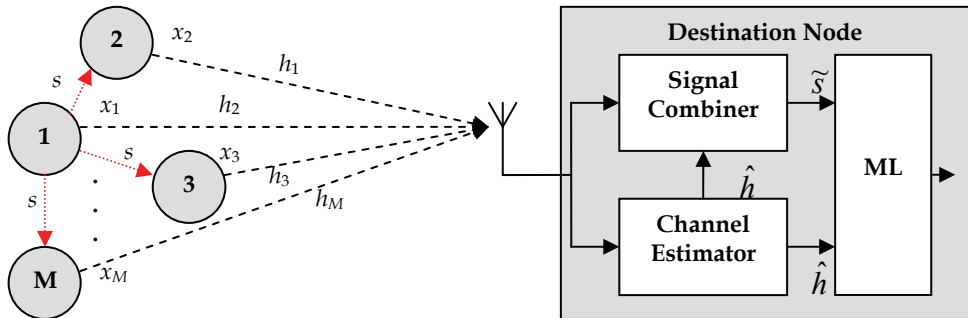

Fig. 2. A cooperative STBC transmit diversity system with M transmit nodes and 1 destination.

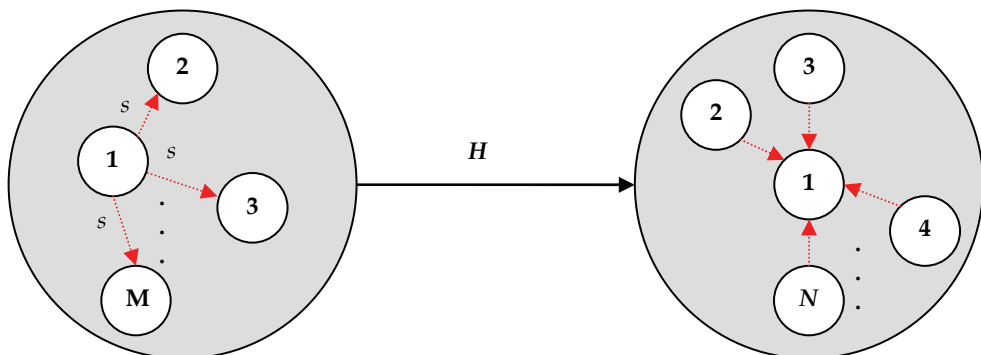

Fig. 3. A cooperative spatial multiplexing system with M transmit nodes and N receive nodes. In the case of the BF scheme, the channel information is estimated and optimized from the CTS packet by all the M nodes in order to weight the data packet. In the case of the STBC

scheme, all the M nodes encode the original data packet with the information supplied by the source node in the broadcast packet. Both schemes utilize a Maximum Likelihood (ML) detector and a coherent receiver is used. The second network configuration is the data transmission from M cooperating transmitting nodes to N cooperating receiving nodes by utilizing the concept of SM. The recovered data from $N-1$ nodes is forwarded to the destination node.

3. Energy Consumption Performance Analysis

The energy consumed by a sensor node can be categorized into two major parts (Cui et. al, 2004; Nguyen et. al., 2007): energy expended during running the transceiver circuits, P_c and energy expended during packet transmission, P_t . Therefore, both energy components must be considered when comparing the total energy consumption of cooperative MIMO and SISO transmission schemes. All the nodes in vicinity that are not involved in the transmission and reception are assumed to be in the sleep mode. Also for simplicity, the energy consumed during the transient mode from the sleep mode to the active mode and by the digital signal processing blocks is neglected.

3.1 SISO System

To model transmission energy for the non-cooperative or SISO system, we start with the power consumed by the power amplifier, P_{pa} . As given in (Cui et. al., 2004; Nguyen et. al., 2007), P_{pa} is dependent on the transmit power P_t and can be approximated as:

$$P_{pa} = (1 + \alpha)P_t \quad (1)$$

where $\alpha = \frac{\xi}{\eta} - 1$ with ξ denoting the drain efficiency of the Radio Frequency (RF) power amplifier and η denoting the Peak-to-Average Ratio (PAR) which depends on the modulation scheme and the associated constellation size. The total circuit power is given by:

$$P_c \approx (M \times P_{ct}) + (N \times P_{cr}) \quad (2)$$

where $P_{cr} = P_{LNA} + P_{mix} + P_{IFA} + P_{filr} + P_{ADC} + P_{syn}$ and $P_{ct} = P_{DAC} + P_{mix} + P_{filt} + P_{syn}$ are values for the power consumption of the Digital-to-Analogue Converter (DAC), mixer, Low Noise Amplifier (LNA), Intermediate Frequency Amplifier (IFA), active filters at the transmitter and the receiver, Analogue-to-Digital Converter (ADC) and frequency synthesizer whose values and a detailed block diagram are given in (Cui et. al., 2004; Nguyen et. al., 2007). Therefore, the total energy consumption per bit E_{bt} for the SISO system can be obtained as:

$$E_{bt} = \frac{(P_{pa} + P_c)}{R_b} \quad (3)$$

when $M = N = 1$. Equations (1) and (2) can be used to model the cooperative BF, STBC and SM systems with an arbitrary number of M and N . For the traditional Carrier Sense Multiple Access with Collision Avoidance (CSMA-CA) protocol, the energy consumed for an unsuccessful transmission attempt is given as:

$$E_{u_siso} = E_{rts} + E_{cts} + E_{data_siso} \quad (4)$$

and that for a successful attempt is given as:

$$E_{s_siso} = E_{rts} + E_{cts} + E_{data_siso} + E_{ack} \quad (5)$$

where E_{rts} , E_{cts} , E_{data_siso} , E_{ack} are the energy consumed while sending Ready-to-Send (RTS), Clear-to-Send (CTS), SISO data and Acknowledgment (ACK). Given the size of each packet as N_{rts} , N_{cts} , N_{data_siso} and N_{ack} , Equations (4) and (5) can be rewritten as:

$$E_{u_siso} = E_{bt} (N_{rts} + N_{cts} + N_{data_siso}) \quad (6)$$

$$E_{s_siso} = E_{bt} (N_{rts} + N_{cts} + N_{data_siso} + N_{ack}). \quad (7)$$

The expected total energy consumption is given as:

$$E_{siso} = \left(\frac{P_{psiso}}{1 - P_{psiso}} \right) E_{u_siso} + E_{s_siso} \quad (8)$$

where P_{psiso} is the packet error probability of the SISO system which can be obtained in (Ahmad et. al., 2008)

3.2 Cooperative MIMO System

In this sub-section, we consider two scenarios where the first scenario involves transmission from M cooperating transmitting nodes to 1 destination node with a local exchange of information at the transmitting side. This scenario applies to the cooperative MISO BF and STBC schemes. The second scenario deals with transmissions from M cooperating transmitting nodes to N receiving nodes with local exchanges at both the transmitting and receiving sides. This scenario applies to the cooperative MIMO SM scheme.

To model transmission energy for the first scenario, we start with the power consumed by the power amplifier, P_{paBs} during a local exchange between the source node and its cooperating neighbours. P_{paBs} is dependent on the local exchange transmitted power P_{tm} and can be approximated as:

$$P_{paBs} = (1 + \alpha) P_{tm}. \quad (9)$$

The total circuit power for the local exchange is given by:

$$P_{cBs} \approx P_{ct} + (M - 1) \times P_{cr}. \quad (10)$$

Therefore the total energy consumption per bit E_{btBs} for the local exchange can be obtained as:

$$E_{btBs} = \frac{(P_{paBs} + P_{cBs})}{R_b}. \quad (11)$$

The energy consumed for an unsuccessful BF and STBC transmissions attempt is given as:

$$E_{u_M} = E_{rts} + E_{cts} + E_{Bs} + M \cdot E_{data_M} \quad (12)$$

and that for a successful attempt is given as:

$$E_{s_M} = E_{u_M} + E_{ack} \quad (13)$$

where E_{Bs} and E_{data_M} are the amounts of energy consumed during packet broadcasting from the source node to its neighbours and the energy consumed for Cooperative BF or STBC data transmission. Given the size of each packet as N_{rts} , N_{cts} , N_{Bs} , N_{data_M} and N_{ack} , Equations (12) and (13) can be rewritten as:

$$E_{u_M} = E_{bt}(N_{rts} + N_{cts}) + E_{btBs}N_{Bs} + M \cdot E_{btdata_M}N_{data_M} \quad (14)$$

$$E_{s_M} = E_{u_M} + E_{bt} \times N_{ack}. \quad (15)$$

The expected total energy consumption is given as:

$$E_M = \left(\frac{P_{pM}}{1 - P_{pM}} \right) E_{u_M} + E_{s_M} \quad (16)$$

where P_{pM} is the packet error probability for BF or STBC which can be obtained in (Ahmad et. al., 2008). To model transmission energy for the second scenario, we start with the power consumed by the power amplifier, P_{paBr} from the destination node to its cooperating receiving nodes and P_{paCol} from $N-1$ receiving nodes to the destination node. P_{paBr} and P_{paCol} are dependent on the local exchange transmit power P_{tm} and can be approximated as:

$$P_{paBr} = (1 + \alpha)P_{tm} \quad (17)$$

$$P_{paCol} = (1 + \alpha)P_{tm}(N - 1). \quad (18)$$

The total circuit power for the former case is given by:

$$P_{cBr} \approx P_{ct} + (N - 1) \times P_{cr} \quad (19)$$

and the total circuit power for the latter case is given by:

$$P_{cCol} \approx (N-1) \times P_{ct} + P_{cr}. \quad (20)$$

Therefore the total energy consumption per bit E_{btBr} and E_{btCol} for both cases can be obtained as:

$$E_{btBr} = \frac{(P_{paBr} + P_{cBr})}{R_b} \quad (21)$$

$$E_{btCol} = \frac{(P_{paCol} + P_{cCol})}{R_b}. \quad (22)$$

The energy consumed for an unsuccessful SM transmission attempt is given as:

$$E_{u_SM} = E_{rts} + E_{Br} + E_{cts} + E_{Bs} + M \cdot E_{data_SM} + (N-1) \cdot E_{Col} \quad (23)$$

and that for a successful attempt is given as:

$$E_{s_SM} = E_{u_SM} + E_{ack} \quad (24)$$

where E_{Br} , E_{Col} and E_{data_SM} are the energy consumed during packet broadcasting from the destination node to its neighbours, the energy consumed by $N-1$ cooperating receiving nodes to the destination node and the energy consumed for the cooperative SM data transmission. Given the size of each packet as N_{rts} , N_{cts} , N_{Bs} , N_{data_SM} and N_{ack} , Equations (23) and (24) can be rewritten as:

$$E_{u_SM} = E_{bt} (N_{rts} + N_{cts}) + E_{btBr} N_{Br} + E_{btBs} N_{Bs} + M \cdot E_{btdata_SM} N_{data_SM} + (N-1) E_{btCol} N_{Col} \quad (25)$$

$$E_{s_SM} = E_{u_SM} + (E_{bt} \times N_{ack}). \quad (26)$$

The expected total energy consumption is given as:

$$E_{SM} = \left(\frac{P_{pSM}}{1 - P_{pSM}} \right) E_{u_SM} + E_{s_SM} \quad (27)$$

where P_{pSM} is the packet error probability of cooperative MIMO with spatial multiplexing which can be obtained in (Yang et. al., 2007). The values of the system parameters used in Figures 4 to 7 are listed in Table 1 (Cui et. al., 2004; Yang et. al., 2007).

Symbol	Quantity
N_{rts}	65 bits
N_{cts}	55 bits
N_{ack}	54 bits
N_{Bs}	1300 bits
N_{Br}	120 bits
$N_{data} = N_{Col}$	1024 bits
P_{mix}	30.3mW
P_{syn}	50mW
$P_{filt} = P_{fltr}$	2.5mW
P_{ADC}	9.85mW
P_{DAC}	15.48mW
P_{LNA}	20mW
P_{IFA}	3mW

Table 1. system parameter for energy consumption modeling

4. Packet Latency Performance Analysis

As we noted earlier, each packet transmission in cooperative transmission requires more steps which introduces more overhead. These steps may increase packet delays. However, the reduction of PER as the diversity gain increases from the cooperative MIMO exploitation can reduce the retransmissions rates which in turn can reduce packet latency. Sub-section 4.1 models packet latency performance for the non-cooperative SISO system. Comparison is then made with the models developed for the cooperative MIMO systems in Sub-section 4.2. The performance results are discussed in Section 5.

4.1 SISO System

For SISO communication, T_{rts} , T_{cts} , T_{data} and T_{ack} are the transmission periods for the RTS, CTS, DATA and ACK packets. The period with a successful transmission attempt is given as:

$$T_{s_siso} = T_{rts} + T_{cts} + T_{data} + T_{ack} \quad (28)$$

and the period with an unsuccessful transmission attempt is given as:

$$T_{u_siso} = T_{rts} + T_{cts} + T_{data} + T_{wait} \quad (29)$$

where T_{wait} is the duration for which the sender waits for an ACK packet. The packet transmission delay is then given as:

$$T_{d_siso} = \left(\frac{P_{psiso}}{1 - P_{psiso}} \right) T_{u_siso} + T_{s_siso} \quad (30)$$

4.2 Cooperative MIMO System

In addition to the delay incurred as calculated in the previous section, the broadcast packet transmission from the source node to its neighbours introduces a broadcast transmission period, T_{Bs} in cooperative BF, STBC and SM transmissions. The transmission period of cooperative BF, STBC and SM data packets is the same as that for the SISO system due to the fact that the packet size and the modulation scheme are the same. The duration of a successful transmission attempt is given as:

$$T_{s_M} = T_{rts} + T_{cts} + T_{Bs} + T_{data} + T_{ack} \quad (31)$$

and the period with an unsuccessful transmission attempt is given as:

$$T_{u_M} = T_{rts} + T_{cts} + T_{Bs} + T_{data} + T_{wait} \cdot \quad (32)$$

The expected packet transmission delay is then given by:

$$T_{d_M} = \left(\frac{P_{pM}}{1 - P_{pM}} \right) T_{u_M} + T_{s_M} \cdot \quad (33)$$

For the case of cooperative MIMO SM, we introduce the delay for the broadcast transmission time of a recruitment message sent by the destination node, T_{Br} and the delay for the time required by the cooperating receiving nodes ($N-1$) to send the data to the destination, T_{col} . The duration of a successful transmission attempt is given as:

$$T_{s_SM} = T_{s_M} + T_{Br} + T_{col} \quad (34)$$

and the period with an unsuccessful transmission attempt is given as:

$$T_{u_SM} = T_{s_SM} + T_{wait} - T_{ack} \cdot \quad (35)$$

The expected packet transmission delay is then given by:

$$T_{d_SM} = \left(\frac{P_{pSM}}{1 - P_{pSM}} \right) T_{u_SM} + T_{s_SM} \cdot \quad (36)$$

The values of the system parameters used in Figures 8 to 11 are as follows: $T_{rts} = 0.52\text{ms}$, $T_{cts} = 0.44\text{ms}$, $T_{ack} = 0.432\text{ms}$, $T_{Bs} = 10.4\text{ms}$, $T_{Br} = 0.96\text{ms}$, $T_{data} = 8.192\text{ms}$, $T_{col} = 22.3\text{ms}$ (Nguyen et al., 2007), and $T_{wait} = 70\text{ms}$ (Yang et. al., 2007).

5. Performance Results and Discussions

As shown in Figure 4, SISO is more energy efficient than the cooperative schemes at transmission powers above 100mW with any number of M and N nodes. The cooperative SM scheme suffers more in terms of energy efficiency because the total energy consumption is increasing as the diversity gain and the number of nodes M increases. The cooperative BF and STBC schemes suffer only with the increasing of the diversity gain.

As we noted earlier the cooperative schemes are more energy efficient when the transmission power is below 100mW. We can see in Figure 5, that the cooperative BF and STBC schemes outperform the cooperative SM scheme and that the cooperative BF scheme is more energy efficient than the cooperative STBC scheme with two transmitting nodes.

For imperfect synchronisation scenarios, as shown in Figure 6, in the case of equal diversity gain for all the schemes, the cooperative BF scheme is more energy efficient than the other schemes. However, as the diversity gain of the cooperative SM scheme is increased, as shown in Figure 7, cooperative SM outperforms the other schemes in terms of energy efficiency at and above $0.8T_b$ in the region of operating transmission power for WSNs (common operating transmission power is between 20mW to 60mW (Polastre et. al., 2004; Kohvakka et. Al., 2006; Kuorilehto et. al., 2007)). These results indicate that if we allow some delays to occur within a particular range during transmission, the cooperative SM scheme can achieve a significant energy saving. However, by relaxing the synchronisation algorithm with $0.4T_b$ jitters tolerance, the cooperative BF scheme can achieve the highest energy saving among the other schemes.

As shown in Figures 8 and 9, the SISO scheme outperforms the cooperative schemes at the transmission power region above 800mW. At the lower transmission power region, the three cooperative schemes outperform the SISO scheme. The cooperative SM scheme enjoys a lower transmission delay when the diversity gain is increasing with any arbitrary number of transmitting nodes with one condition that the number of cooperative SM receiving N nodes must be greater than the number of M nodes in cooperative BF and STBC. It also important to note that cooperative BF outperforms cooperative STBC when $M = 2$.

For imperfect synchronisation scenarios, as shown in Figures 10 and 11, at the lower transmission power region, the three cooperative schemes outperform the SISO scheme. The cooperative BF scheme enjoys lower packet latency and outperforms the other schemes even when the diversity gain of the cooperative SM scheme is increased.

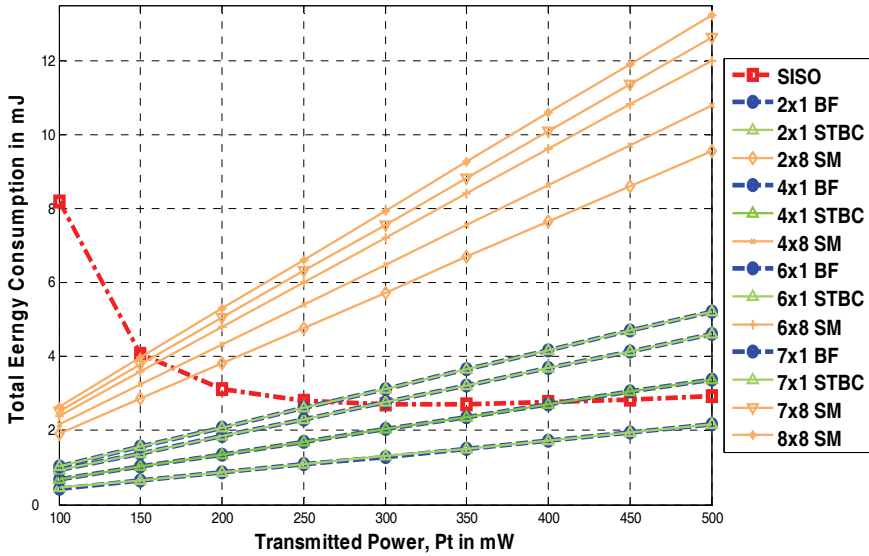

Fig. 4. Total energy consumption vs. transmission power for various schemes with $M = 2, 4, 6, 7, 8$ and $N = 1$ (Cooperative BF and STBC) and $N = 8$ (Cooperative SM).

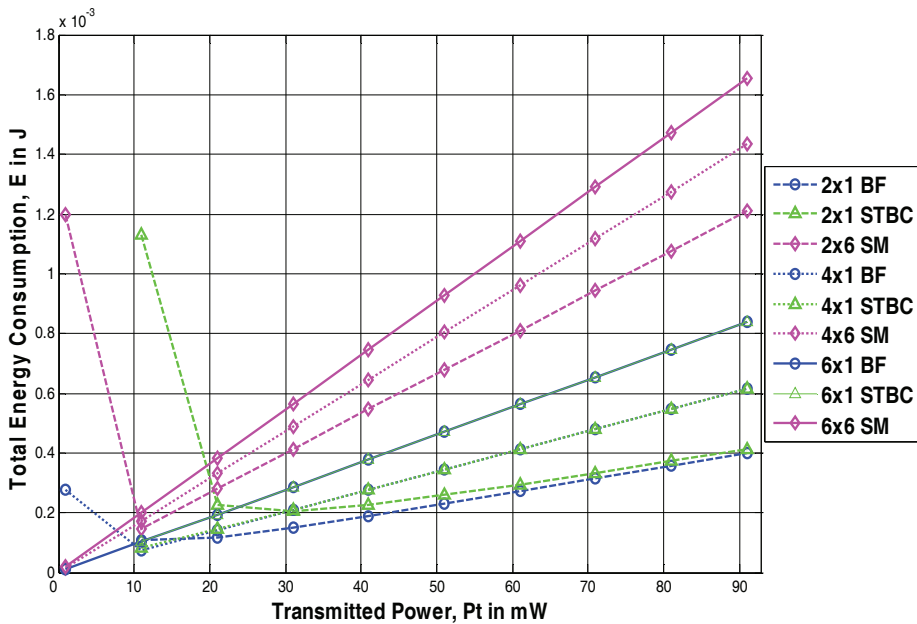

Fig. 5. Total energy consumption vs. transmission power for various schemes with $M = 2, 4, 6$ and $N = 1$ (Cooperative BF and STBC) and $N = 6$ (Cooperative SM).

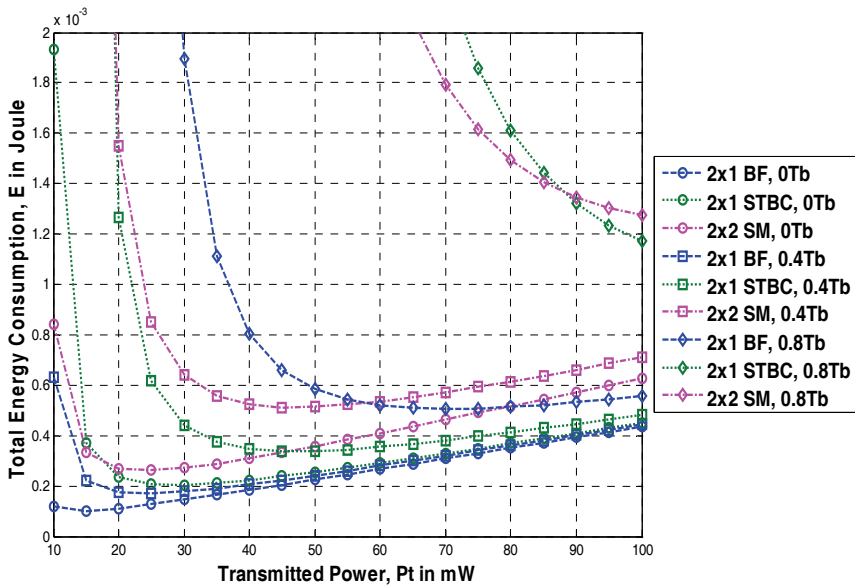

Fig. 6. Total energy consumption vs. transmission power (lower region) for various imperfect synchronisation schemes with $M = 2$ and $N = 1$ (Cooperative BF and STBC) and $N = 2$ (Cooperative SM).

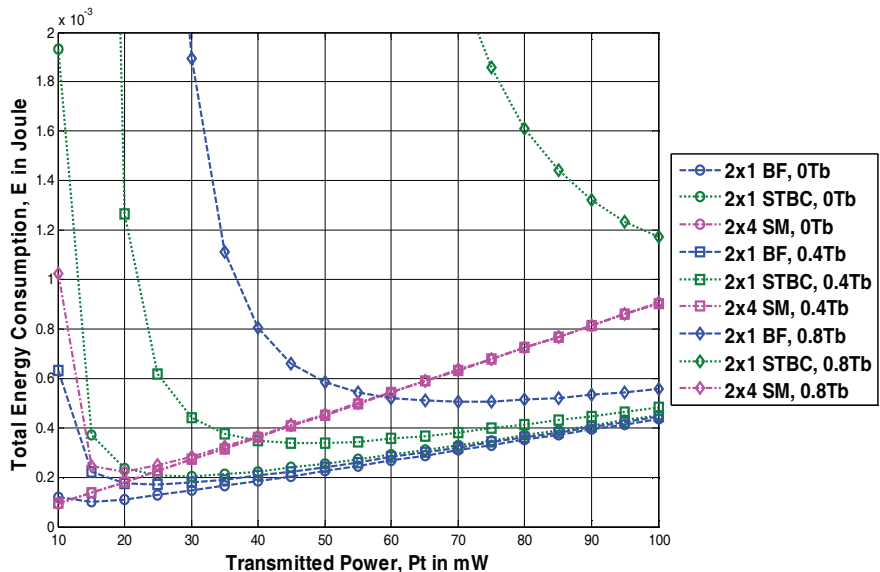

Fig. 7. Total energy consumption vs. transmission power (lower region) for various imperfect synchronisation schemes with $M = 2$ and $N = 1$ (Cooperative BF and STBC) and $N = 4$ (Cooperative SM).

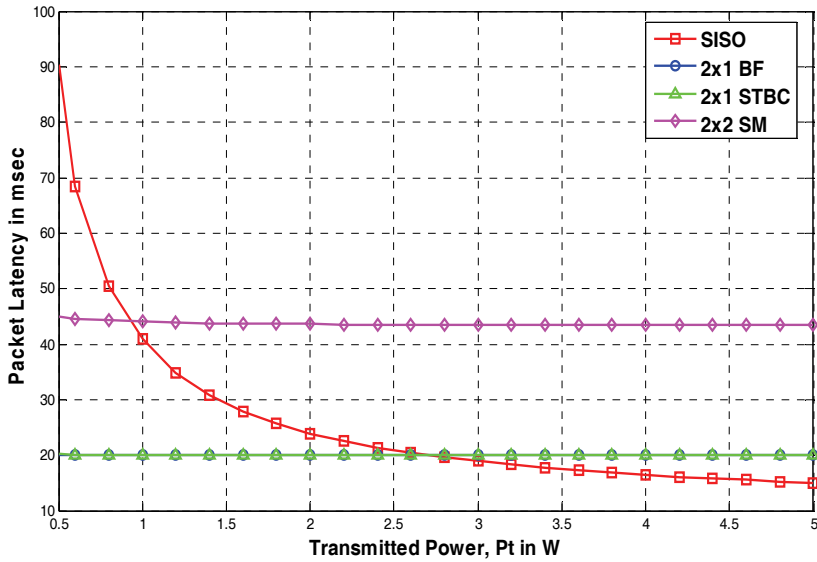

Fig. 8. Packet latency vs. transmission power for various schemes with $M = 2$ and $N = 1$ (Cooperative BF and STBC) and $N = 2$ (Cooperative SM).

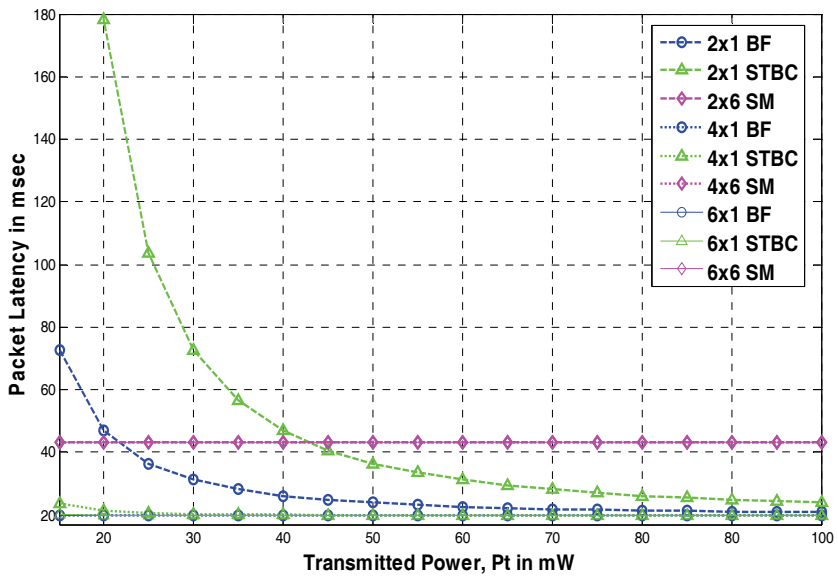

Fig. 9. Packet latency vs. transmission power for various schemes with $M = 2, 4,$ and 6 and $N = 1$ (Cooperative BF and STBC) and $N = 6$ (Cooperative SM).

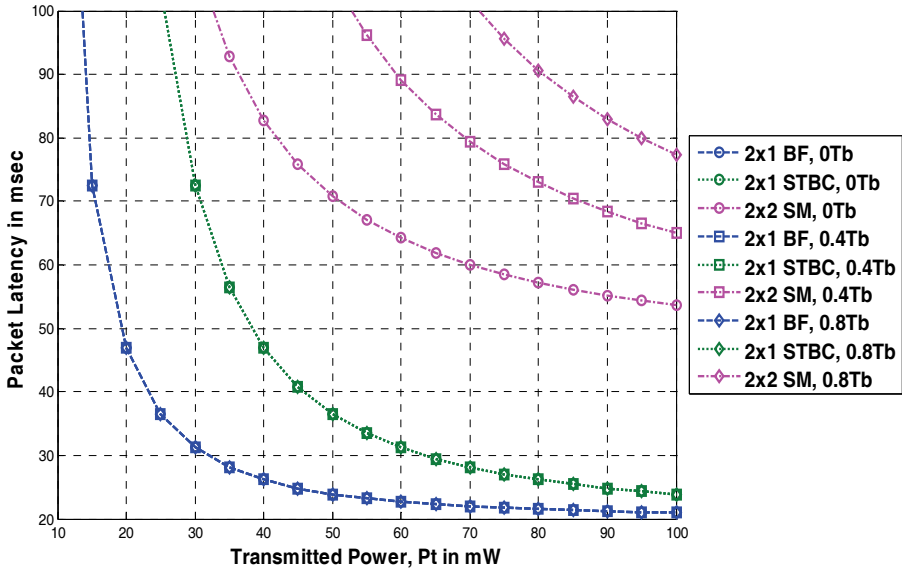

Fig. 10. Packet latency vs. transmission power (lower region) for various imperfect synchronisation schemes with $M = 2$ and $N = 1$ (Cooperative BF and STBC) and $N = 2$ (Cooperative SM).

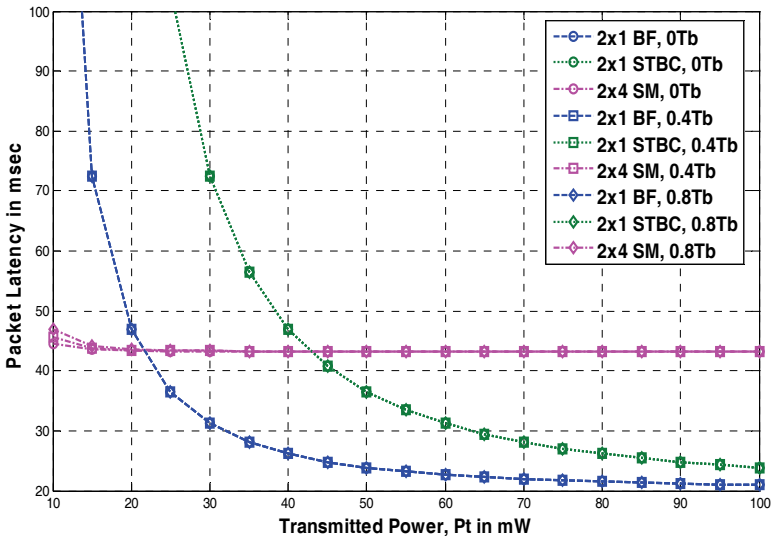

Fig. 11. Packet latency vs. transmission power (lower region) for various imperfect synchronisation schemes with $M = 2$ and $N = 1$ (Cooperative BF and STBC) and $N = 4$ (Cooperative SM).

6. Conclusion

This chapter presents a comparison study of three cooperative MIMO schemes in WSNs. We have developed analytical models for BER and PER to estimate retransmission rates from PER in (Ahmad et. al., 2008) and these are used to evaluate the total energy consumption and packet latency of the cooperative systems in this chapter. We show that the SISO scheme is more energy efficient and has lower latency at higher regions of transmission power while the three cooperative MIMO schemes are more energy efficient and outperform the SISO scheme at lower regions. Clearly, at the higher transmission power region, the SISO scheme enjoys lower transceiver circuit energy consumption and no energy cost at all on establishing a cooperative mechanism compared to the cooperative MIMO schemes. These results provide a constraint on the optimal transmission power or equivalently the optimal distance that should be used when implementing cooperative MIMO transmission in WSNs.

From the analysis we can conclude that at the lower transmission power region, the cooperative optimal BF scheme outperforms both the cooperative SM and STBC schemes in terms of energy efficiency and packet latency for both perfect and imperfect synchronisation scenarios. Also we note that the cooperative BF scheme with $M = 2$ nodes is an efficient cooperative system. Further work will involve development of MAC protocols optimised for the cooperative transmission schemes and with the aim of creating an optimal cooperative transmission mechanism for use in distributed WSNs.

7. References

- Ahmad, M.R.; Dutkiewicz, E.; & Huang, X. (2008). Performance Analysis of Cooperative MIMO Transmission Schemes in WSN, to be presented at the IEEE International Symposium on Personal, Indoor and Mobile Radio Communications (PIMRC), Cannes, France.
- Cui, S.; Goldsmith, A.J.; & Bahai, A. (2004). Energy-efficient of MIMO and Cooperative MIMO Techniques in Sensor Networks, *IEEE Journal on Selected Areas in Communications*, vol. 22, issue 6, pp. 1089-1098.
- Kohvakka, M.; Kuorilehto, M.; Hannikainen, M. & Hamalainen, T.D. (2006). Performance Analysis of IEEE 802.15.4 and Zigbee for Large-scale Wireless Sensor Network Applications, *Proceedings of ACM International Workshop on Performance Evaluation of Wireless Ad hoc, Sensor, and Ubiquitous Networks*, pp. 1-6, Malaga, Spain.
- Kuorilehto, M.; Kohvakka, M.; Suhonen, J.; Hamalainen, P.; Hannikainen, M. & Hamalainen, T.D. (2007). MAC Protocols, In: *Ultra-Low Energy Wireless Sensor Networks in Practice*, pp. 73-88, John Wiley & Sons, 978-0-470-05786-5, West Sussex, England.
- Nguyen, T.D.; Berder, O.; & Sentieys, O. (2007). Cooperative MIMO Schemes Optimal Selection for Wireless Sensor Networks, presented at IEEE Vehicular Technology Conference (VTC2007), Baltimore, MD, USA.
- Polastre, J.; Hill, J.; & Culler, D. (2004). Versatile Low Power Media Access for Wireless Sensor Networks, presented at The ACM Conference on Embedded Networked Sensor Systems (Sensys), Baltimore, Maryland, USA.
- Yang, H.; Shen, H.-Y. & Sikdar, B. (2007). A MAC Protocol for Cooperative MIMO Transmissions in Sensor Networks, *Proceedings of IEEE Global Telecommunications Conference (GLOBECOM)*, pp. 636-640, Washington, USA.

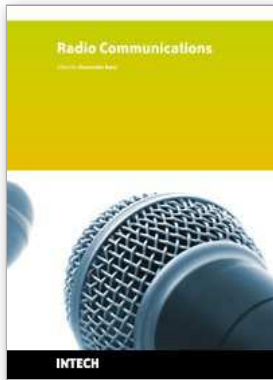

Radio Communications

Edited by Alessandro Bazzi

ISBN 978-953-307-091-9

Hard cover, 712 pages

Publisher InTech

Published online 01, April, 2010

Published in print edition April, 2010

In the last decades the restless evolution of information and communication technologies (ICT) brought to a deep transformation of our habits. The growth of the Internet and the advances in hardware and software implementations modified our way to communicate and to share information. In this book, an overview of the major issues faced today by researchers in the field of radio communications is given through 35 high quality chapters written by specialists working in universities and research centers all over the world. Various aspects will be deeply discussed: channel modeling, beamforming, multiple antennas, cooperative networks, opportunistic scheduling, advanced admission control, handover management, systems performance assessment, routing issues in mobility conditions, localization, web security. Advanced techniques for the radio resource management will be discussed both in single and multiple radio technologies; either in infrastructure, mesh or ad hoc networks.

How to reference

In order to correctly reference this scholarly work, feel free to copy and paste the following:

M. Riduan Ahmad, Eryk Dutkiewicz, Xiaojing Huang and M. Kadim Suaidi (2010). Optimal Cooperative MIMO Scheme in Wireless Sensor Networks, Radio Communications, Alessandro Bazzi (Ed.), ISBN: 978-953-307-091-9, InTech, Available from: <http://www.intechopen.com/books/radio-communications/optimal-cooperative-mimo-scheme-in-wireless-sensor-networks>

INTECH

open science | open minds

InTech Europe

University Campus STeP Ri
Slavka Krautzeka 83/A
51000 Rijeka, Croatia
Phone: +385 (51) 770 447
Fax: +385 (51) 686 166
www.intechopen.com

InTech China

Unit 405, Office Block, Hotel Equatorial Shanghai
No.65, Yan An Road (West), Shanghai, 200040, China
中国上海市延安西路65号上海国际贵都大饭店办公楼405单元
Phone: +86-21-62489820
Fax: +86-21-62489821

© 2010 The Author(s). Licensee IntechOpen. This chapter is distributed under the terms of the [Creative Commons Attribution-NonCommercial-ShareAlike-3.0 License](#), which permits use, distribution and reproduction for non-commercial purposes, provided the original is properly cited and derivative works building on this content are distributed under the same license.